

STATE LIBRARY OF PENNSYLVANIA

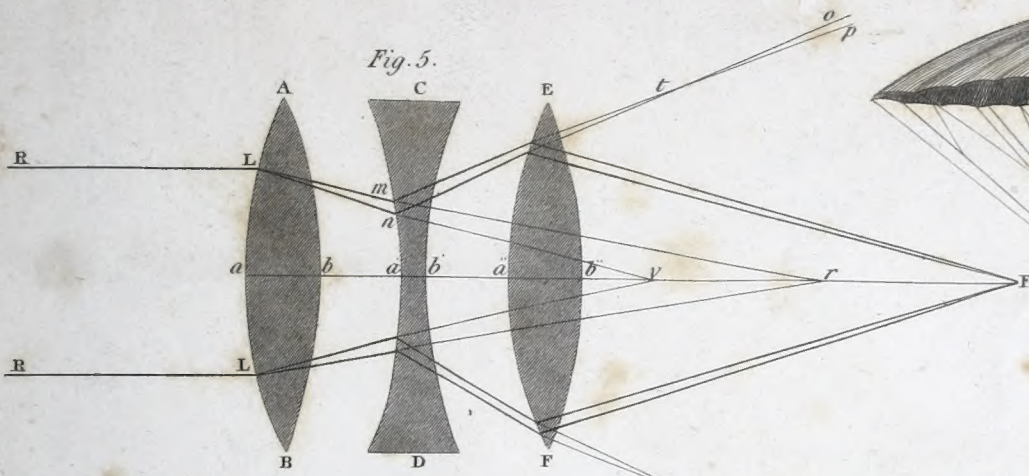


3 0144 00492402 3

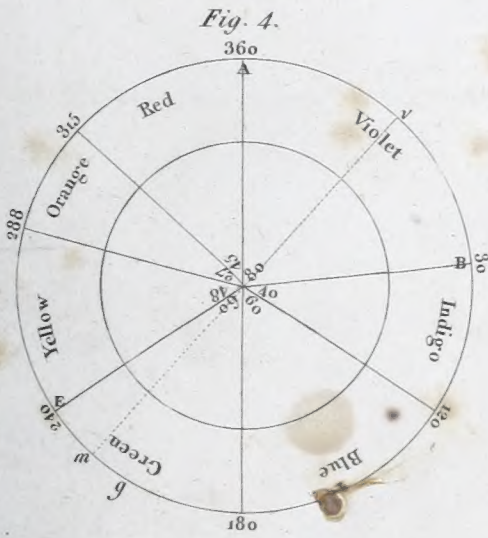


Digitized by the Internet Archive  
in 2019 with funding from

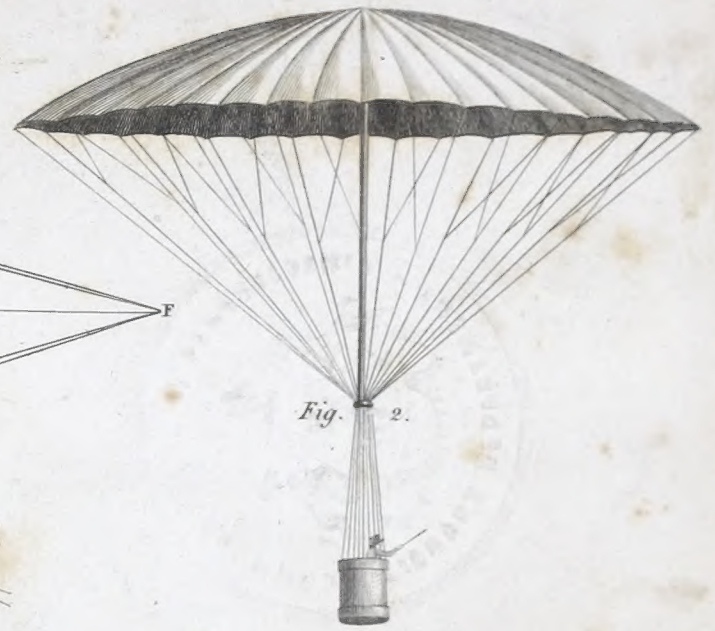
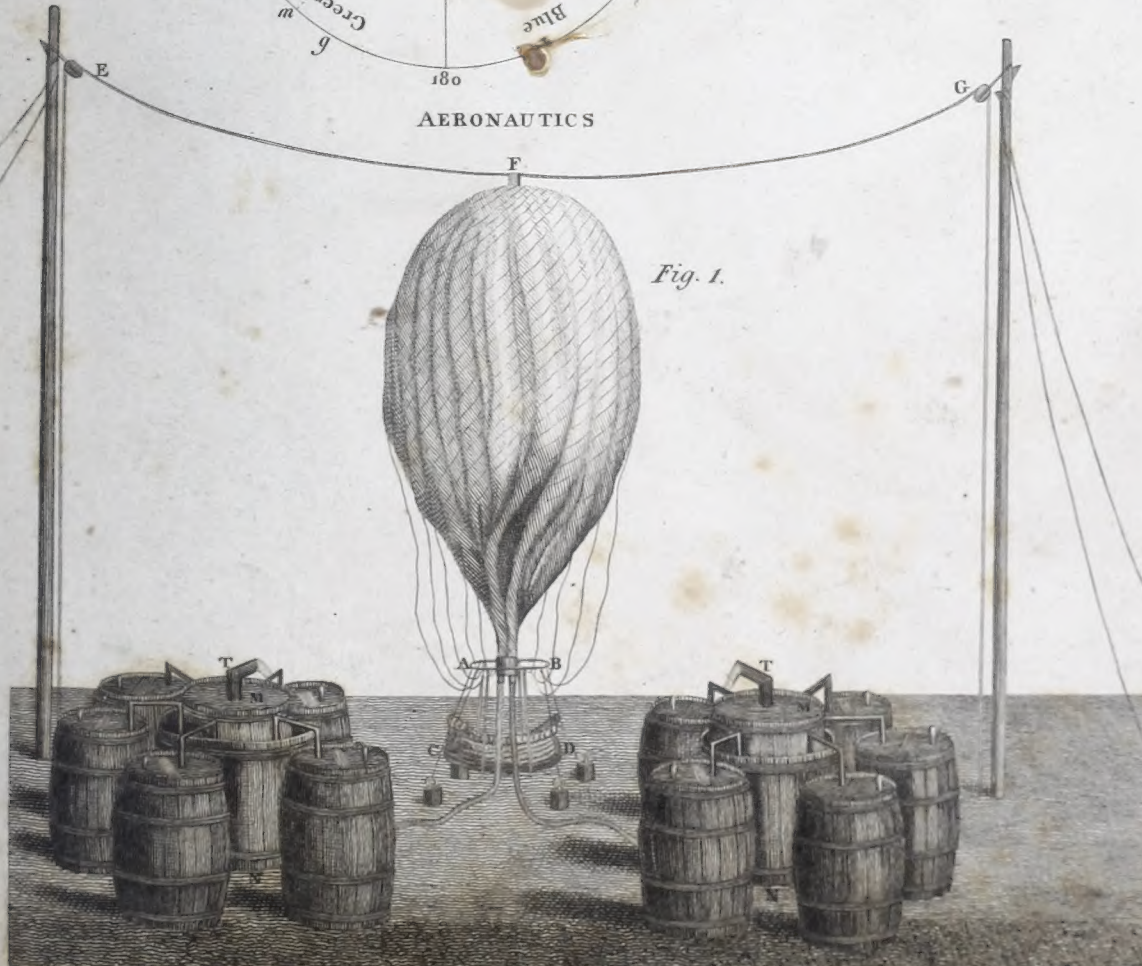
This project is made possible by a grant from the Institute of Museum and Library Services as administered by the Pennsylvania Department of Education through the Office of Commonwealth Libraries



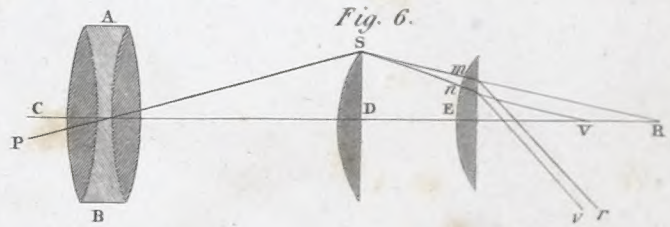
ACCIDENTAL COLOURS



AERONAUTICS

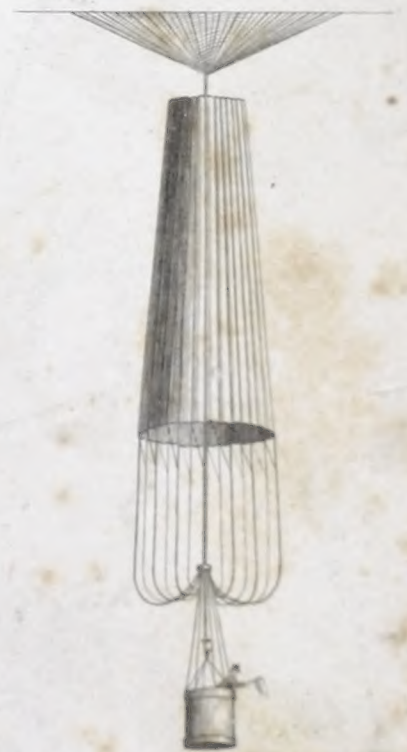


ACHROMATIC EYE-PIECE



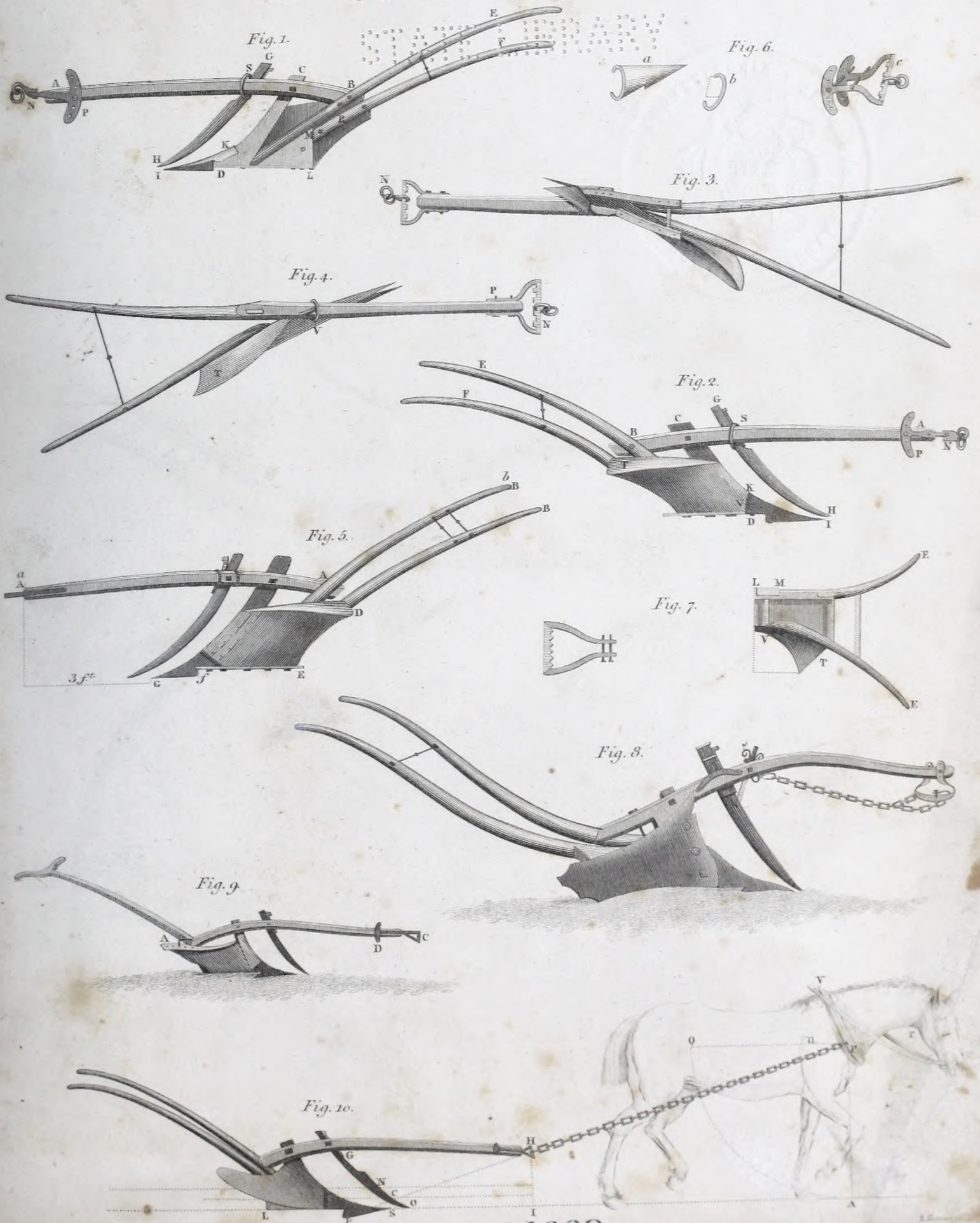
AERONAUTICS

Fig. 3.





AGRICULTURE.

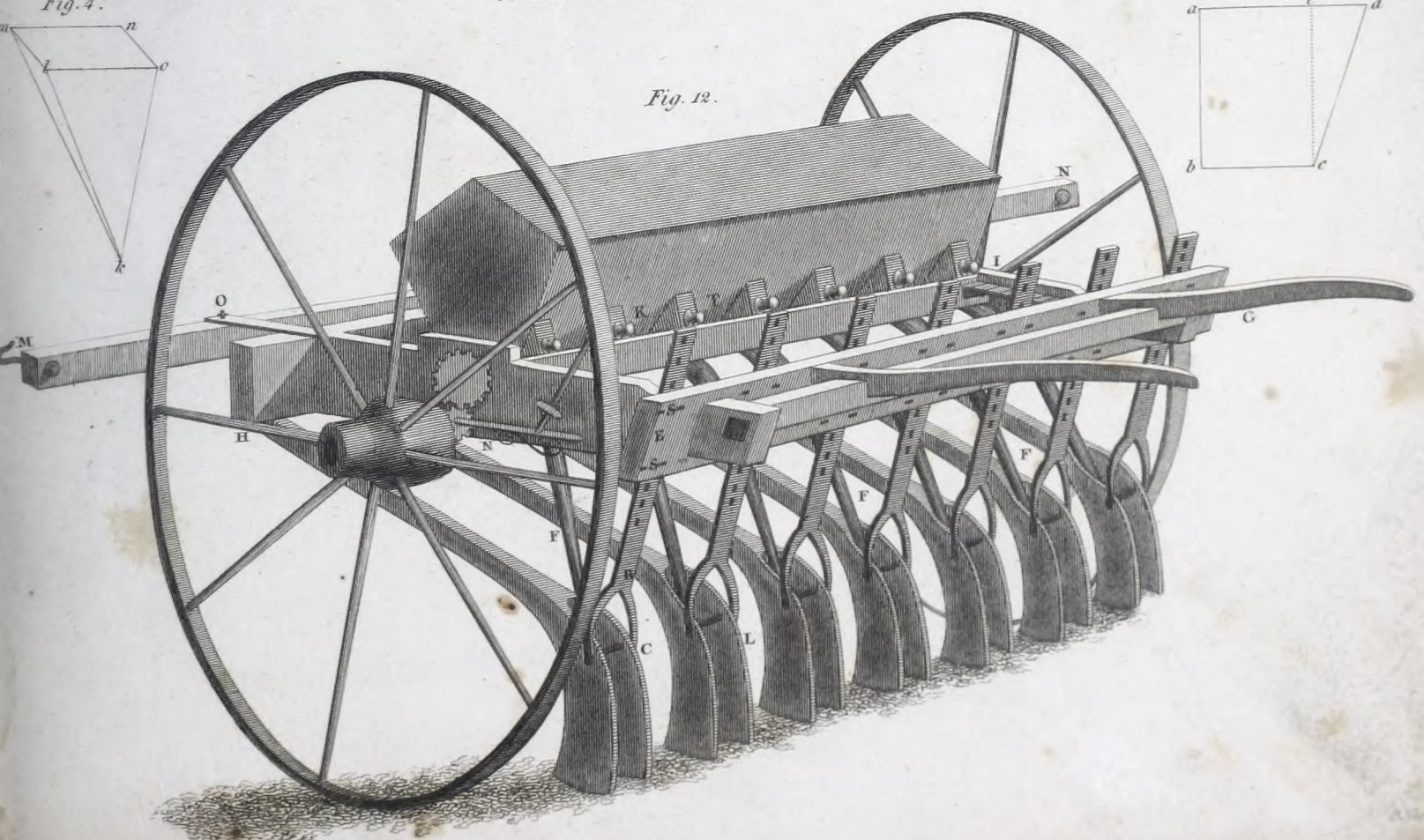
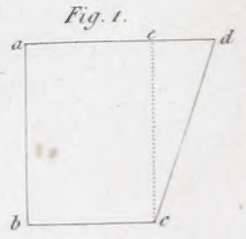
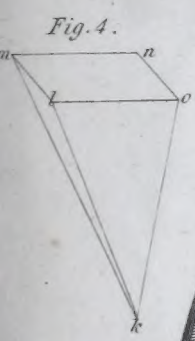
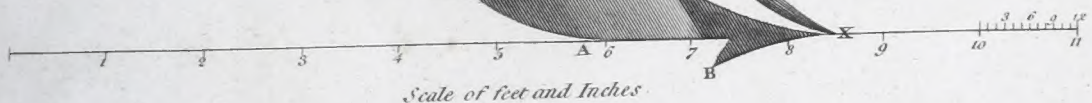
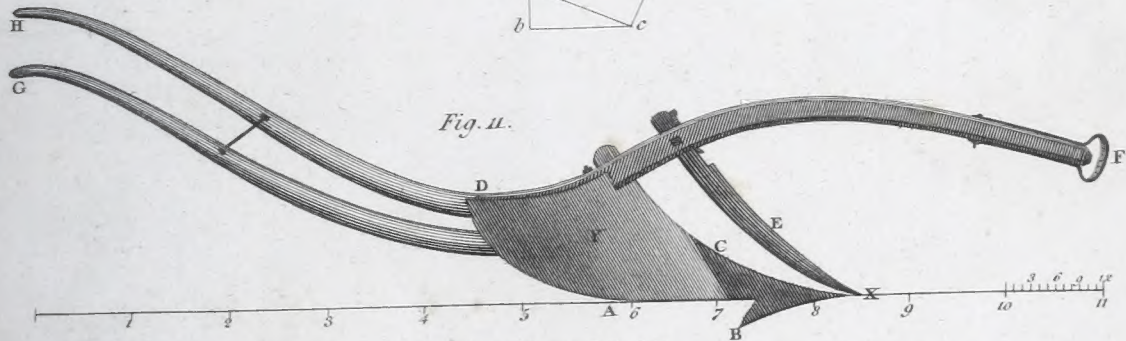
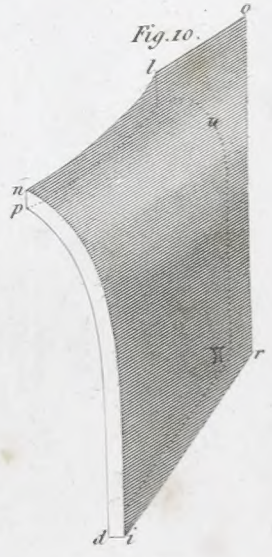
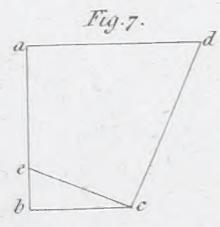
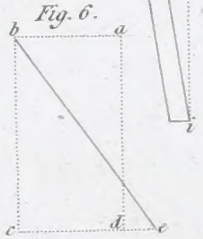
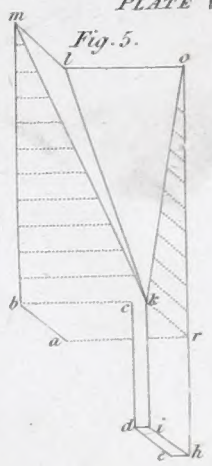
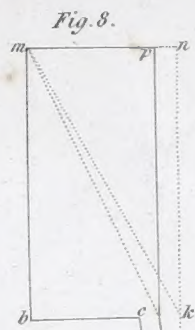
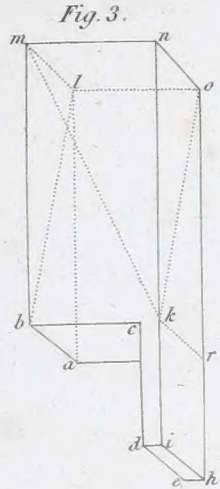
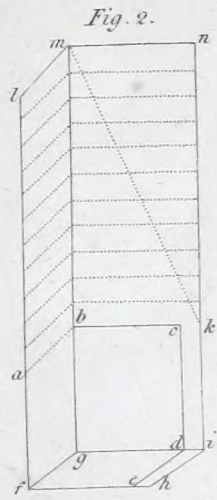
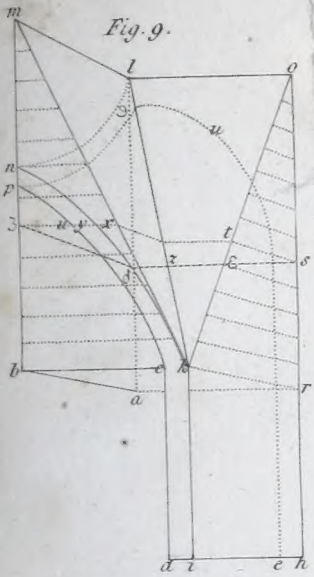


ANNA LYBONEN  
WHEEL STATE



AGRICULTURE.

PLATE VI.



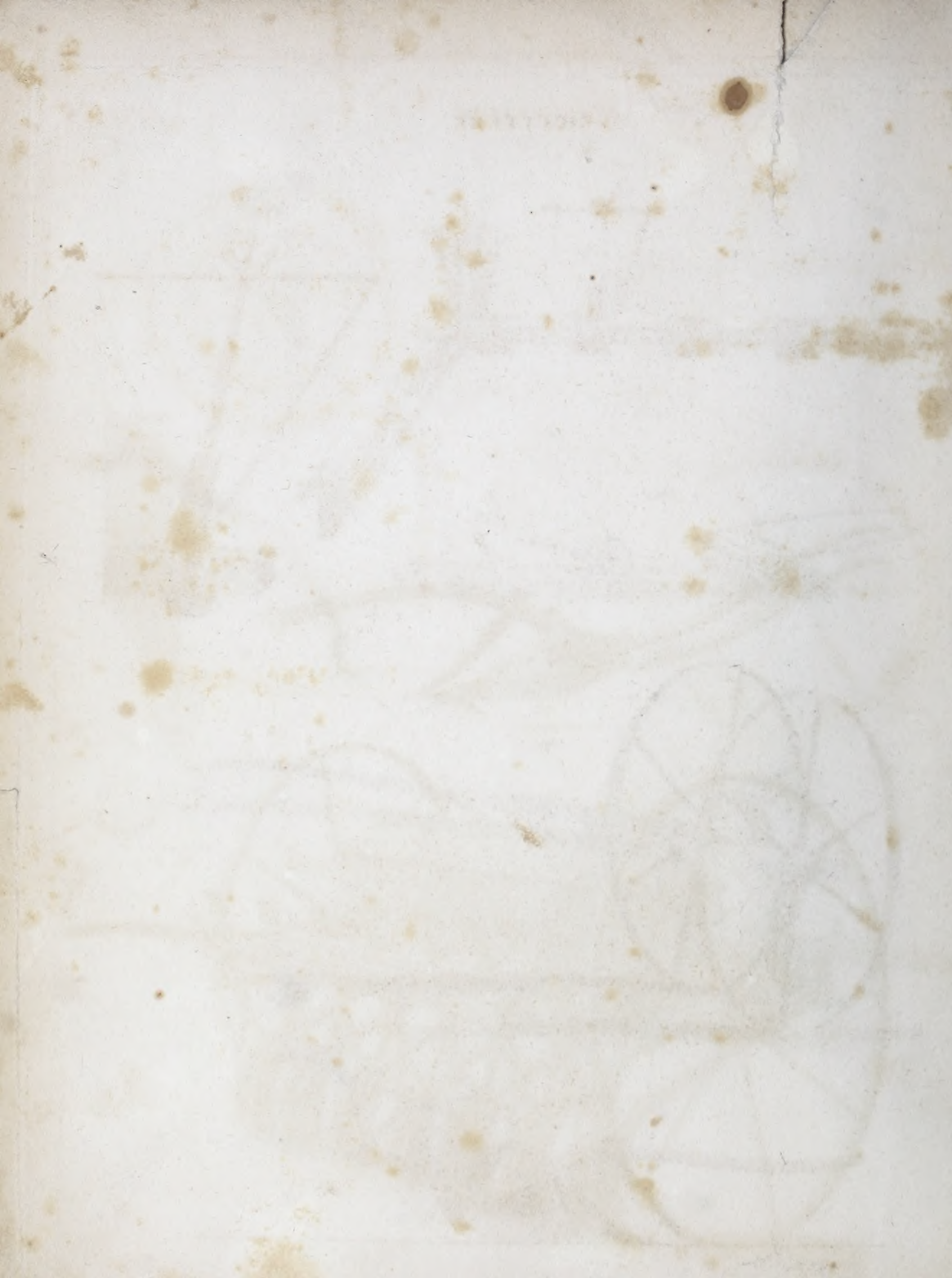




Fig. 1.

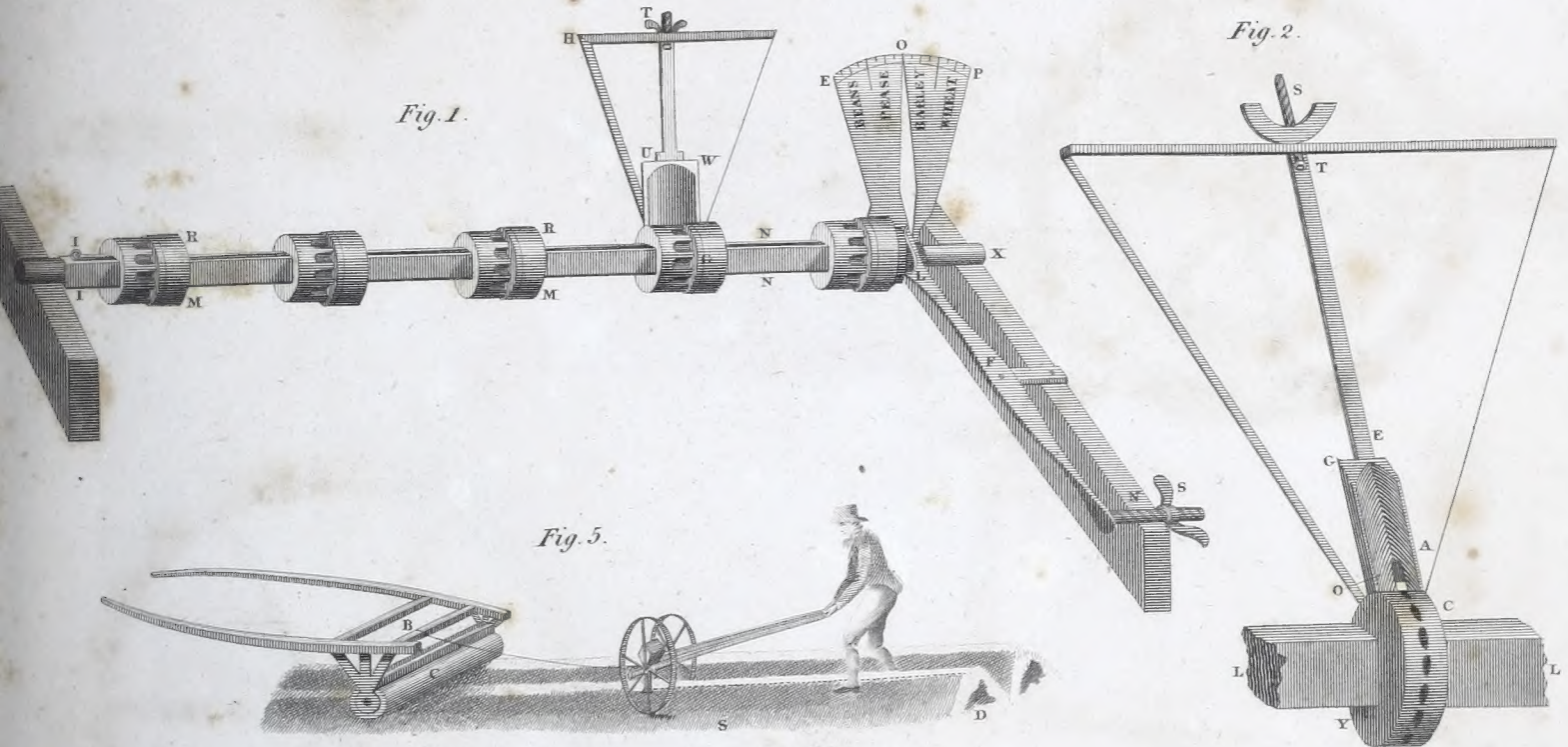


Fig. 2.

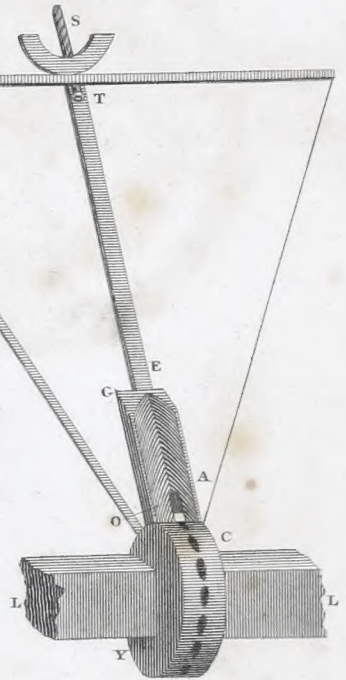


Fig. 5.

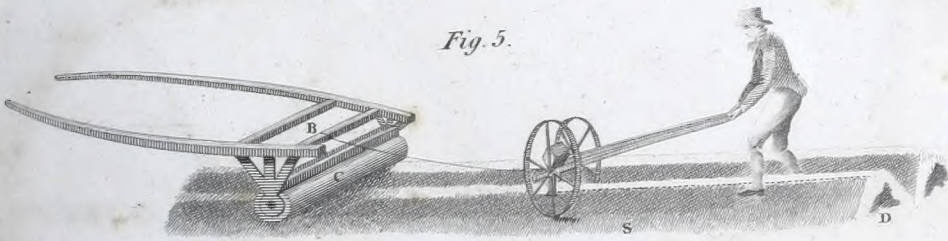


Fig. 3.

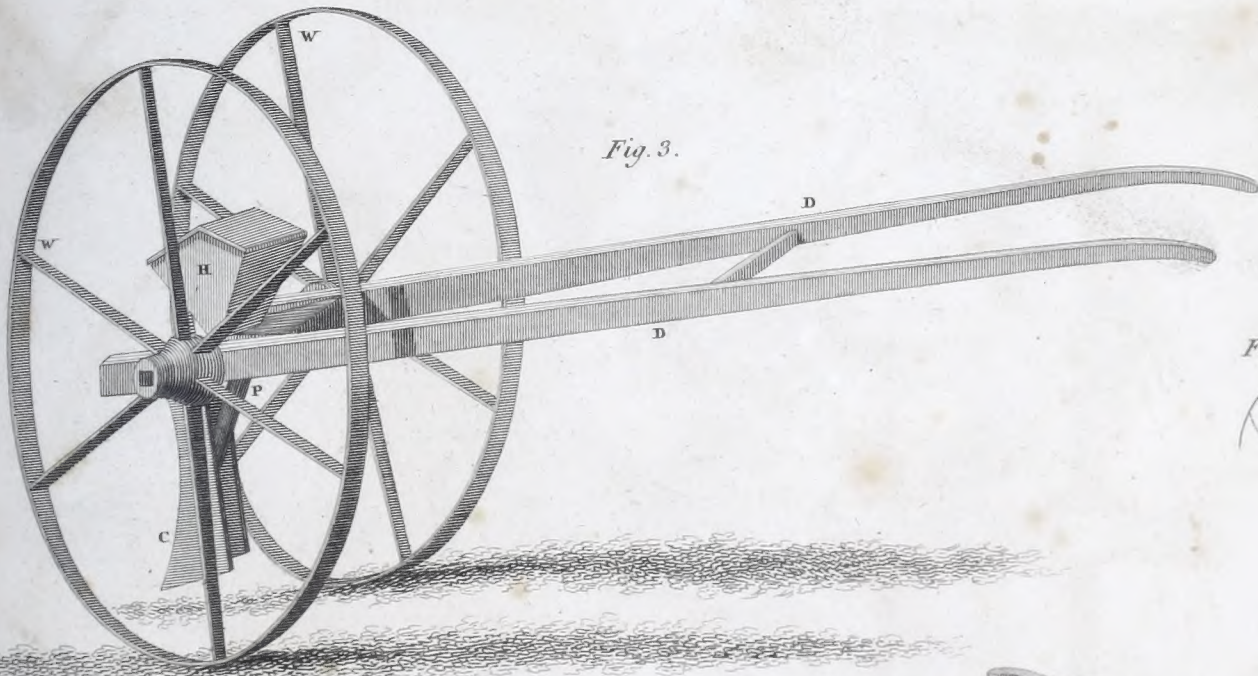
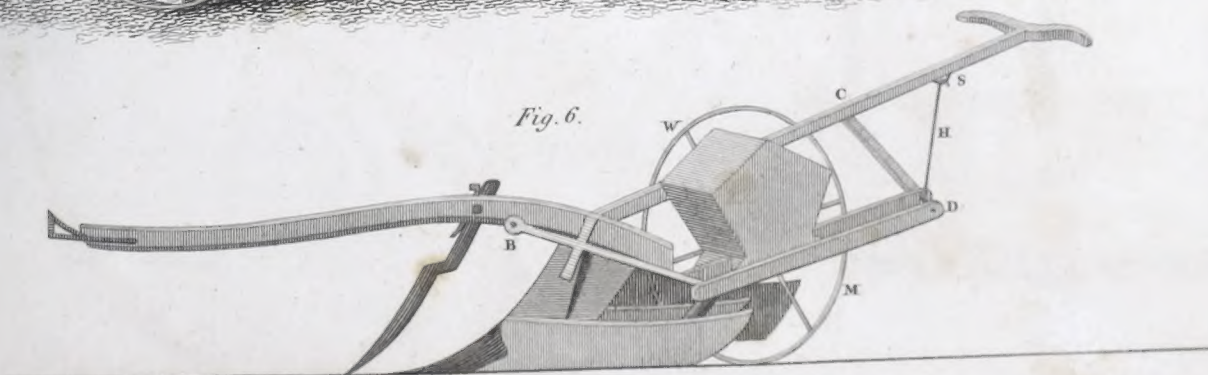


Fig. 4.

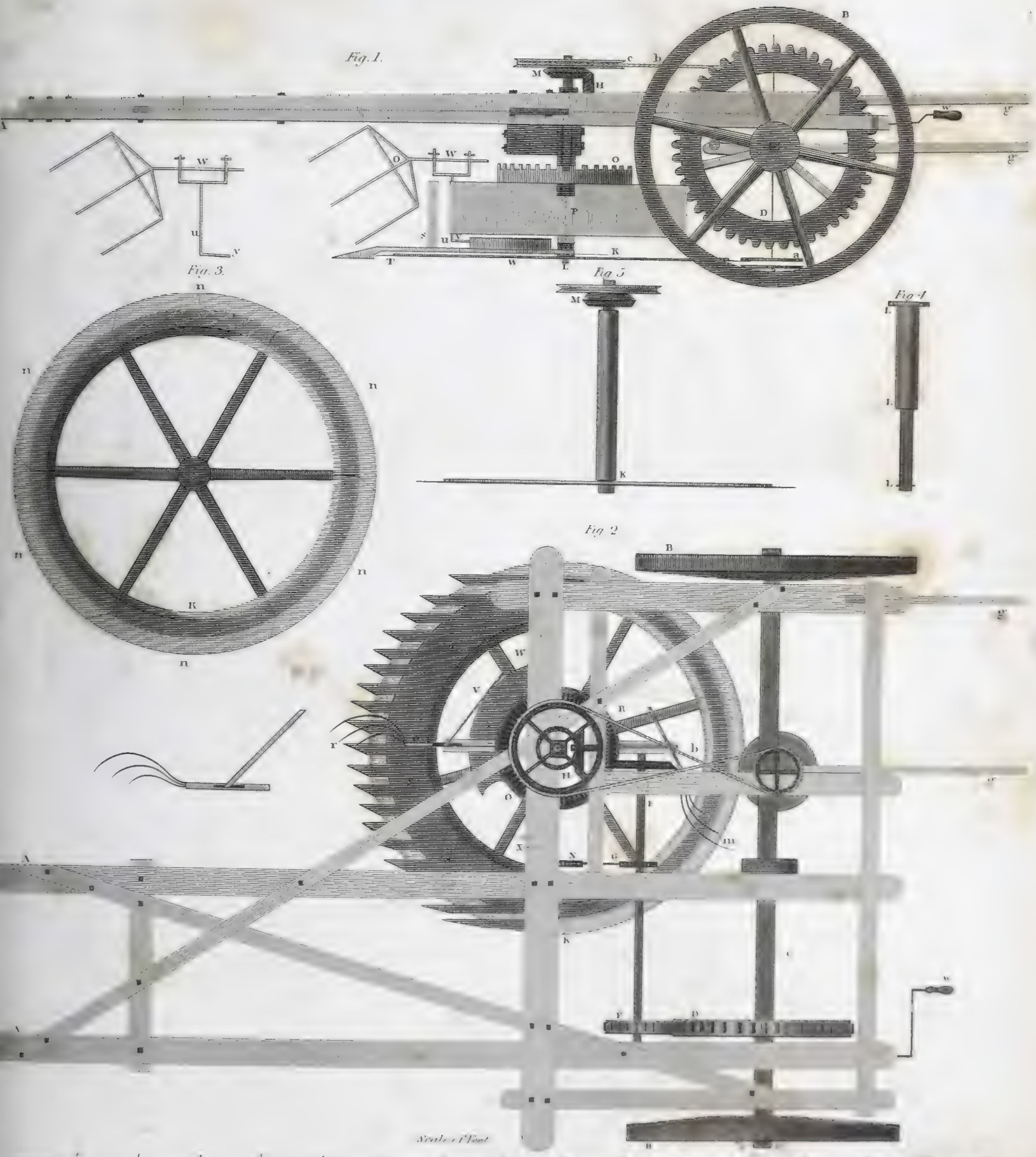


Fig. 6.





REAPING MACHINE





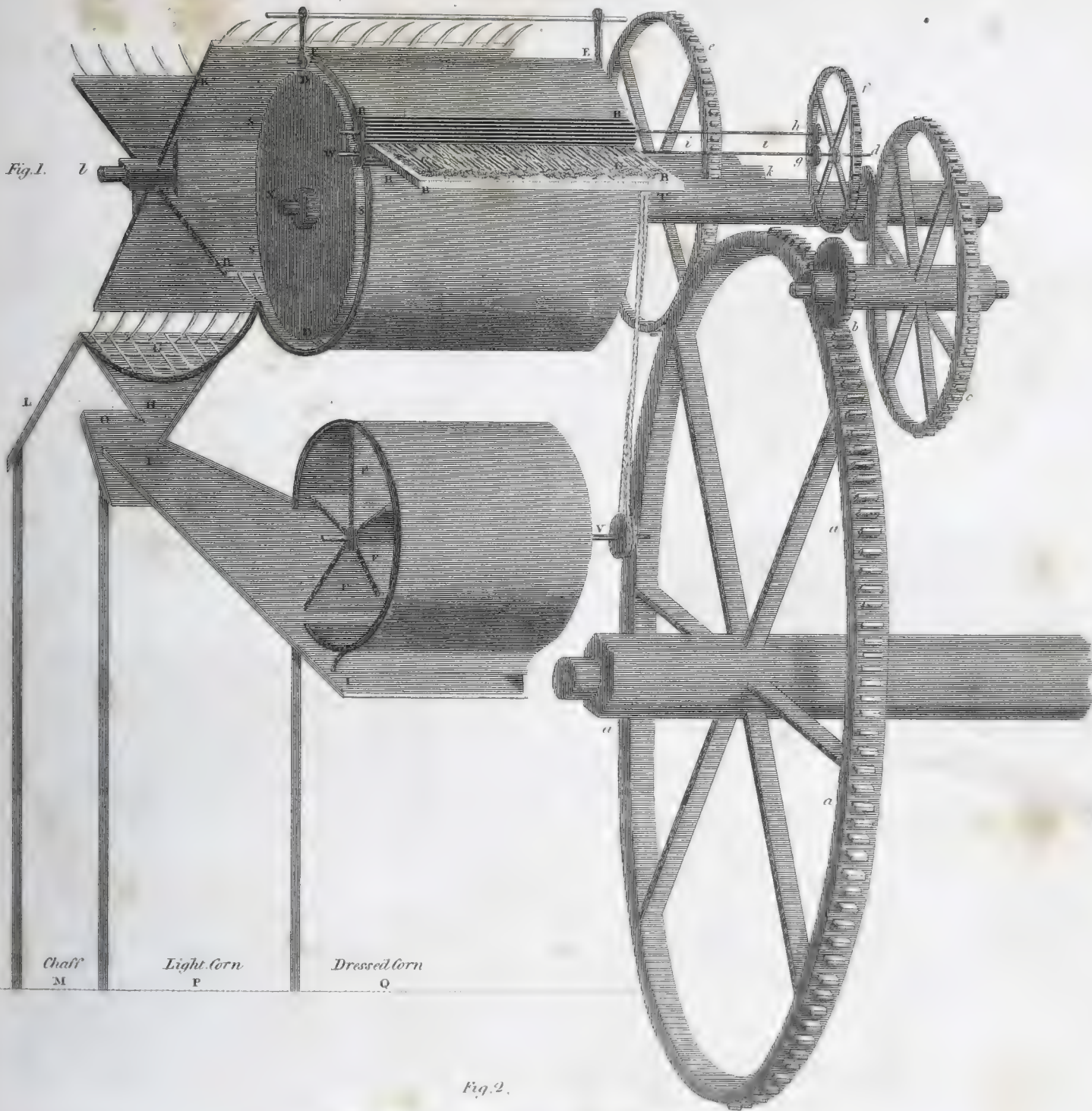
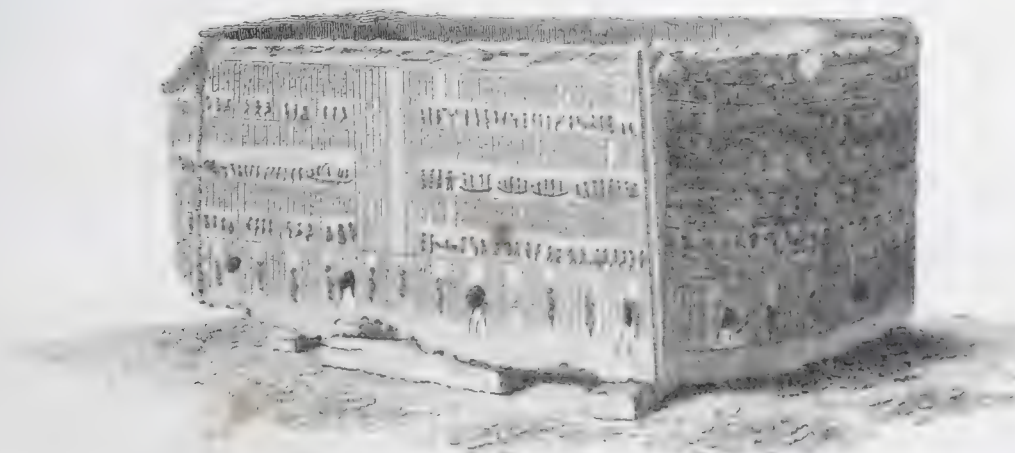


Fig. 2.

TOMB OF ALEXANDER THE GREAT





FENCES.

Fig. 1.

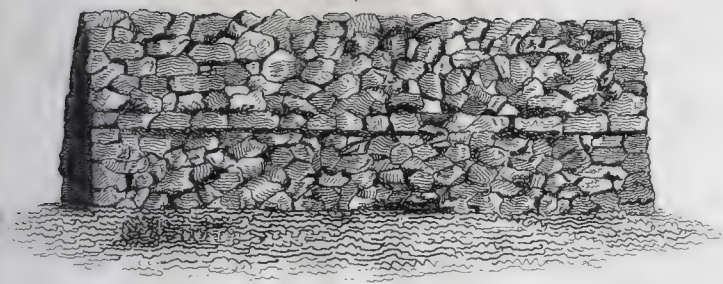


Fig. 2.

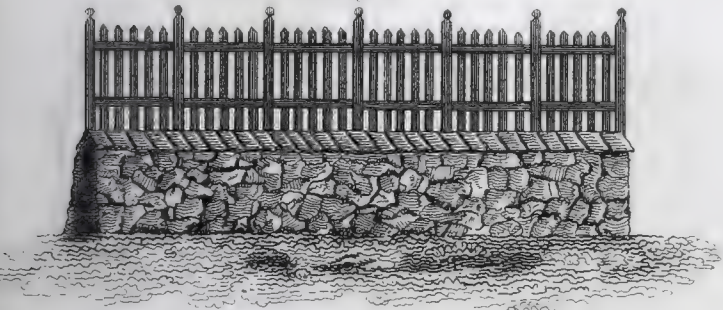


Fig. 3.

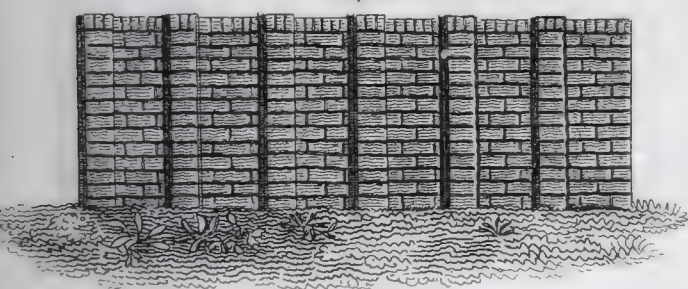


Fig. 4.

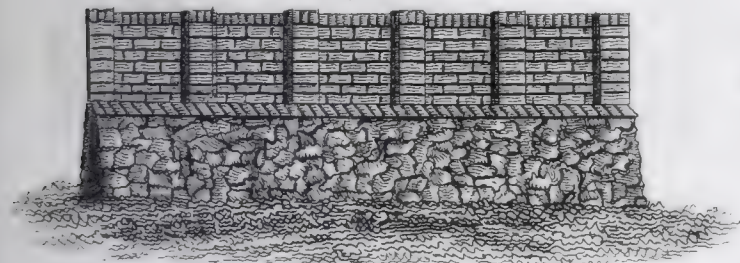


Fig. 5.

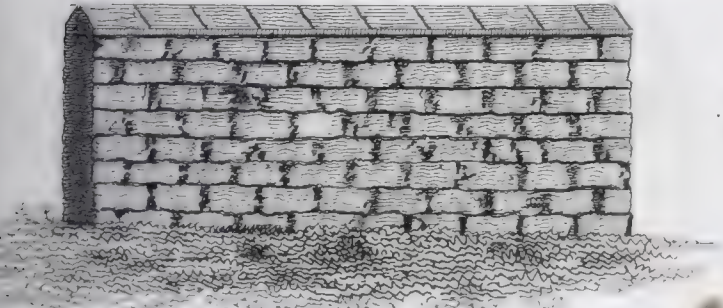


Fig. 6.

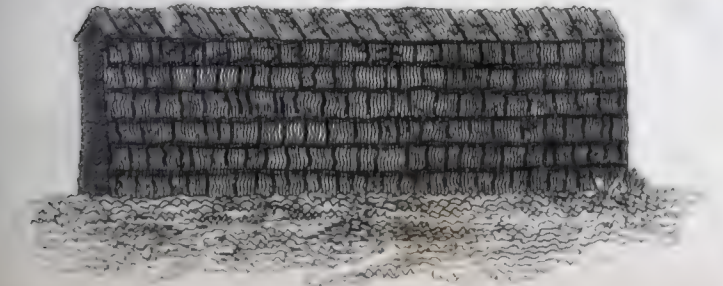


Fig. 7.

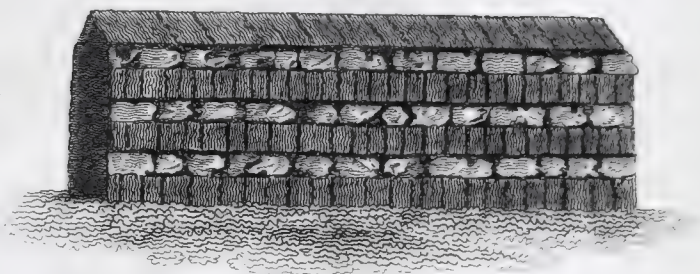


Fig. 8.

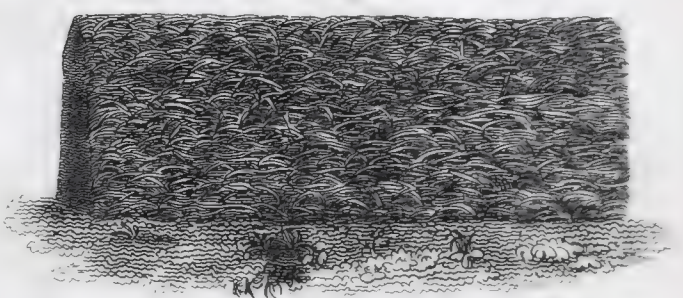


Fig. 9.



Fig. 10.



Fig. 11.



Fig. 12.







Fig 1.



Fig 2.



Fig 3.



Fig 4.

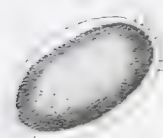


Fig 5.



Fig 7.

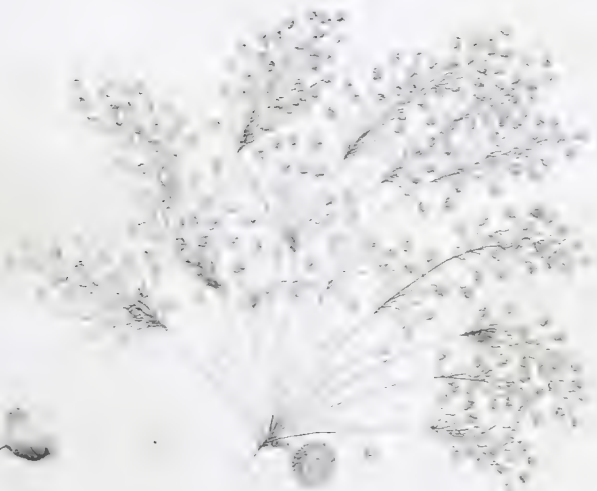


Fig 6.

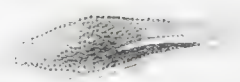


Fig 9.



Fig 8.



Fig 11.

Fig 13.

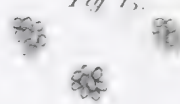


Fig 10.



Fig 12.



Fig 15.



Fig 14.

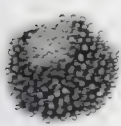


Fig 16.



Fig 17.



Fig 18.





Fig 1.



Fig 2.



Fig 3.



Fig 4.



Fig 5.

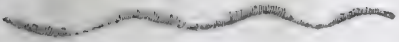


Fig 6.



Fig 7.



Fig 9.



Fig 10.



Fig 8.

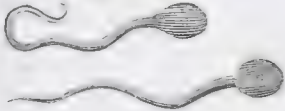


Fig 11.



Fig 12.

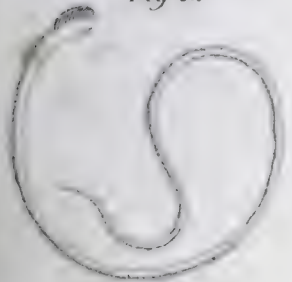


Fig 13.

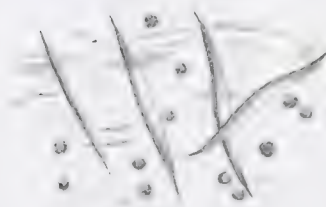


Fig 15.



Fig 16.

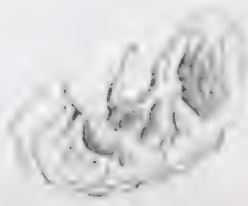


Fig 14.





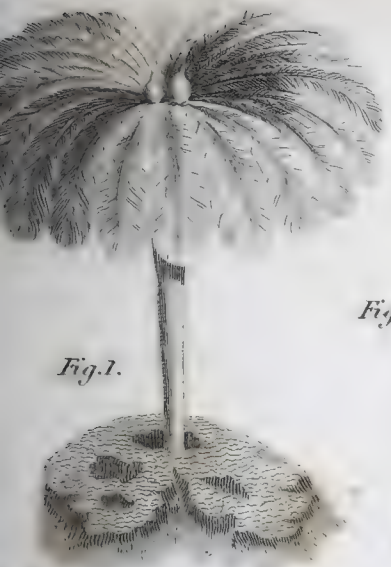


Fig. 1.

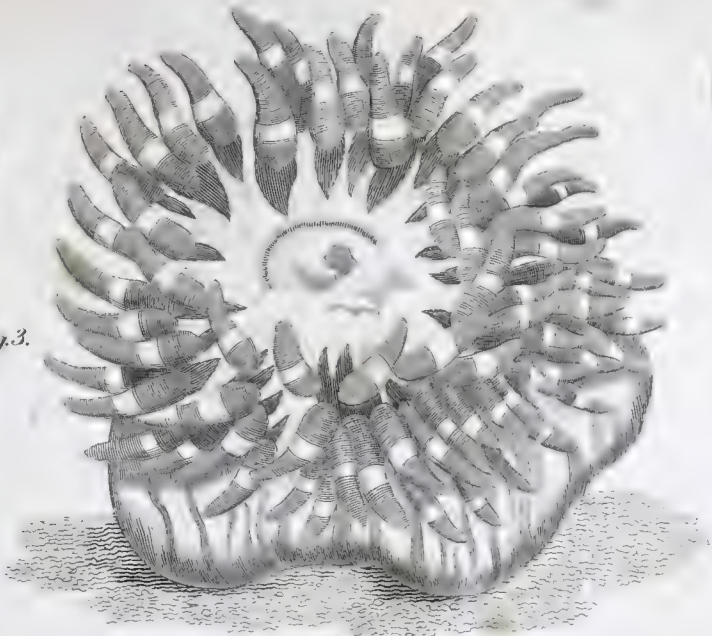


Fig. 3.

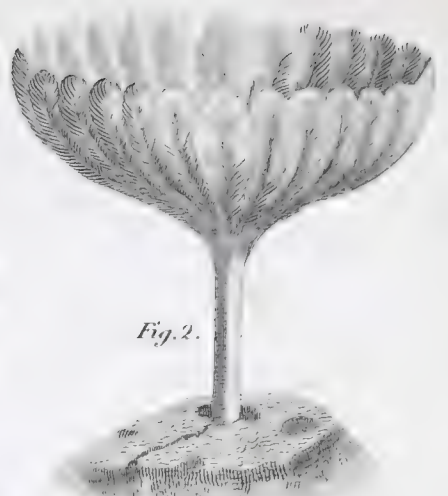


Fig. 2.

Fig. 4.



Fig. 5.



Fig. 10.

Fig. 7.



Fig. 6.



Fig. 8.

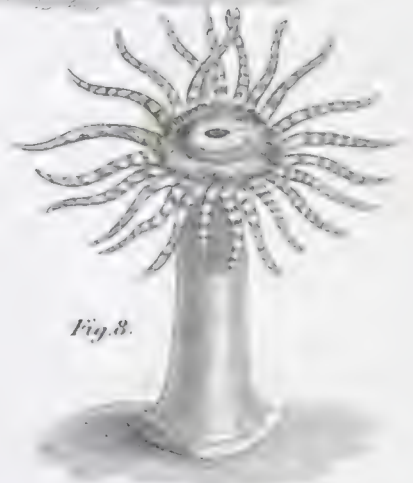
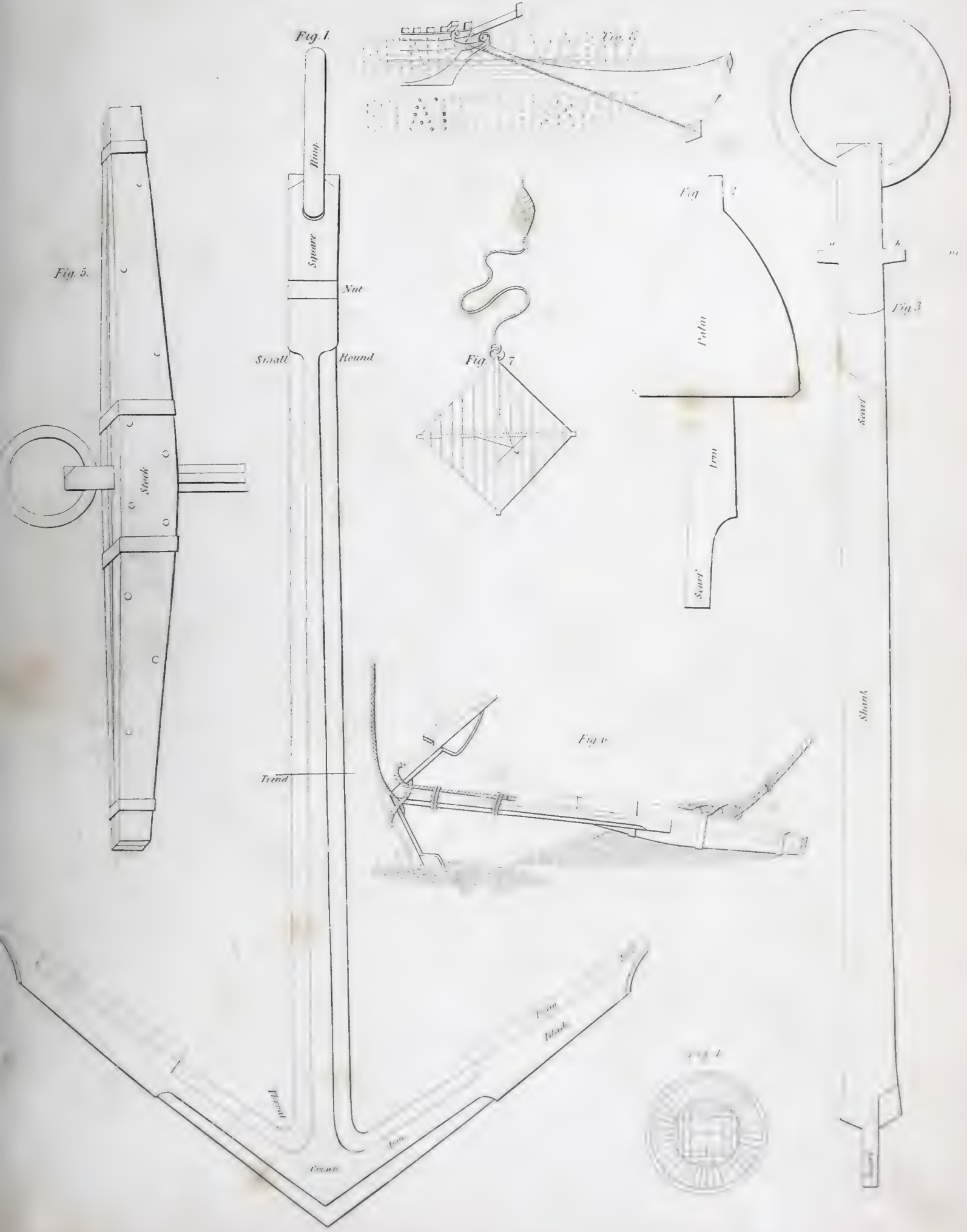


Fig. 9.





ANCHOR.



ALPHABETICAL INDEX  
OF THE



Fig 1.



Fig 2.

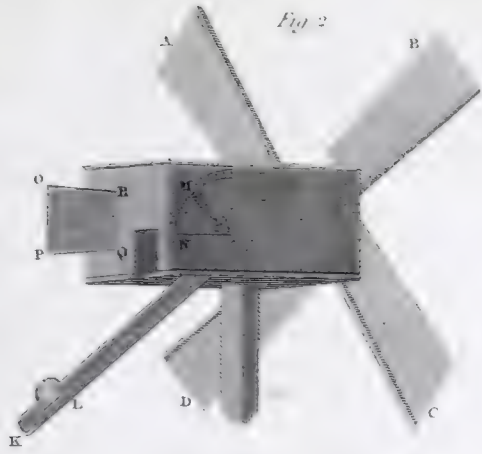


Fig 3.

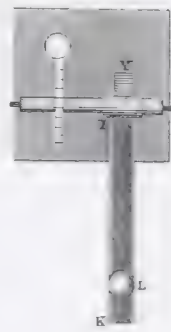


Fig 4.

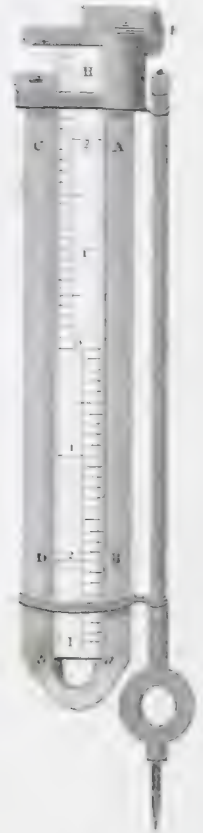


Fig 5.

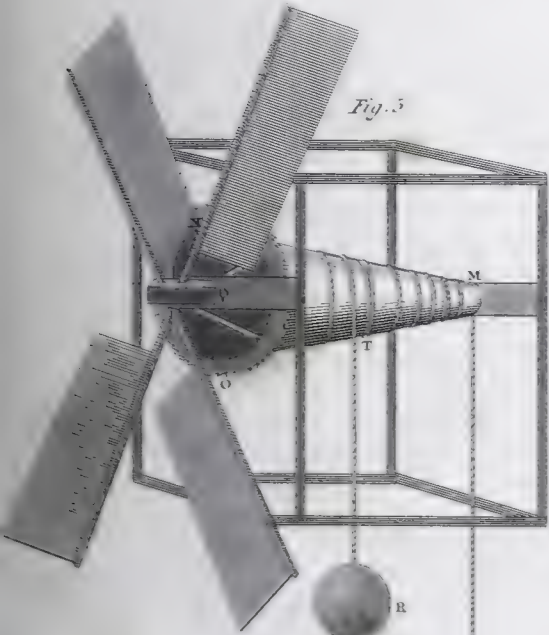


Fig 3.

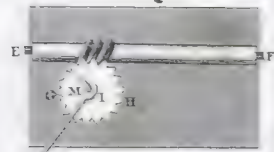


Fig 6.

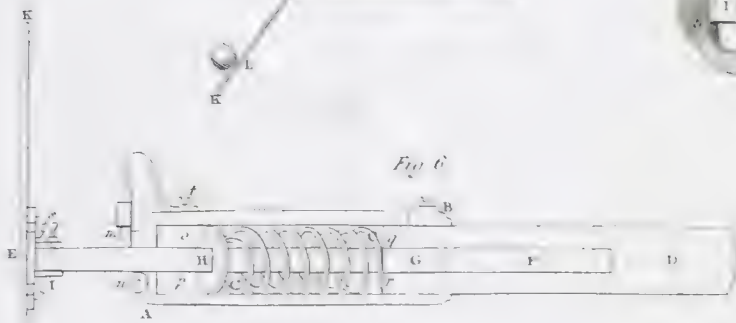


Fig 7.



Fig 8.



Fig 8.



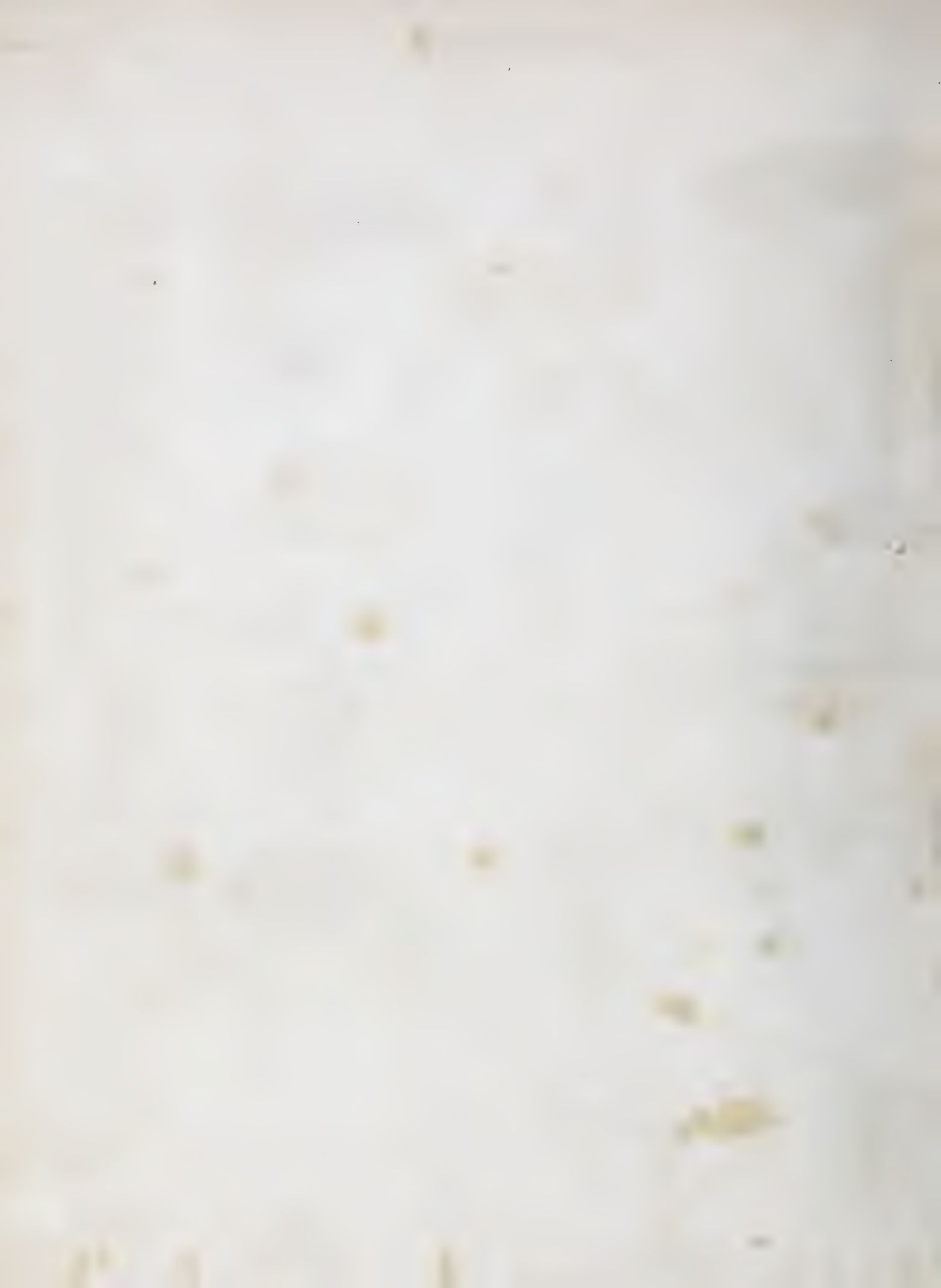


Fig. 15.

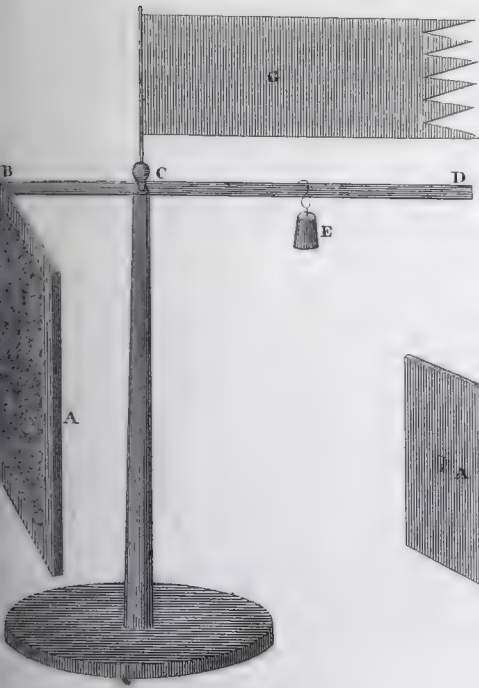


Fig. 11.

Fig. 12.

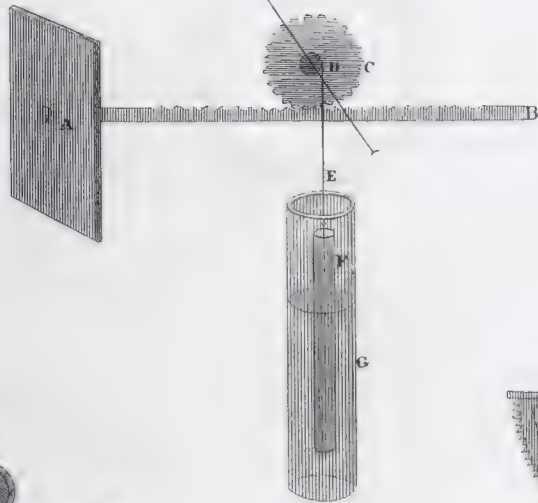


Fig. 11

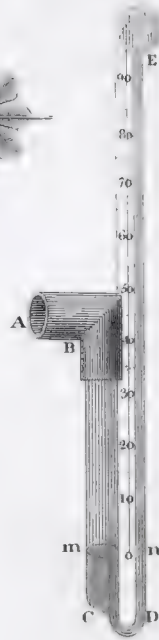


Fig. 16

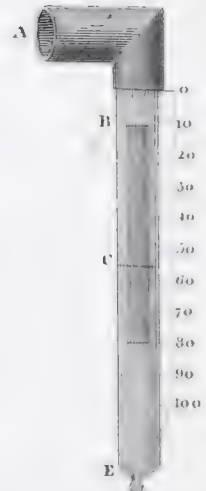


Fig. 6.



Fig. 7.

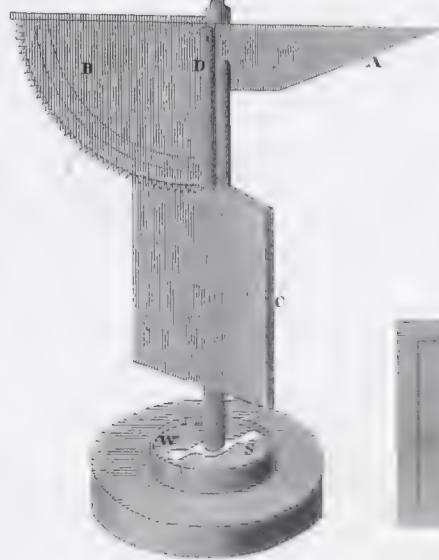


Fig. 8



Fig. 1.

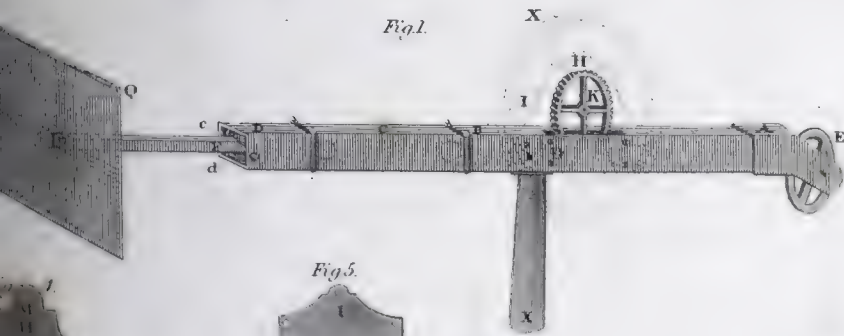


Fig. 5.



G

Fig. 2.

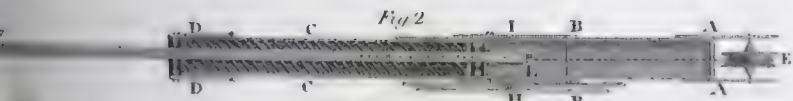


Fig. 9

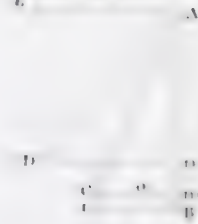
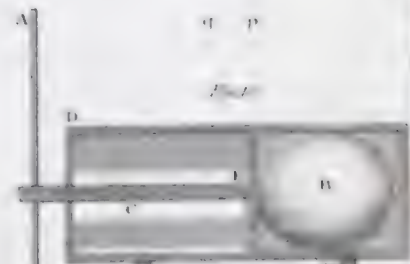
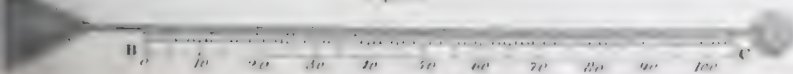


Fig. 3.



Fig. 13





A Table explaining the CHARACTERS by which the elementary MUSICAL INTERVALS are expressed, in our several Articles APOTOME, COMMA, &c. showing their values in four different Modes of Notation for the purpose of facilitating MUSICAL CALCULATIONS in general.

Character	Names of Intervals &c	Ratios or Fractions	Indices of the Powers 2, 3, & 5.	Reciprocals of the common 11 place Logarithms	Side Notation by Σ, f & m
m	Minute	$\frac{2922,977}{2923,003}$ (49 places)	-161 84 12	38.5312	m
f	Super Fraction	$\frac{450283,905}{450359,022}$ (18 places)	-54 37 -2	733.1990	f
d	Medius Fraction	$\frac{50,000,000}{50,034,545}$ (17 places)	16 -35 17	2739.1085	Σ - 3f + m
F	Greater Fraction	$\frac{4,946,832}{4,951,708}$ (23 places)	-92 39 13	4206.1065	Σ - f + m
Σ	Schisma	$\frac{32,768}{32,805}$	15 - 8 - 1	4901.0713	Σ
r	Minor Residual	$\frac{10,400,353,203}{10,485,700,000}$	-24 21 - 1	10535.6417	2 Σ + f
λ	Medius Residual	$\frac{1,594,323}{1,600,000}$	- 9 13 - 5	15436.7130	3 Σ + f
fe	Semi-Comma Major of Rameau	$\frac{15,552}{15,625}$	6 5 - 6	20337.7843	4 Σ + f
fo	Semi-Comma Maxime of Litta	$\frac{2,097,452}{2,109,375}$	21 - 3 - 7	25238.8557	5 Σ + f
R	Greater Residual	$\frac{16,677,181}{16,777,216}$ (7 places)	-33 31 - 9	25972.3517	5 Σ + 2f
R	Major Residual	$\frac{390,625}{393,216}$	-17 - 1 8	28711.4632	6 Σ - f + m
€	Minor Comma	$\frac{2,025}{2,048}$	-11 4 2	49049.2175	10 Σ + m
Q	Prisma	$\frac{36,472,990}{36,893,488}$ (40 places)	-65 41	49782.7165	10 Σ + f + m
c	Major Comma	$\frac{80}{81}$	4 - 4 1	53950.3189	11 Σ + m
d	Diaschisma and least Sum of 4 <sup>th</sup> & 5 <sup>th</sup> Temperaments	$\frac{524,288}{531,441}$	19 - 12	58851.3902	12 Σ + m
D	Dieze Minime	$\frac{19,683}{20,000}$	-5 9 - 4	69387.0318	14 Σ + f + m
π	Hyperoche	$\frac{3,072}{3,125}$	10 1 5	74288.1032	15 Σ + f + m
ε	Enharmonic Diesis	$\frac{125}{128}$	-7 3	102999.5664	21 Σ + 2m
f	Semitone Subminimus	$\frac{243}{250}$	-1 5 - 3	123337.3507	25 Σ + f + 2m
f	Chromatic Diesis	$\frac{16,384}{16,875}$	14 - 3 - 4	128238.4221	26 Σ + f + 2m
f	Semitone Minimum	$\frac{625}{64}$	-3 - 4 4	136949.8853	32 Σ + 3m
f	Semitone Minor	$\frac{24}{25}$	3 1 - 2	177287.6696	36 Σ + f + 3m
L	Limma	$\frac{243}{250}$	-8 5	226336.9171	40 Σ + f + 4m
S	Semitone Medius	$\frac{128}{135}$	7 - 3 - 1	231237.9885	47 Σ + f + 4m
S	Semitone Major	$\frac{15}{16}$	-4 1 1	250257.2360	57 Σ + f + 5m
P	Apotome	$\frac{2,048}{2,187}$	11 - 7	285188.3073	58 Σ + f + 5m
S	Semitone Maximum	$\frac{25}{27}$	-3 2	334237.5519	68 Σ + f + 6m
4ε	least Sum of III & 6 <sup>th</sup> Temperaments	$\frac{244,110,625}{268,435,456}$	-28 12	411998.2656	64 Σ + 6m
t	Tone Minor	$\frac{40}{41}$	-1 2 - 1	45757.4900	46 Σ + 2f + 1m
3f	least Sum of 3 <sup>rd</sup> & VI <sup>th</sup> Temperaments	$\frac{244,110,625}{272,097,792}$	-9 - 12 12	470819.0559	96 Σ + 9m
T	Tone Major	$\frac{8}{9}$	3 - 2	511525.2245	104 Σ + 2f + 9m
T	Tone Maximum	$\frac{640}{729}$	7 - 6 1	565475.5433	115 Σ + 2f + 10m
3 <sup>rd</sup>	Minor Third	$\frac{5}{6}$	-1 - 1 1	791812.4605	104 Σ + 3f + 8m
III <sup>rd</sup>	Major Third	$\frac{4}{5}$	2 - 1	969100.1301	197 Σ + 1f + 17m
4 <sup>th</sup>	Fourth	$\frac{3}{4}$	-2 1	1249317.3661	354 Σ + 5f + 22m
V <sup>th</sup>	Fifth	$\frac{2}{3}$	1 - 1	1706912.5966	354 Σ + 7f + 31m
6 <sup>th</sup>	Minor Sixth	$\frac{3}{5}$	-3 1	2071194.8200	485 Σ + 4f + 36m
VI <sup>th</sup>	Major Sixth	$\frac{4}{5}$	1 - 1	2218317.4962	451 Σ + 9f + 39m
VIII <sup>th</sup>	Eighth or Octave	$\frac{1}{1}$	-1	3010299.9700	672 Σ + 7f + 50m



ARITHMETICAL CHARACTERS.

Fig. 1.

1	11	12	13	14	15	16	17	18	19	10 of Planudes
1	11	12	13	14	15	16	17	18	19	1. Alsephuti
I	II	III	IV	V	VI	VII	VIII	IX	X	Boethius
1	2	3	4	5	6	7	8	9	10	Sacro Bosco
1	2	3	4	5	6	7	8	9	10	R. Bacon
१	२	३	४	५	६	७	८	९	१०	Modern India
1	2	3	4	5	6	7	8	9	10	Modern Europe

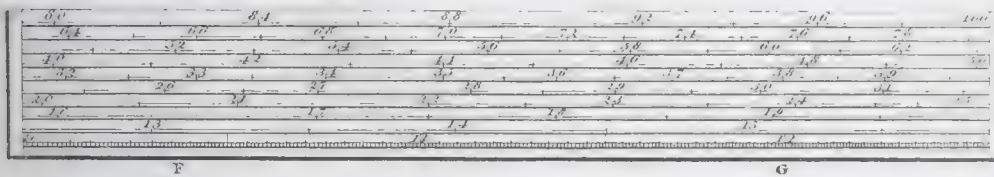
NAPIERS RODS.

Fig. 5. N<sup>o</sup> 1.

1	2	3	4	5	6	7	8	9	0
2	4	8	16	32	64	128	256	512	1024
3	6	12	24	48	96	192	384	768	1536
4	8	16	32	64	128	256	512	1024	2048
5	10	20	40	80	160	320	640	1280	2560
6	12	24	48	96	192	384	768	1536	3072
7	14	28	56	112	224	448	896	1792	3584
8	16	32	64	128	256	512	1024	2048	4096
9	18	36	72	144	288	576	1152	2304	4608

SLIDING RULE.

Fig. 2.

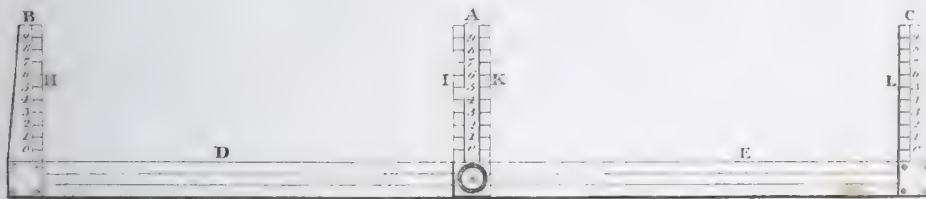


NAPIERS RODS.

Fig. 5. N<sup>o</sup> 2.

1	2	3	4	5
2	4	8	16	32
3	6	12	24	48
4	8	16	32	64
5	10	20	40	80
6	12	24	48	96
7	14	28	56	112
8	16	32	64	128
9	18	36	72	144

Fig. 3.



ARITHMETIC OF SINES.

Fig. 6.

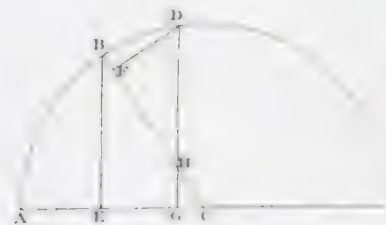


Fig. 4.



ARITHMETIC OF SINES.

Fig. 8.

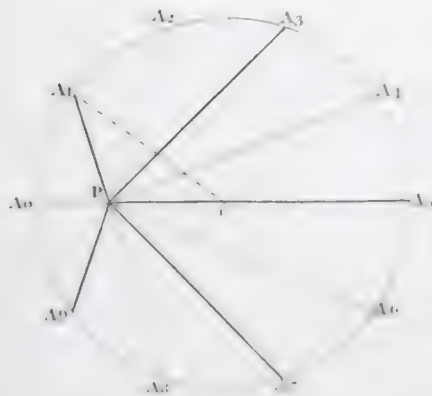


Fig. 7.

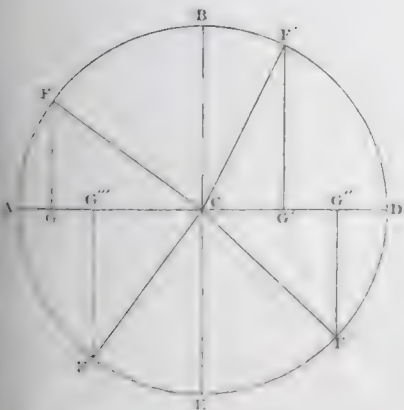
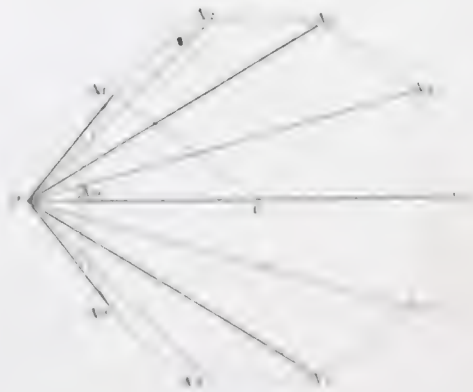


Fig. 9.







# ARITHMETIC.

## PASCAL'S MACHINE.

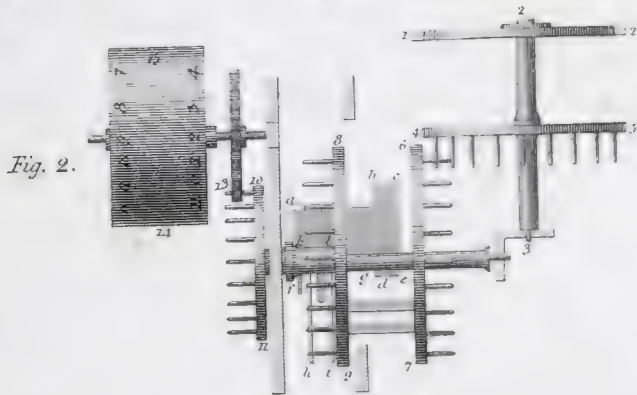
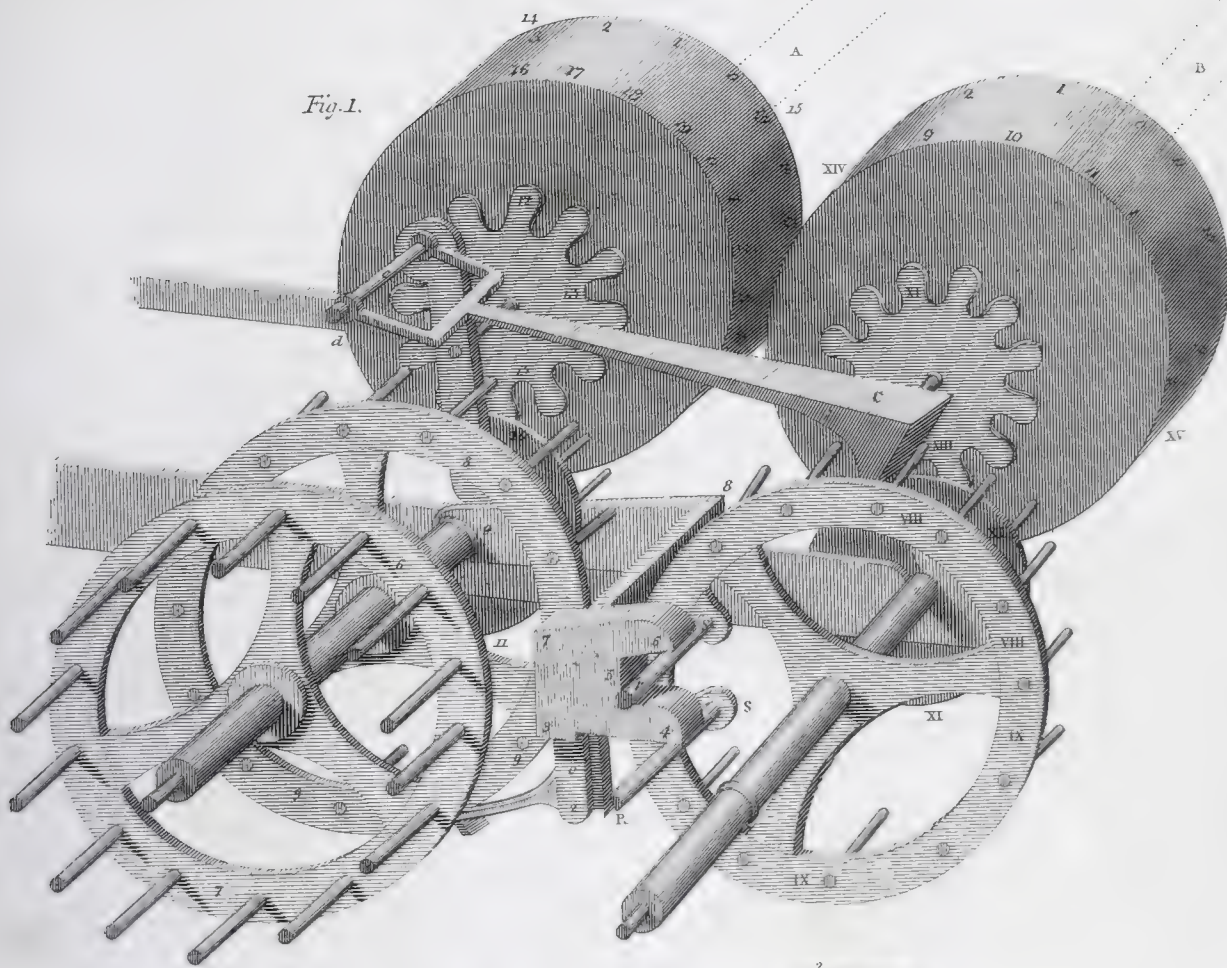




Fig. 1.

Orbit of the Germanian Satellites



Fig. 2.





Fig. 2.

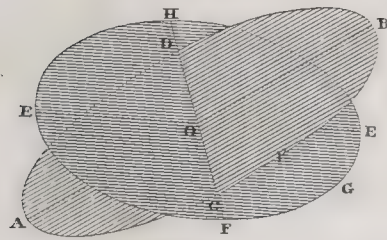


Fig. 3.

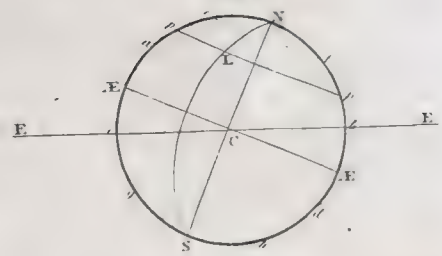


Fig. 1.

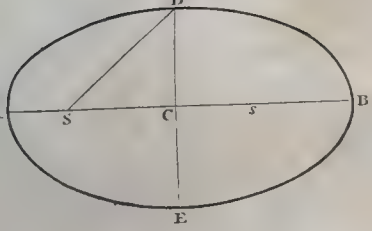


Fig. 8.

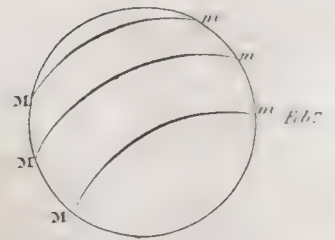


Fig. 5.

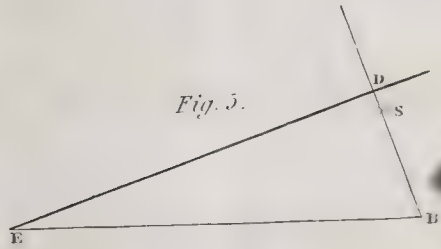


Fig. 4.

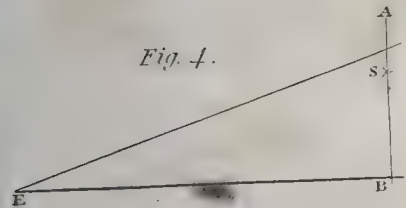


Fig. 7.

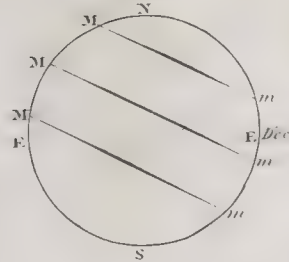


Fig. 9.

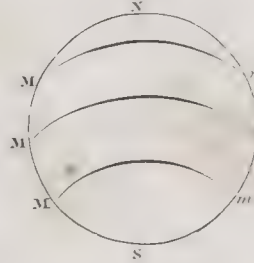


Fig. 10.

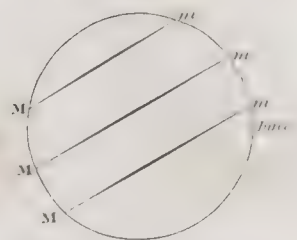


Fig. 12.

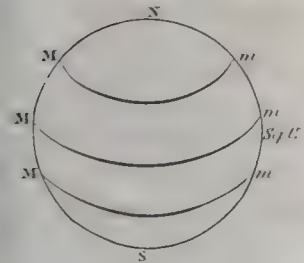


Fig. 11.

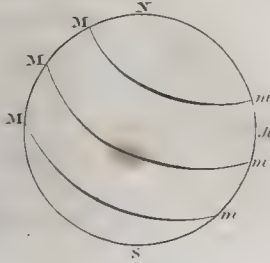


Fig. 6.

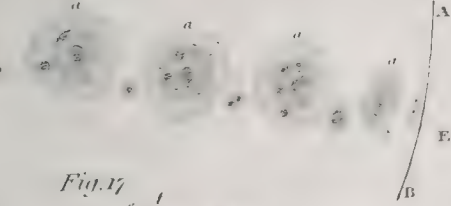


Fig. 13.

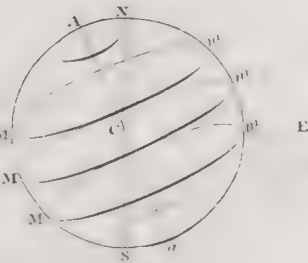


Fig. 14.

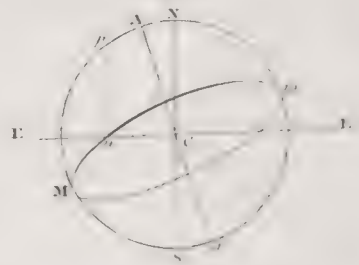


Fig. 16.



Fig. 17.



Fig. 18.



Fig. 19.

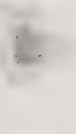


Fig. 20.



Fig. 15.



Fig. 23.



Fig. 24.



Fig. 25.



Fig. 21.



Fig. 22.



Fig. 23.

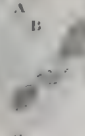


Fig. 26.



Fig. 25.



Fig. 27.



Fig. 20.





Fig. 1.

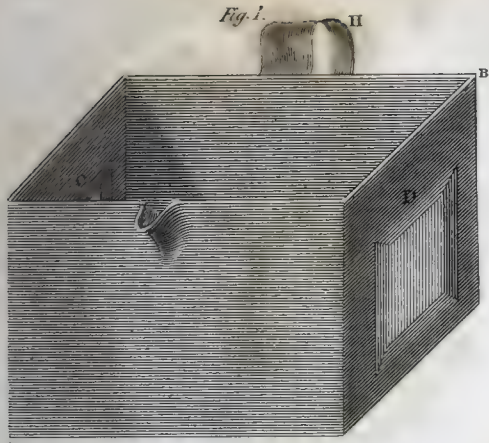


Fig. 2.

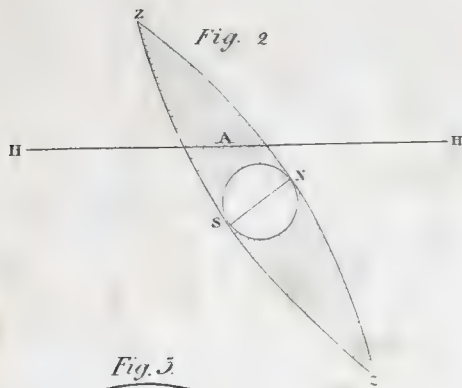


Fig. 3.

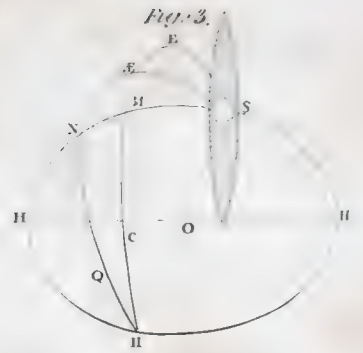


Fig. 5.

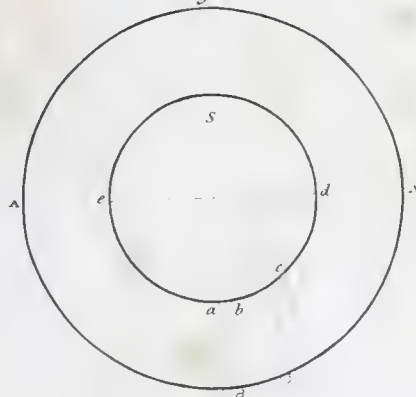


Fig. 7.

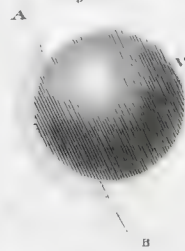


Fig. 8.



Fig. 9.

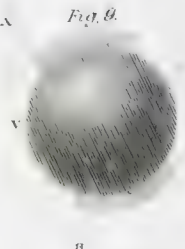


Fig. 10.



Fig. 4.

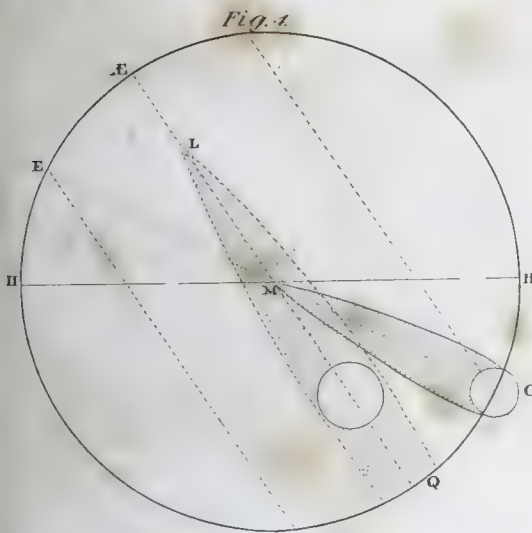


Fig. 11.

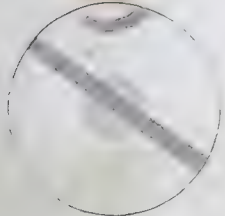


Fig. 12.

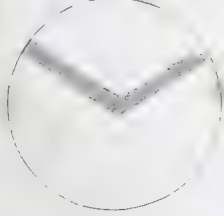


Fig. 13.



Fig. 14.



Fig. 15.



Fig. 16.



Fig. 17.



Fig. 18.



Fig. 19.



Fig. 20.



Fig. 21.



Fig. 22.

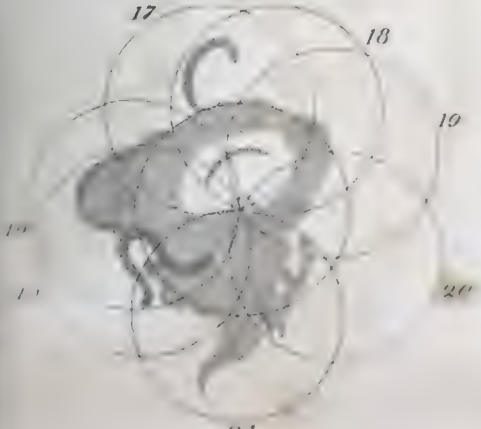


Fig. 23.

Fig. 6.

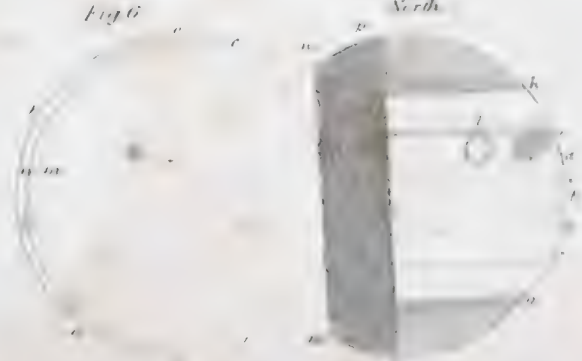


Fig. 24.









Fig. 12.

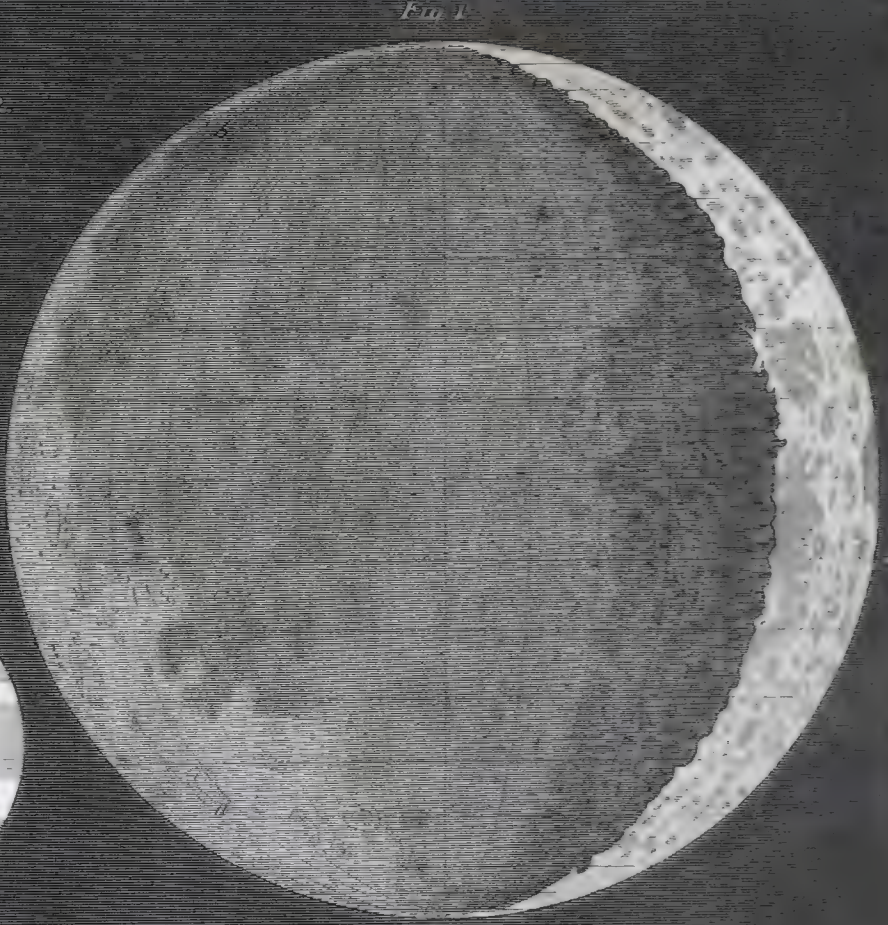


Fig. 1.



Fig. 8.

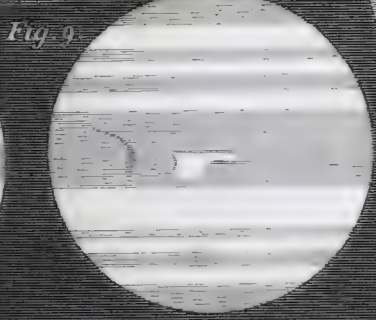


Fig. 9.

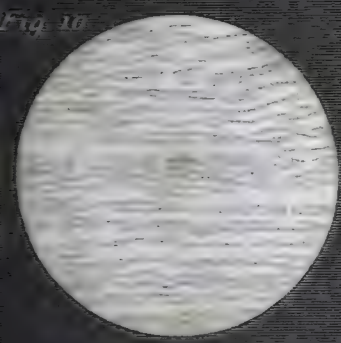


Fig. 10.



Fig. 11.

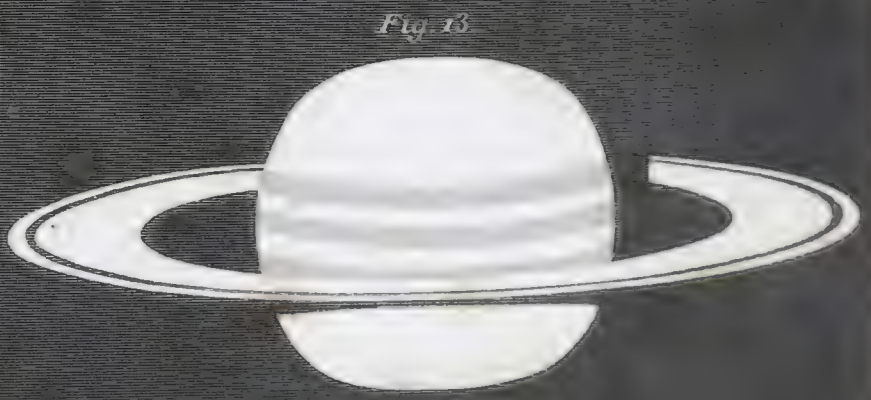


Fig. 13.

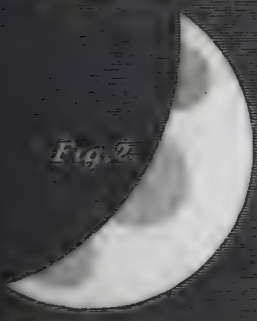


Fig. 2.

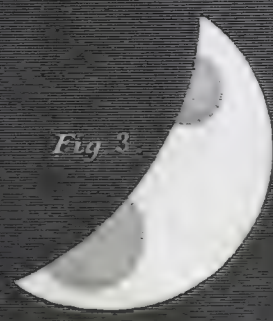


Fig. 3.

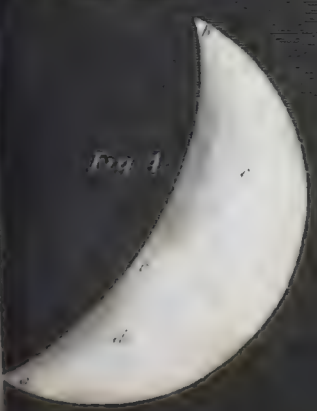


Fig. 4.

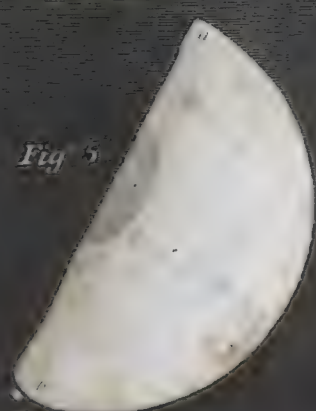


Fig. 5.

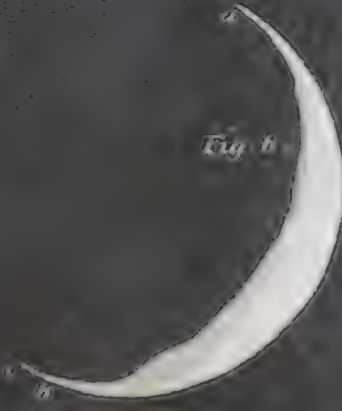


Fig. 6.



Fig. 7.

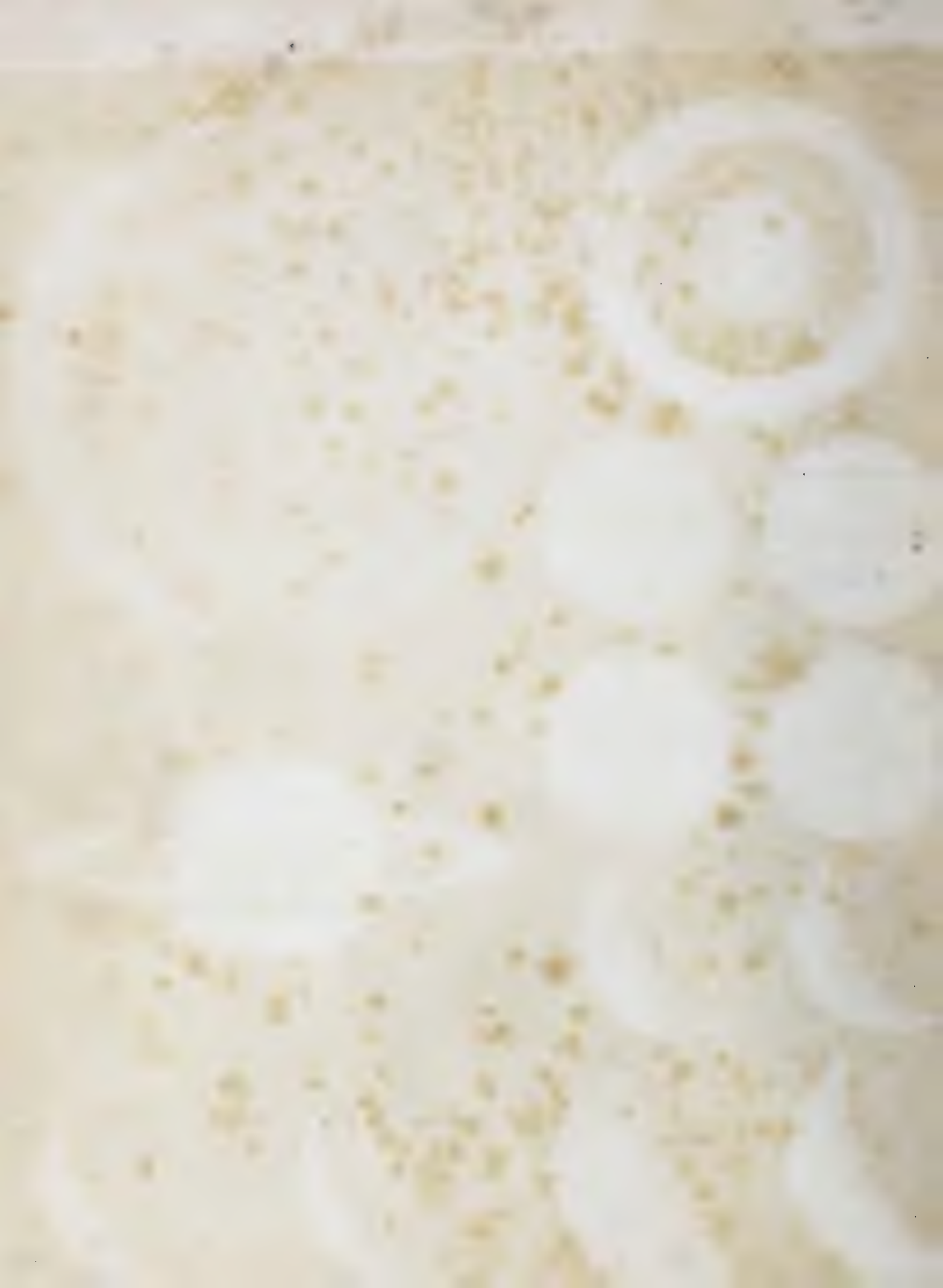


Fig. 1.

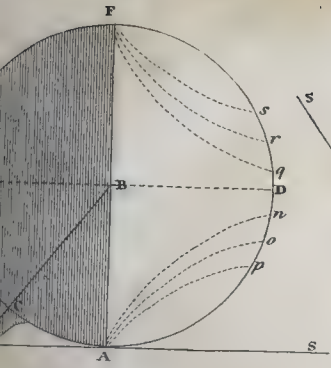


Fig. 2.

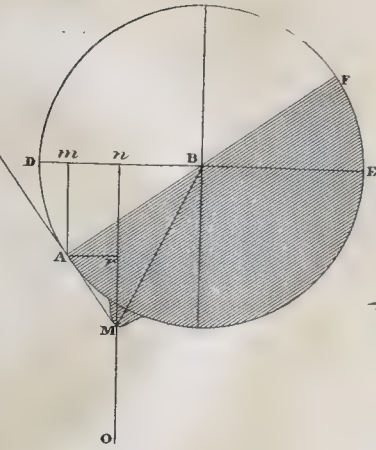


Fig. 4.

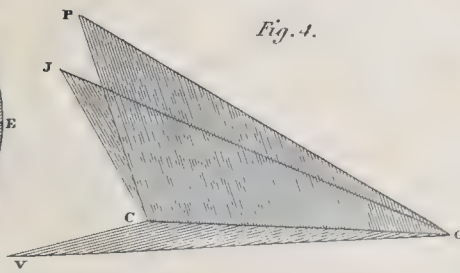


Fig. 6.

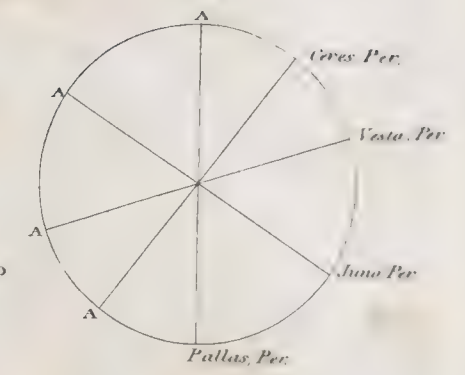


Fig. 3.

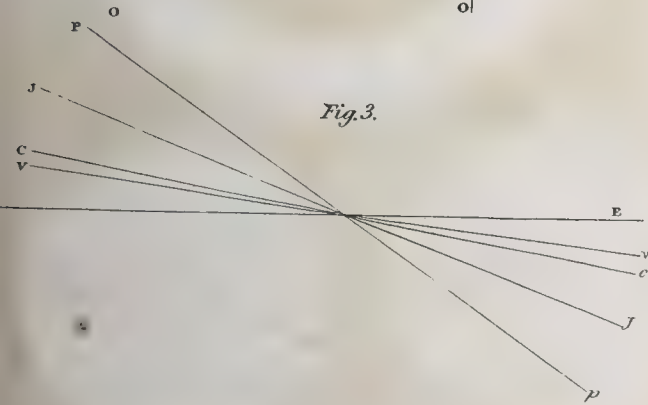


Fig. 5.

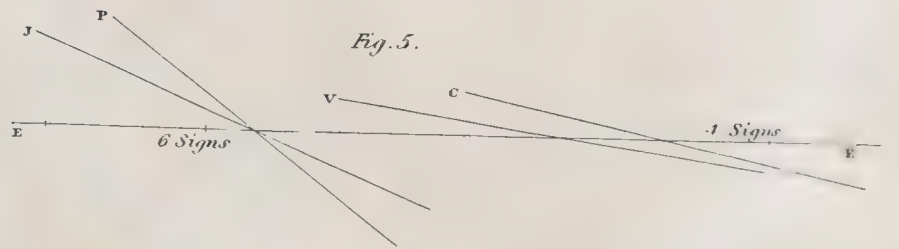


Fig. 7.

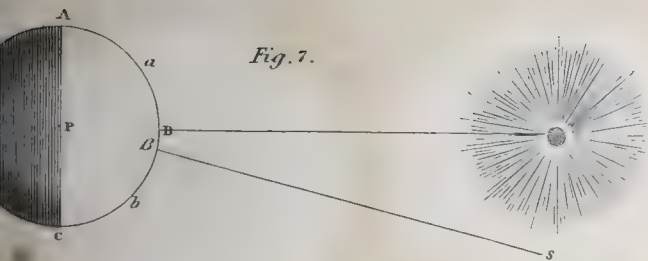


Fig. 8.

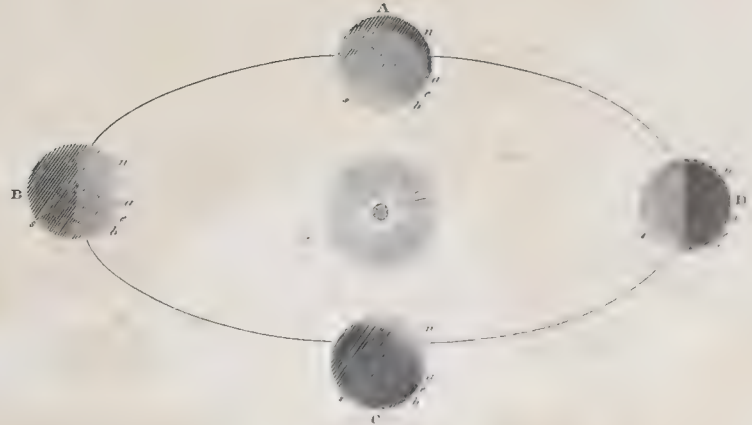


Fig. 9.

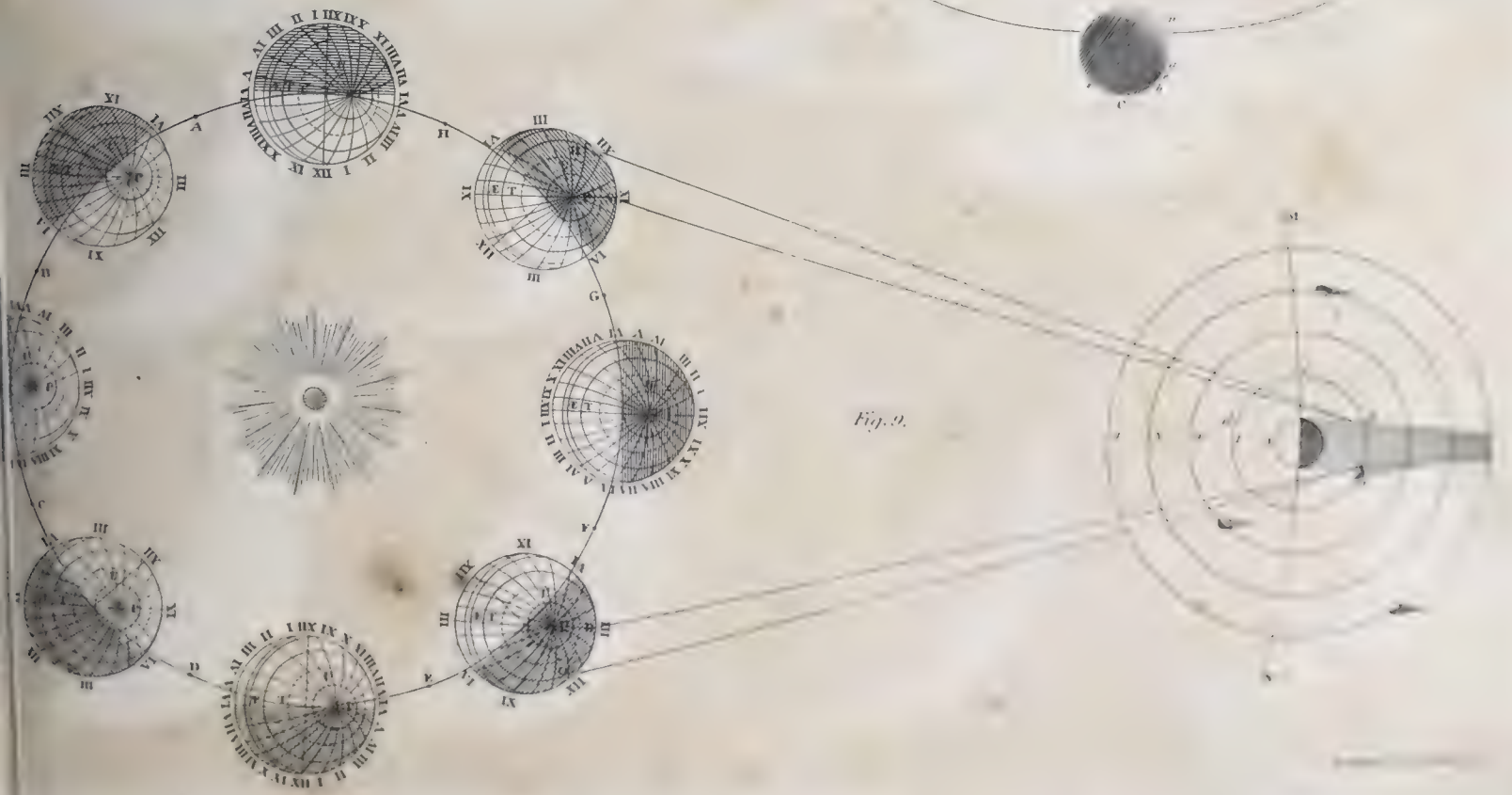




Fig. 1.

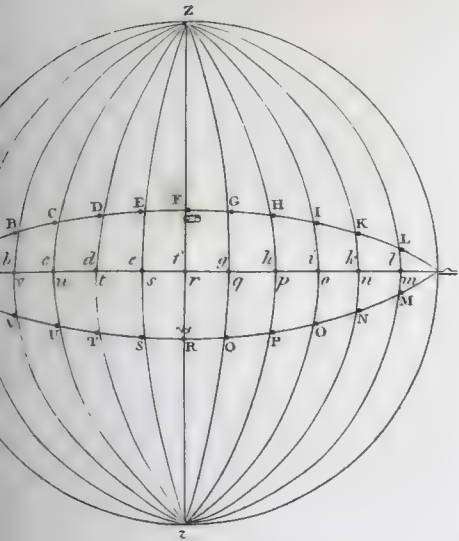


Fig. 2.



Fig. 1.

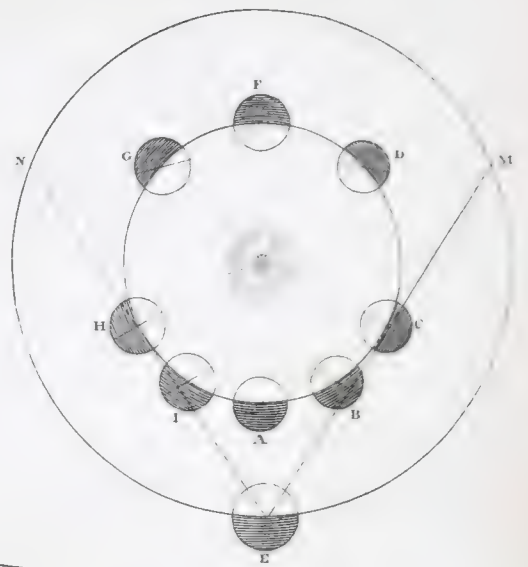


Fig. 2.

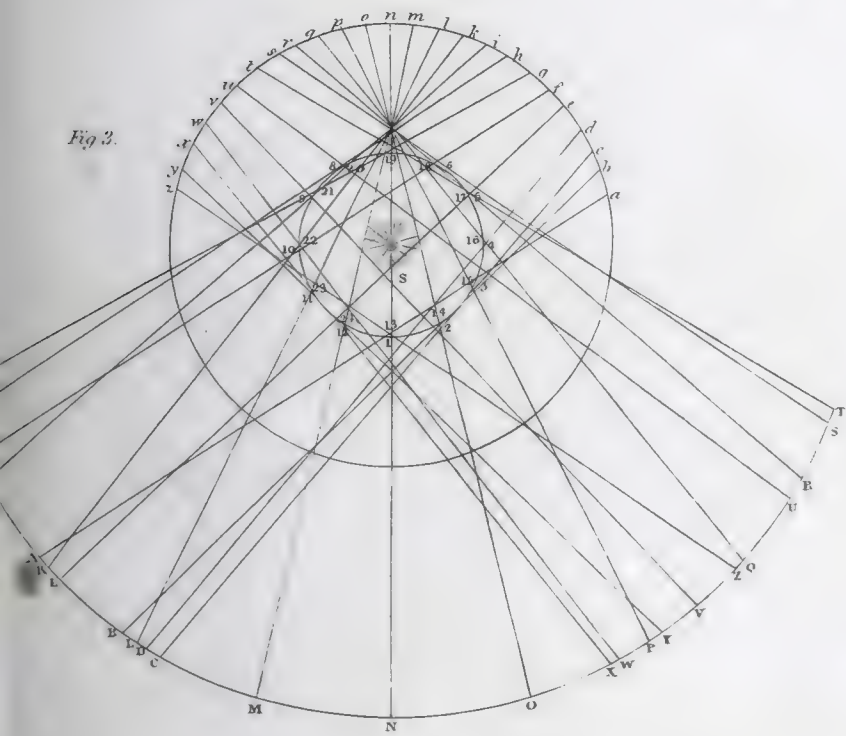


Fig. 6.

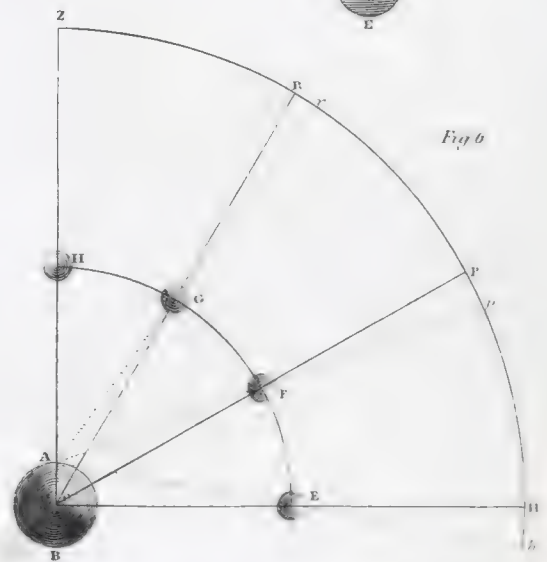


Fig. 7.



Fig. 5.

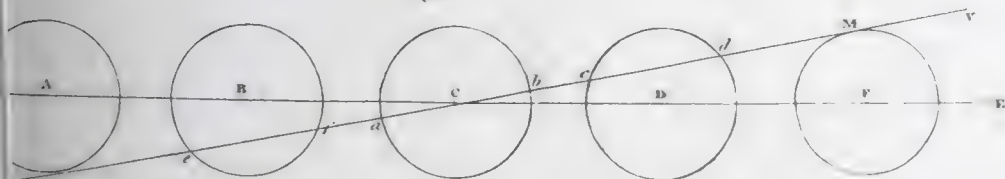


Fig. 8.

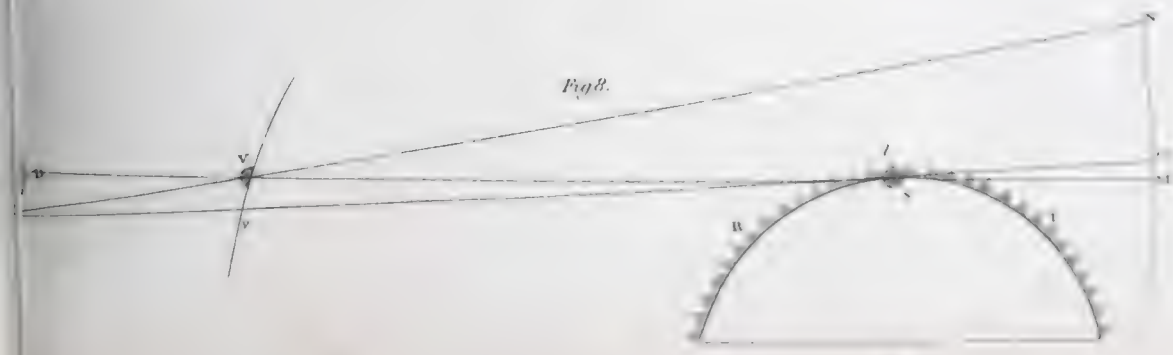




Fig 1.

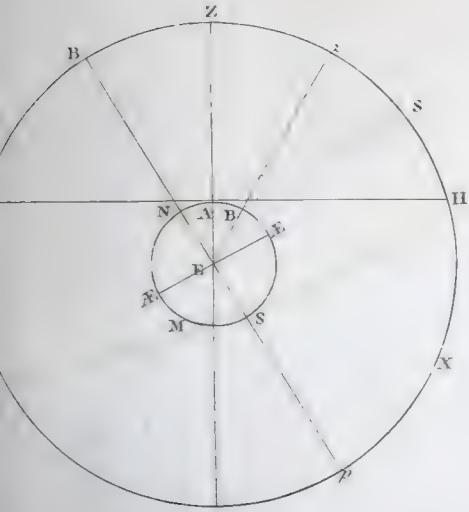


Fig 2.

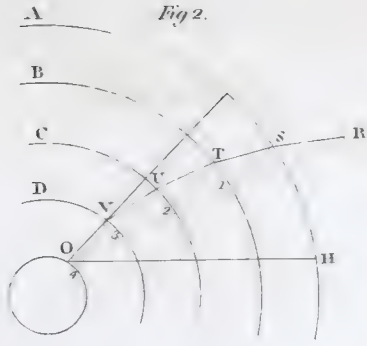


Fig 3.

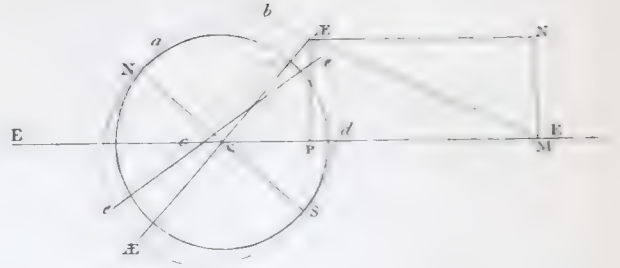


Fig 5.

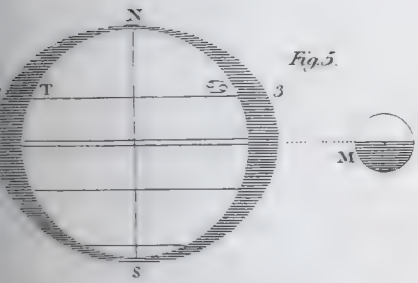


Fig 6.

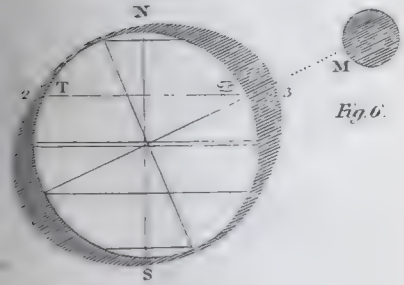


Fig 4.

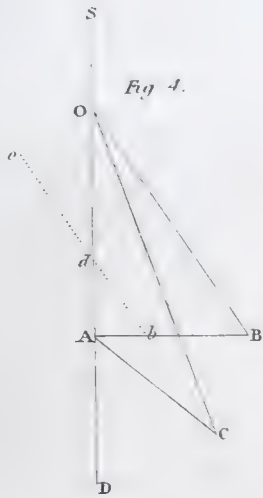


Fig 3.

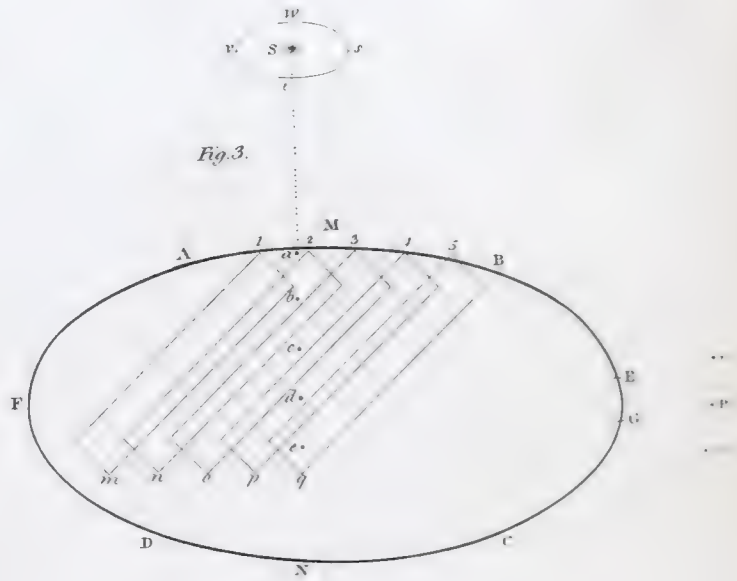


Fig 7.

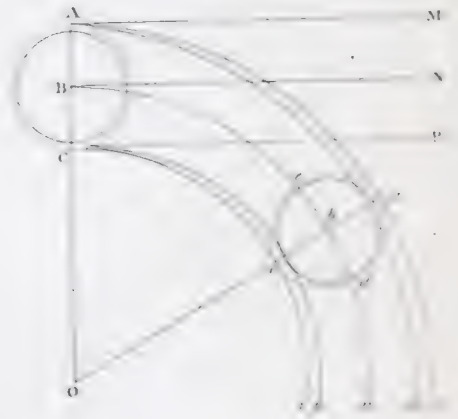


Fig 10.

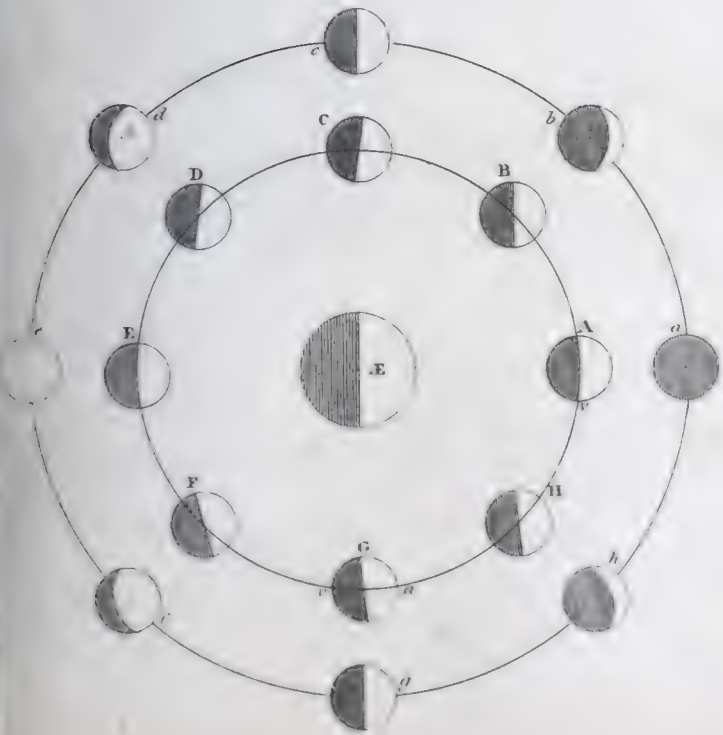


Fig 12.

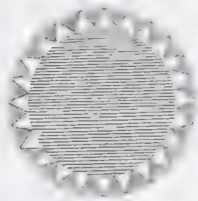


Fig 11.







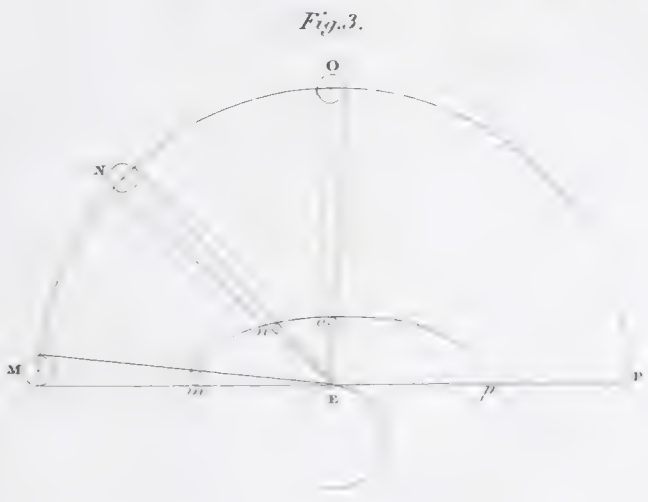
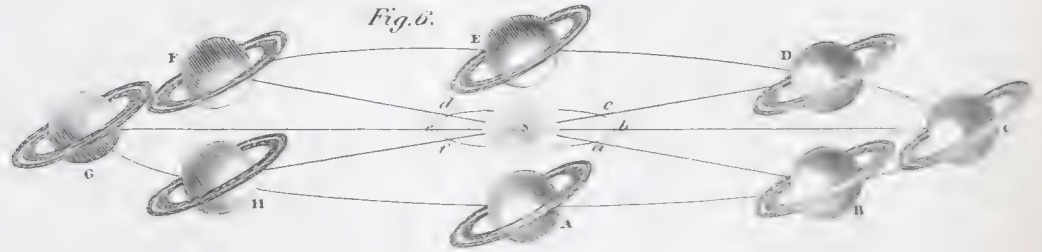
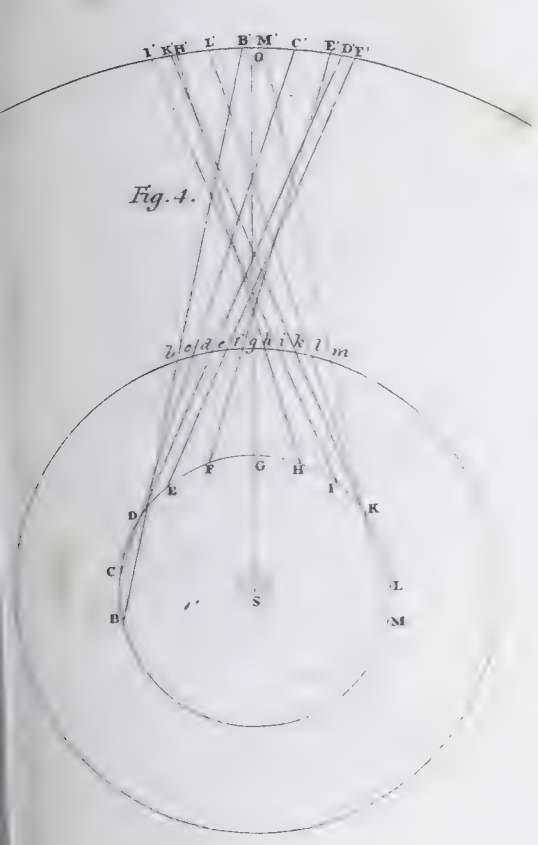
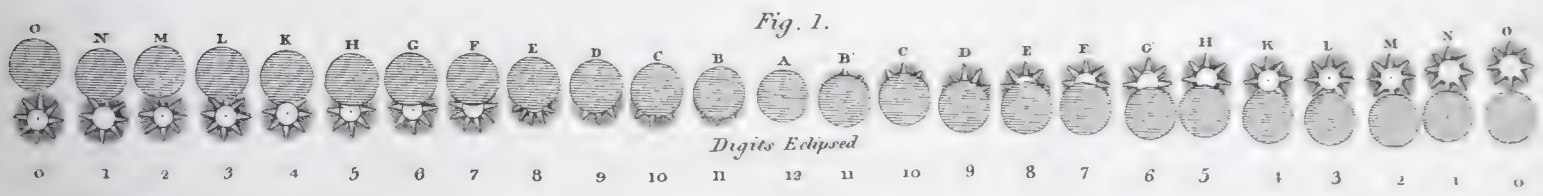
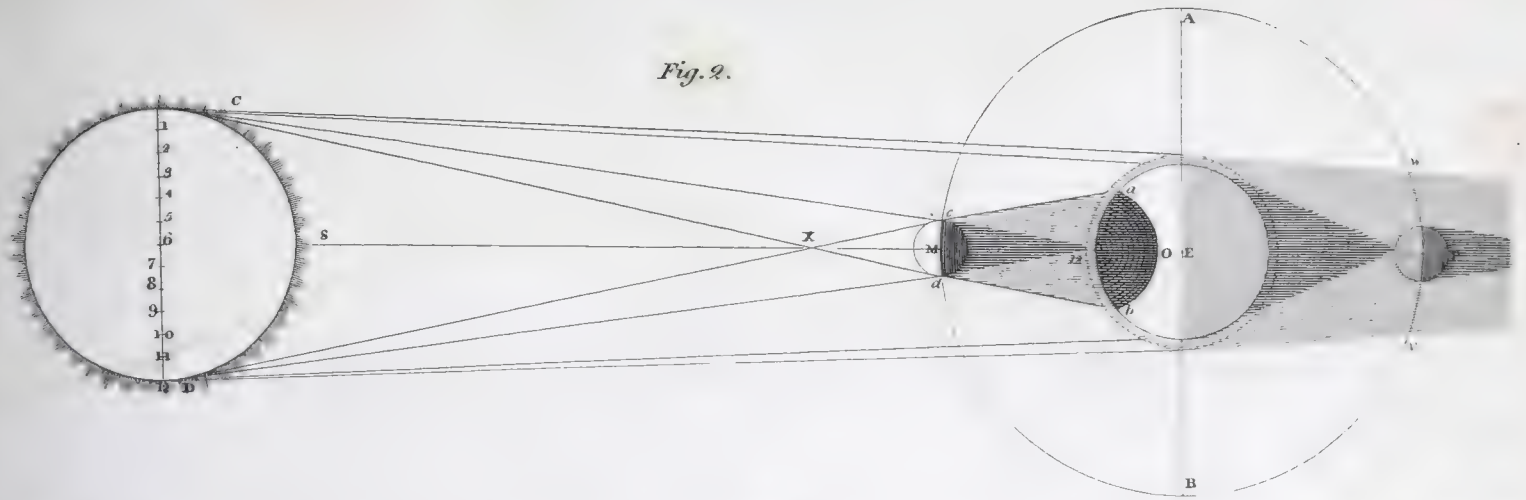
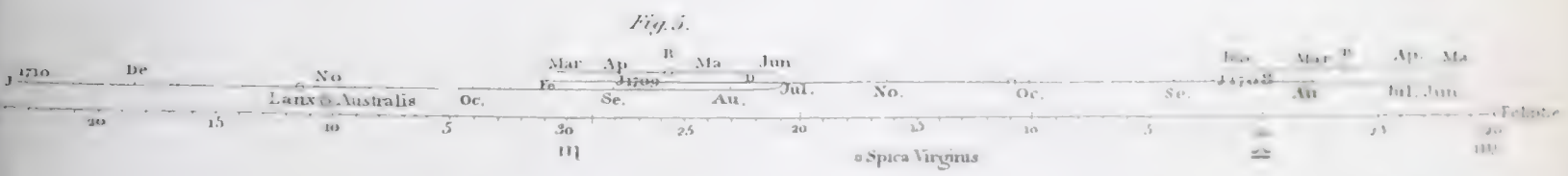


Fig 7





ASTRONOMY.

Fig. 1.

Fig. 2.

Fig. 3.

Fig. 4.

Fig. 5.

Fig. 6.

Fig. 7.

Fig. 8.

Fig. 9.

Fig. 10.

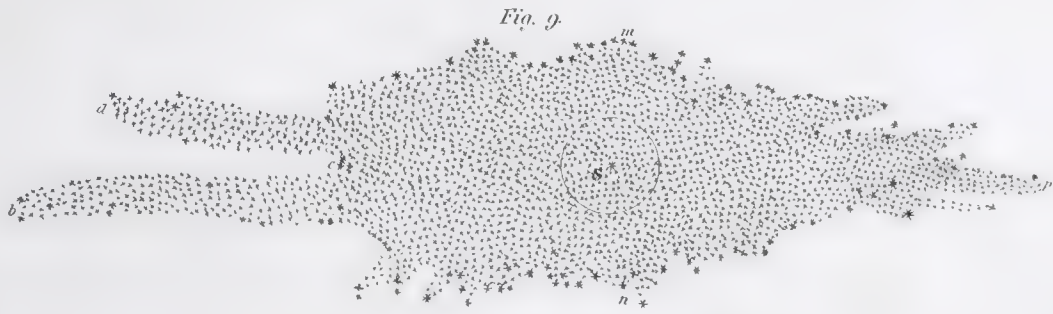
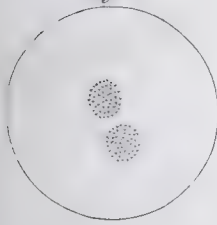
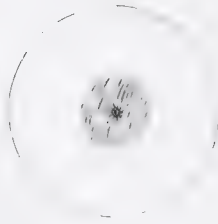
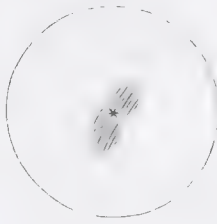
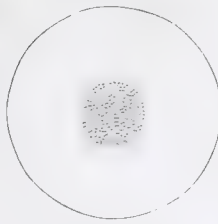
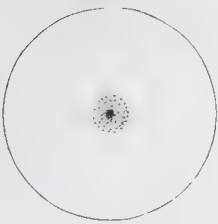


Fig. 12.

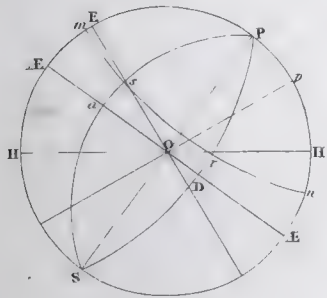


Fig. 11.

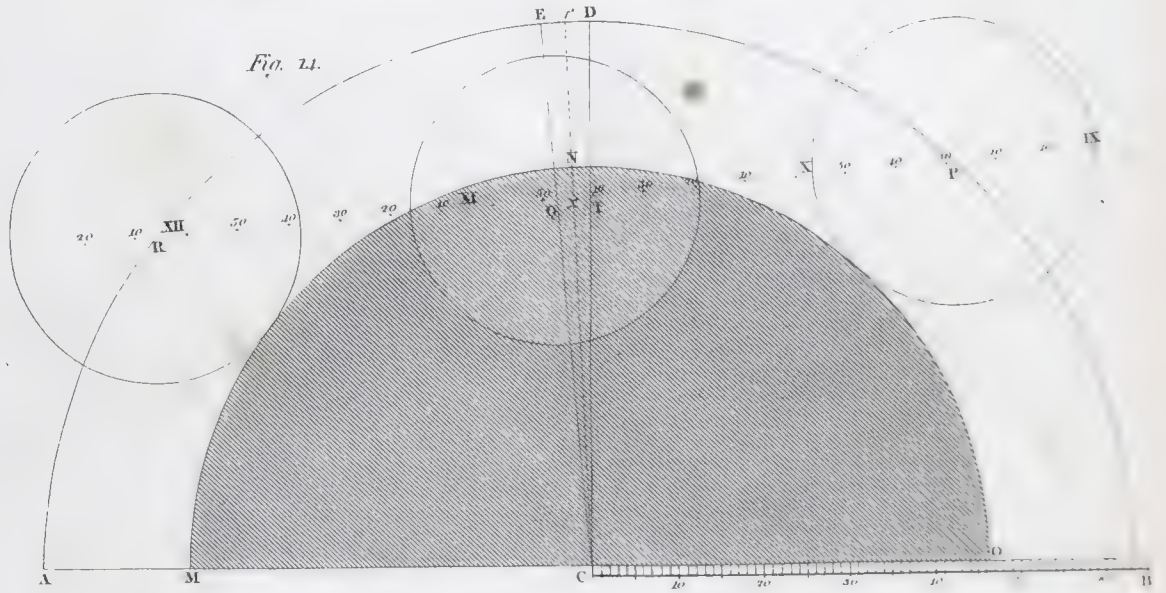


Fig. 13.

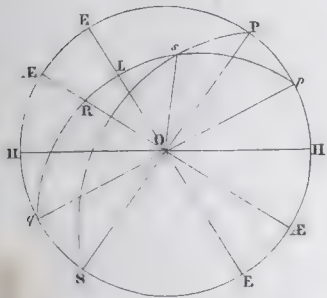


Fig. 15.

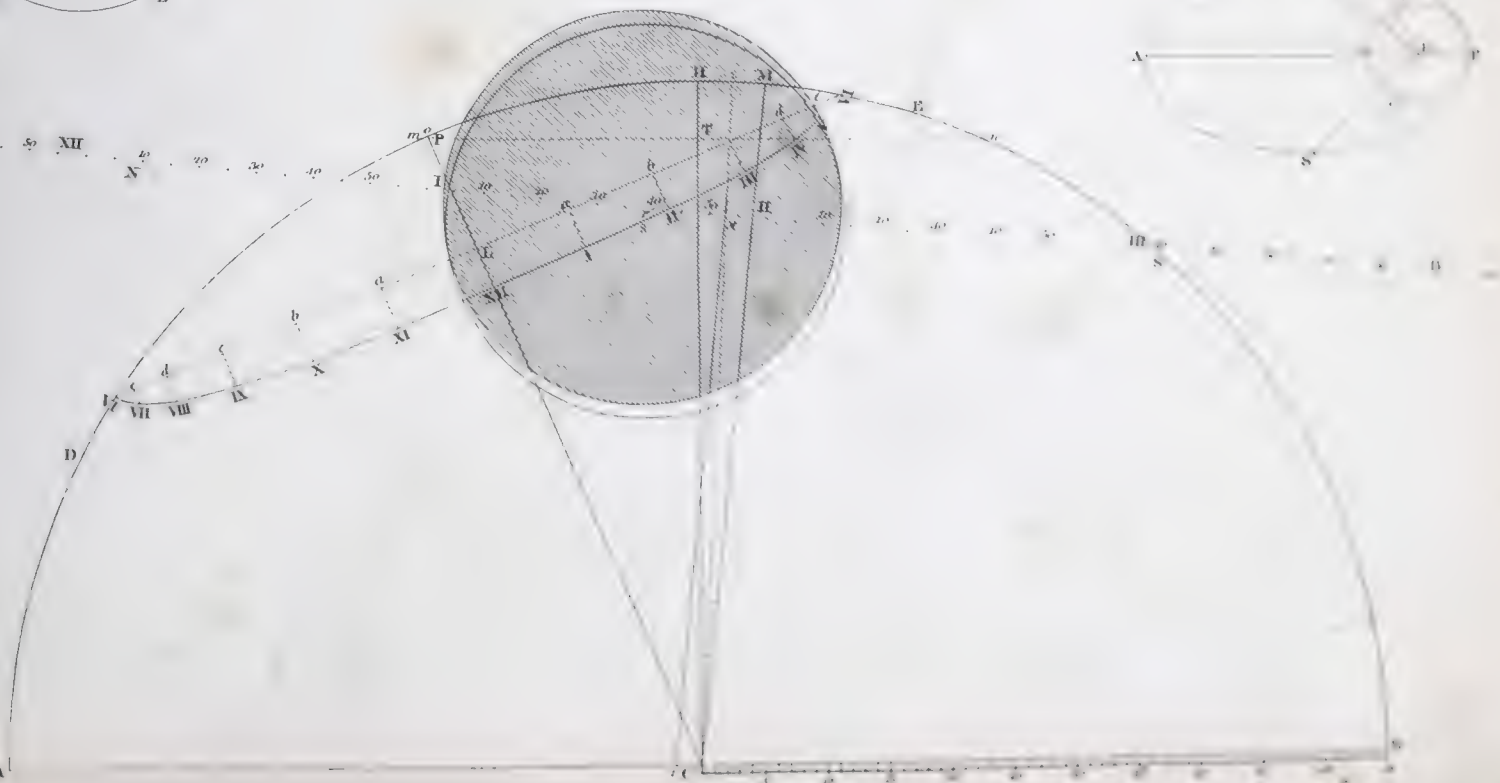


Fig. 14.





Fig. 1.

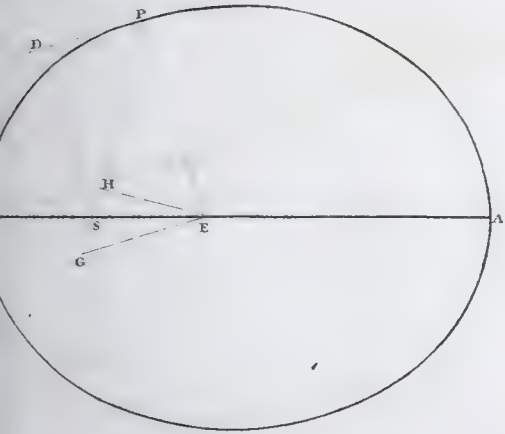


Fig. 2.

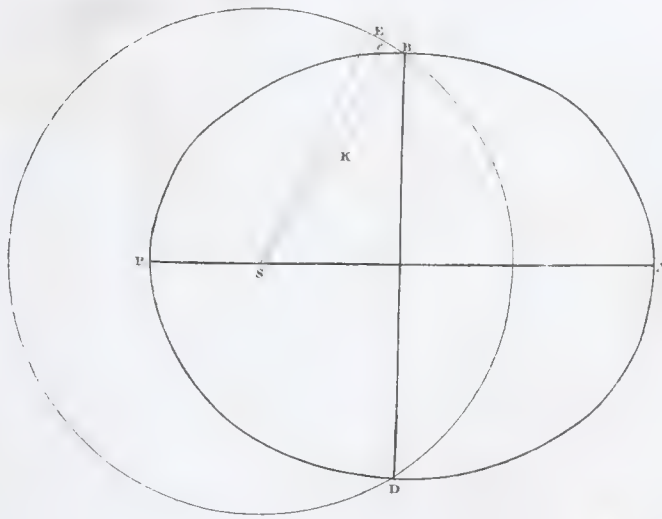


Fig. 3.

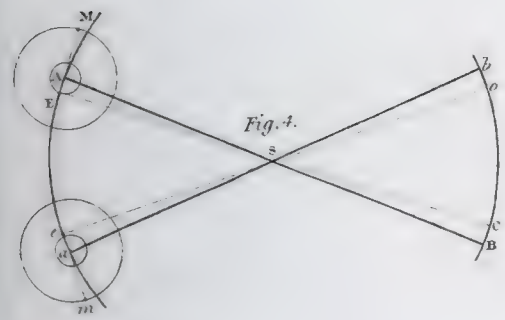


Fig. 4.

Fig. 5.

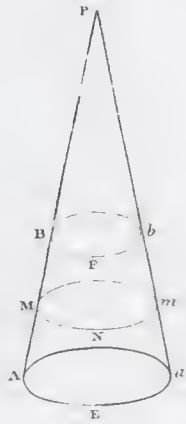


Fig. 6.

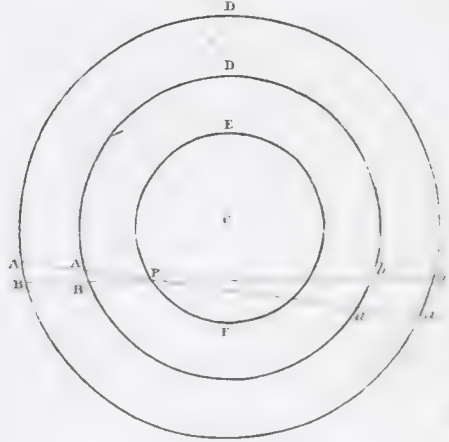


Fig. 7.

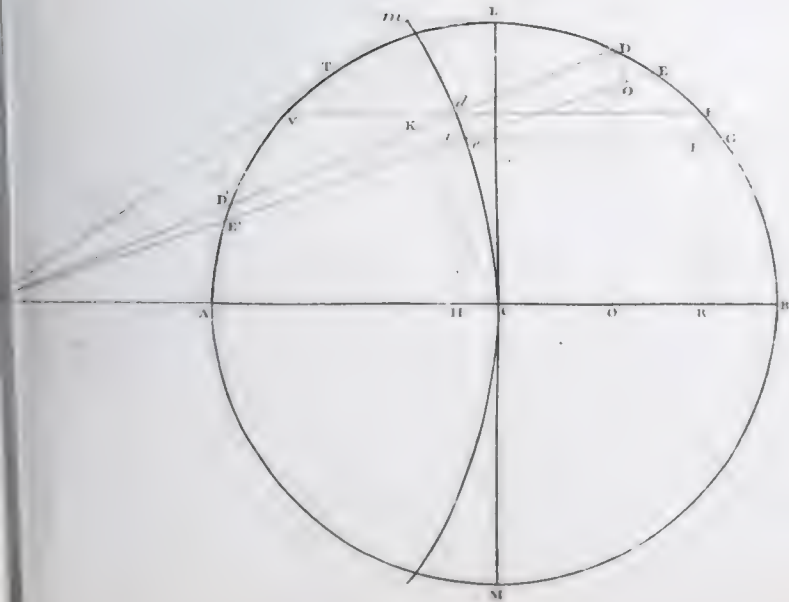


Fig. 8.

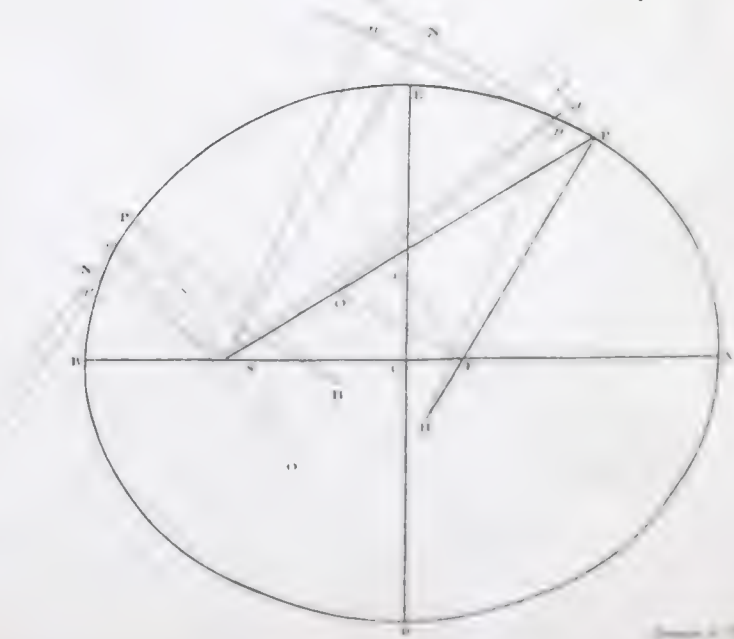




Fig. 1.

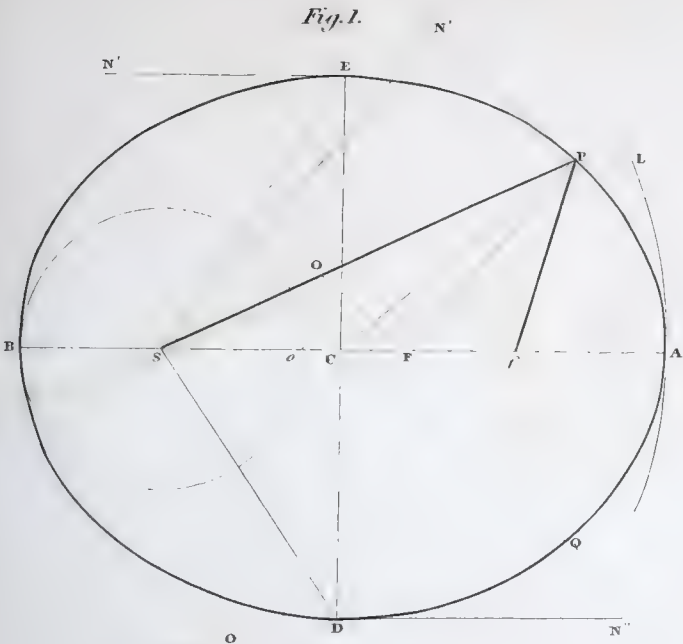


Fig. 3.

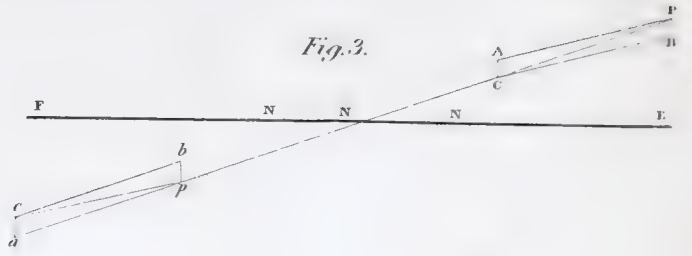


Fig. 4.

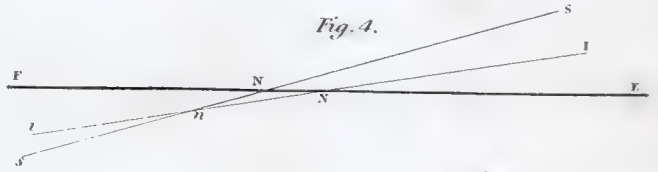


Fig. 5.

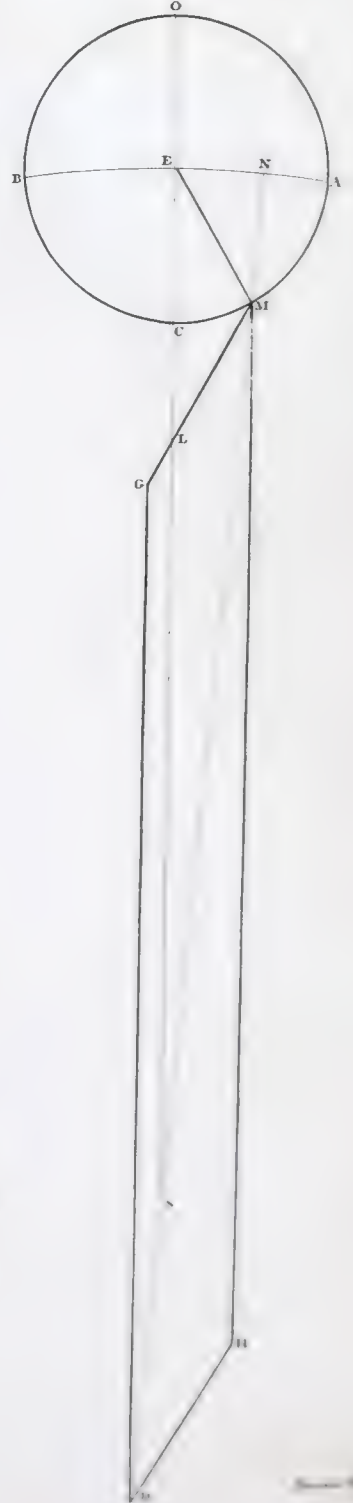


Fig. 2.



Fig. 6.

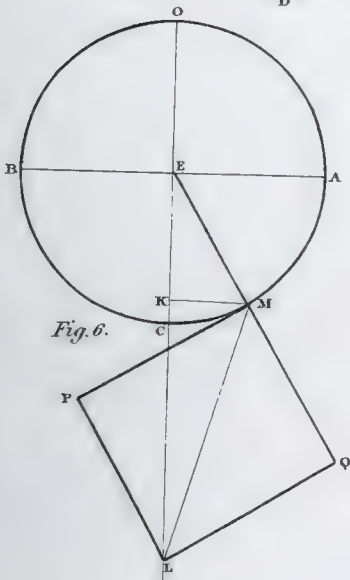


Fig. 7.

s

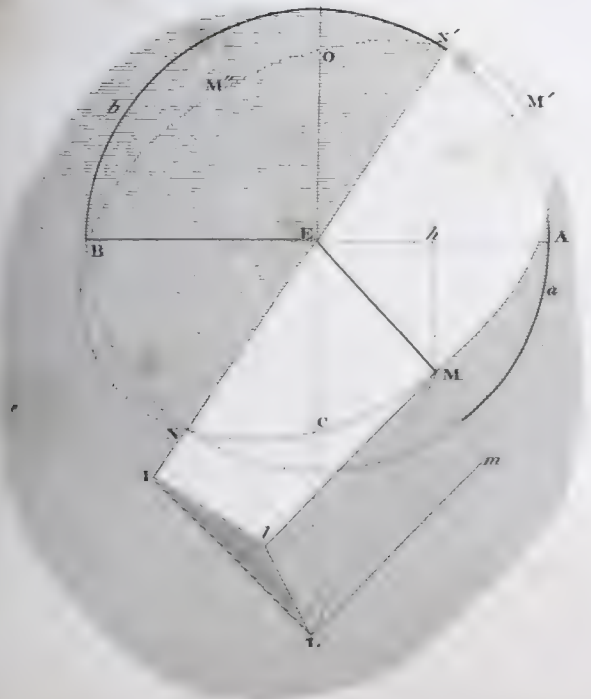


Fig. 8.

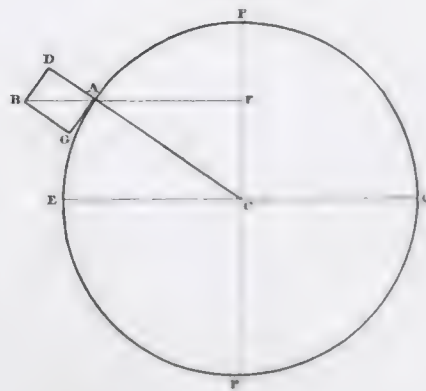






Fig. 1.

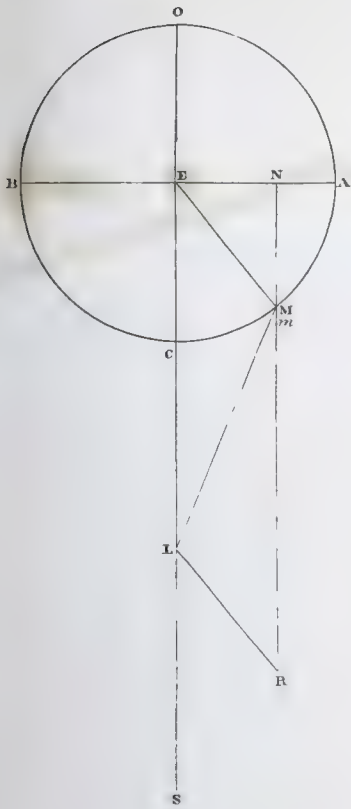


Fig. 2.



Fig. 5.

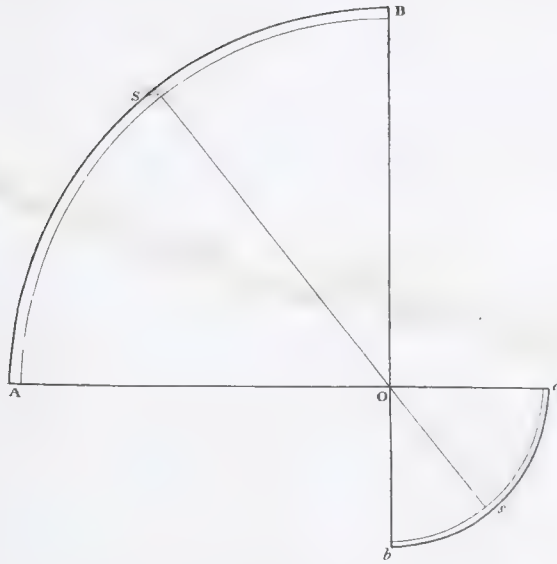


Fig. 6.  
ASTRONOMICAL QUADRANT.

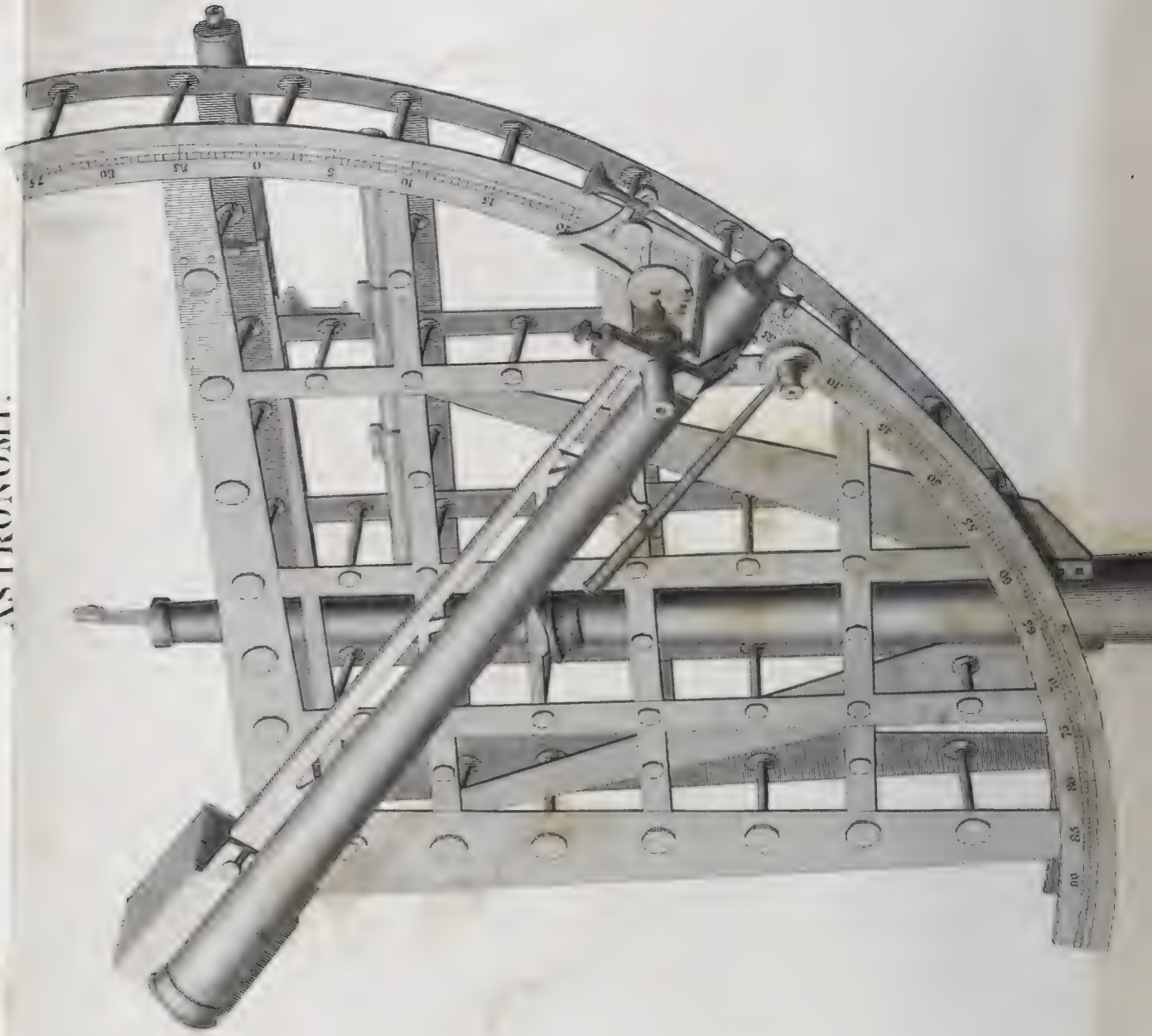


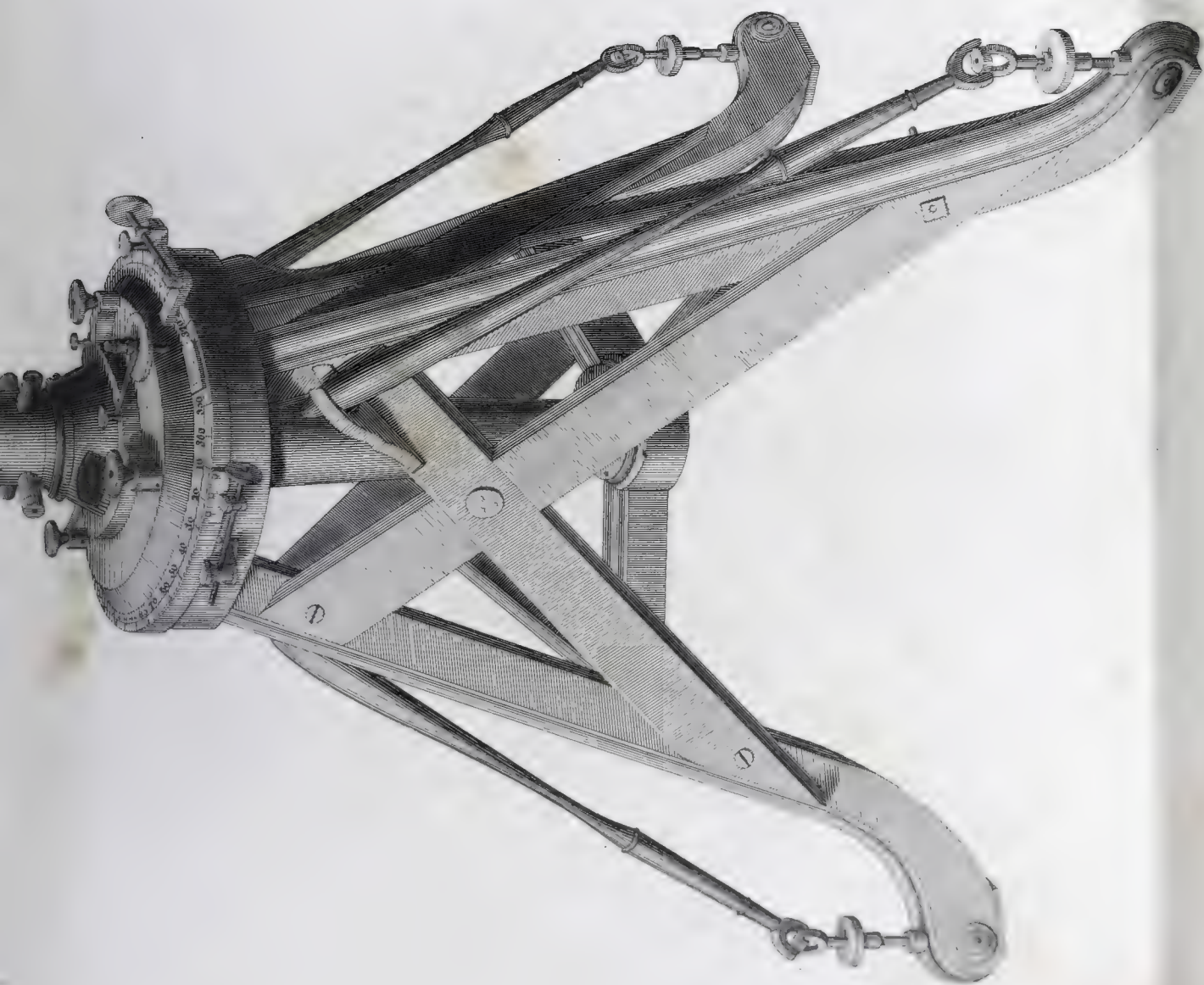
Fig. 3.



Fig. 4.







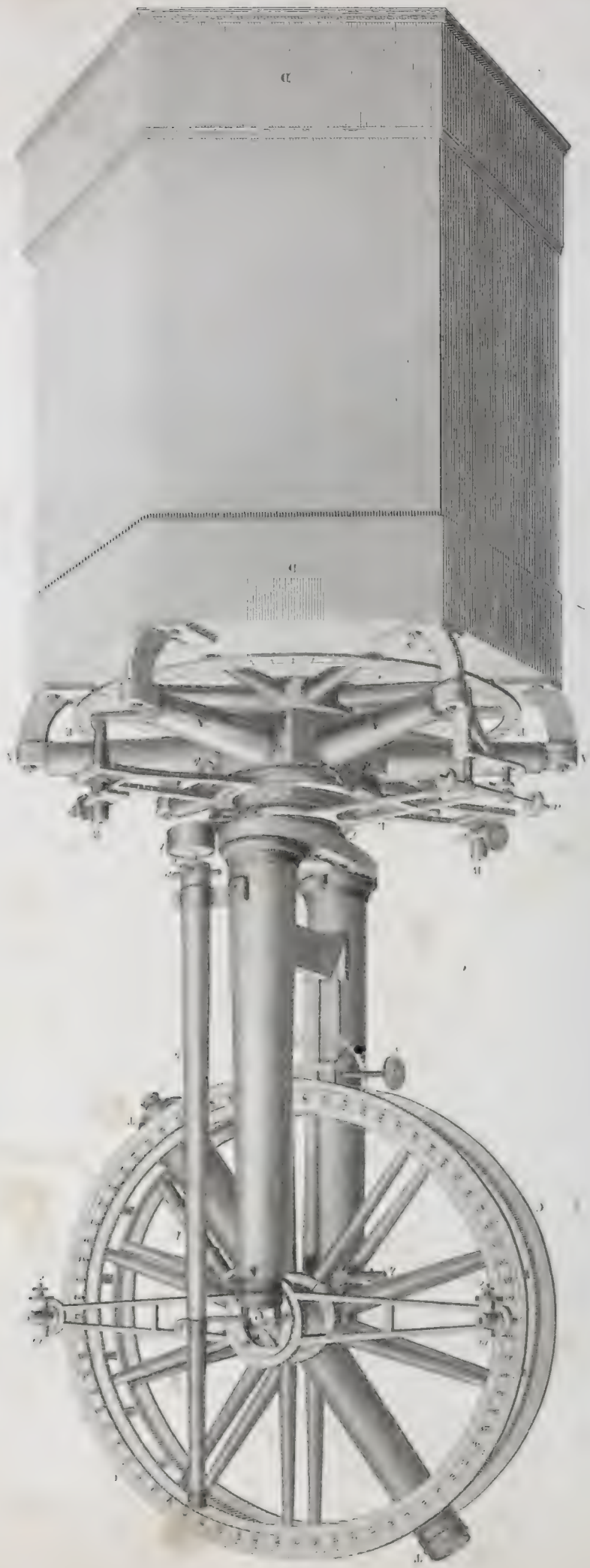
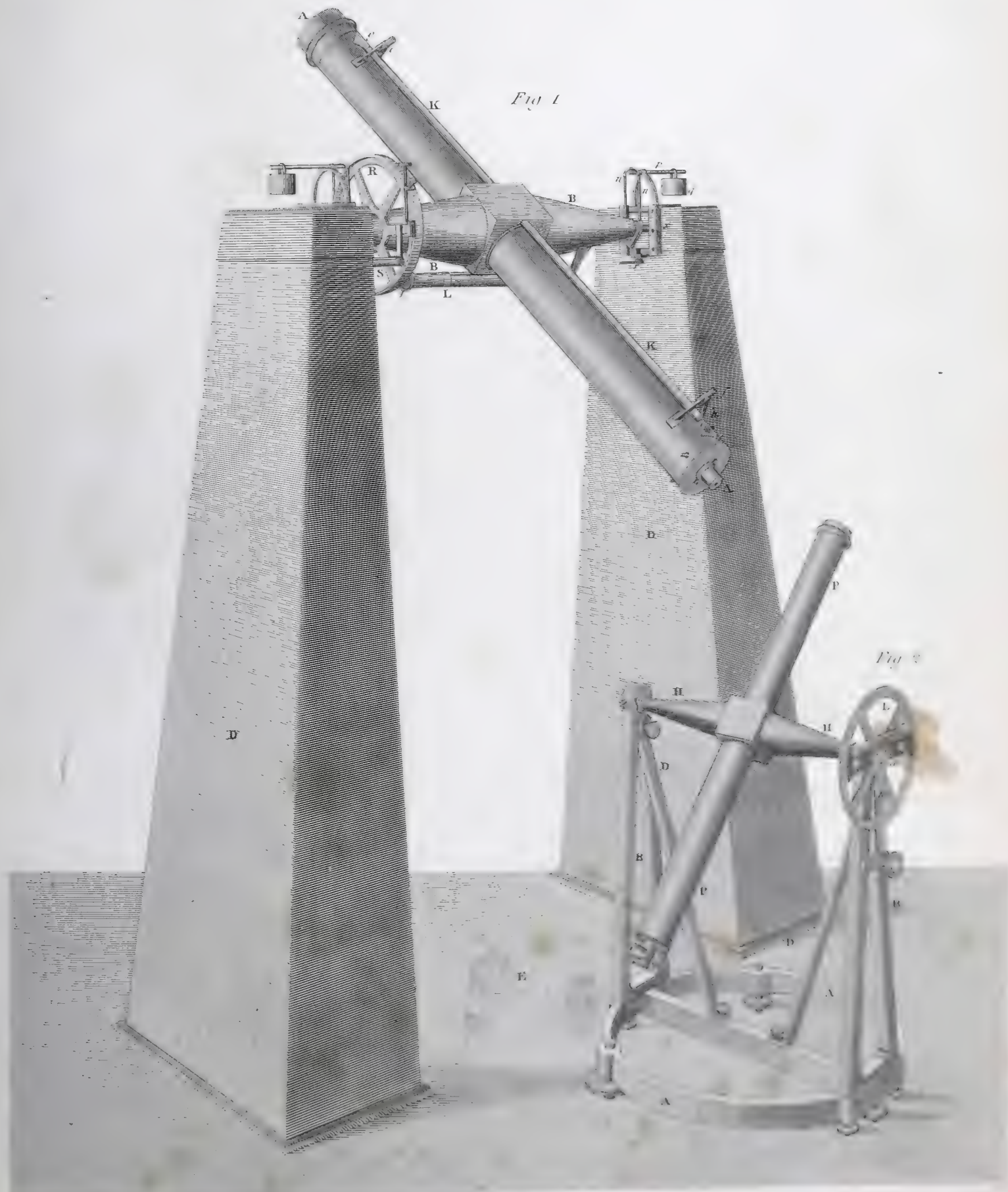
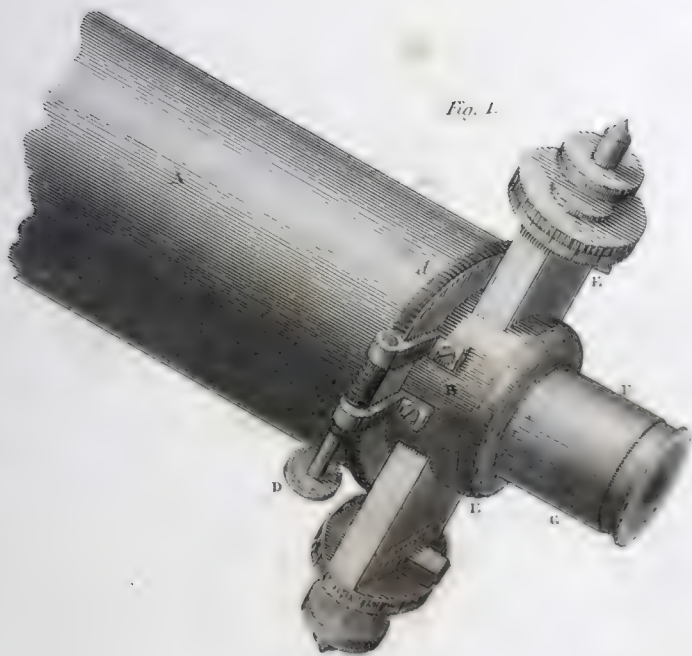
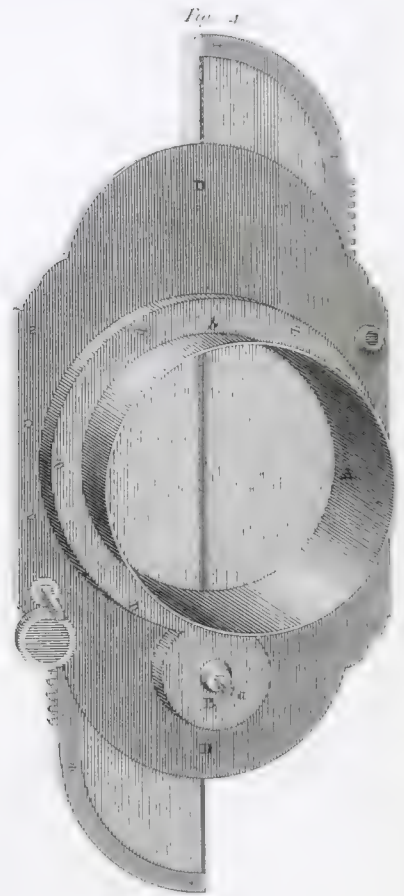
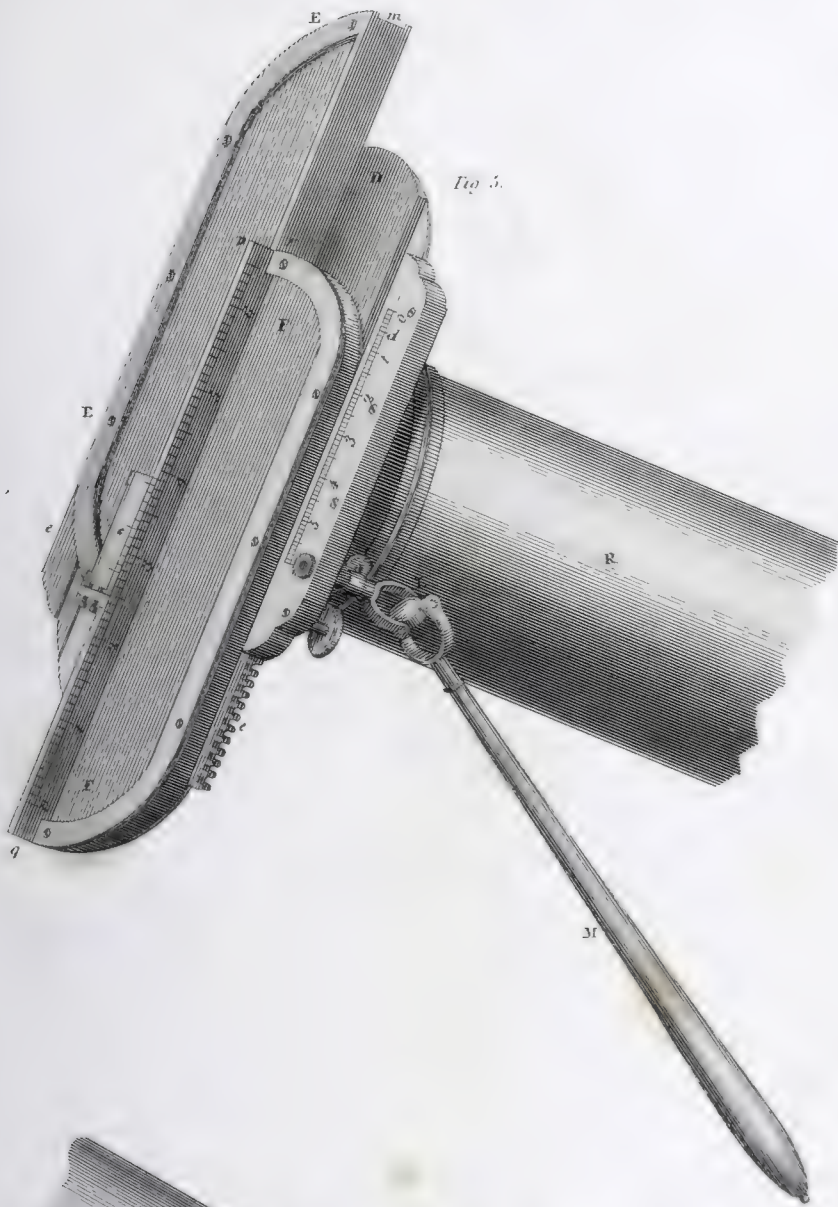


Fig 1











# ATTRACTION.

Fig. 2.

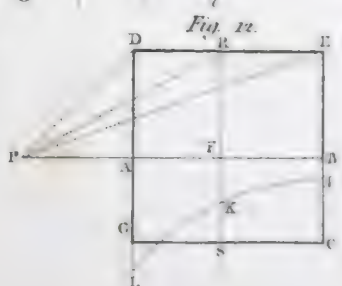
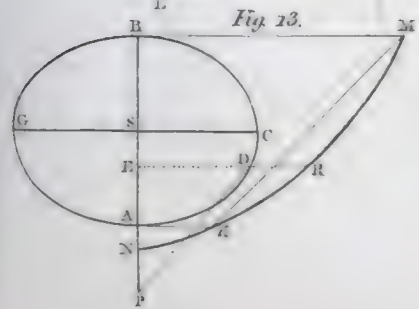
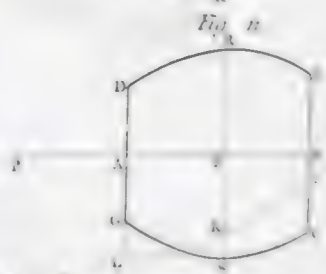
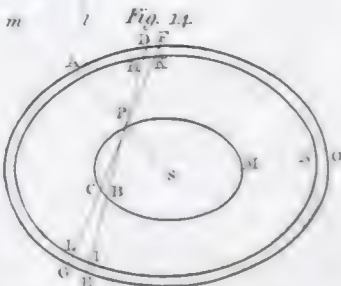
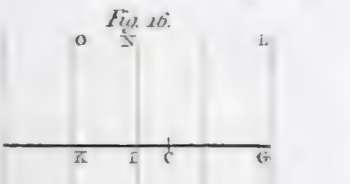
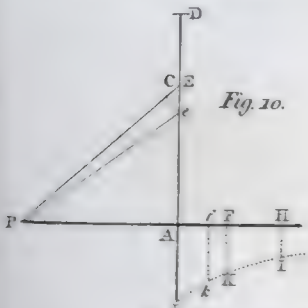
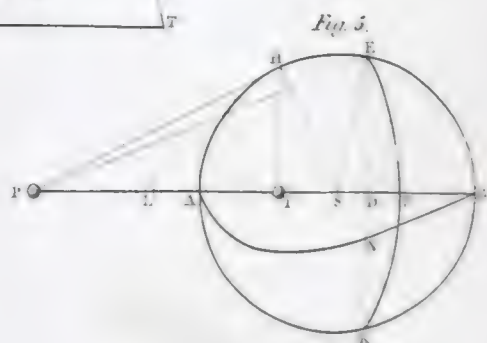
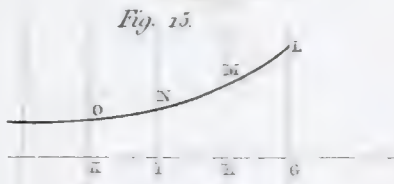
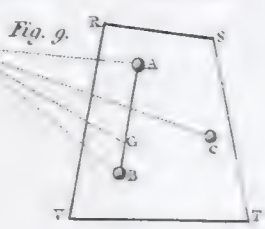
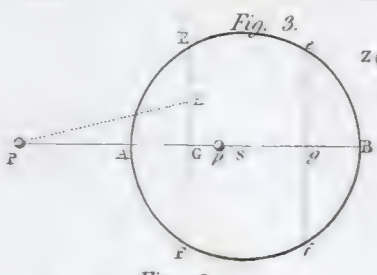
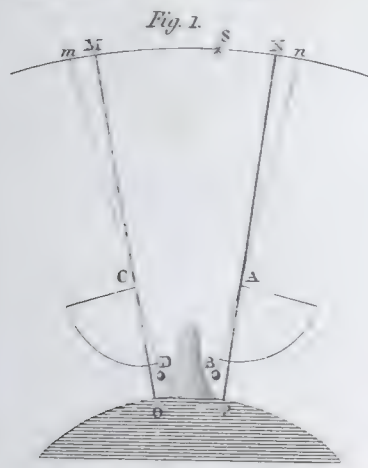
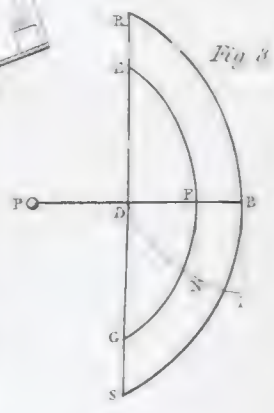
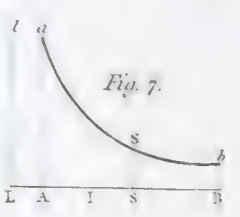
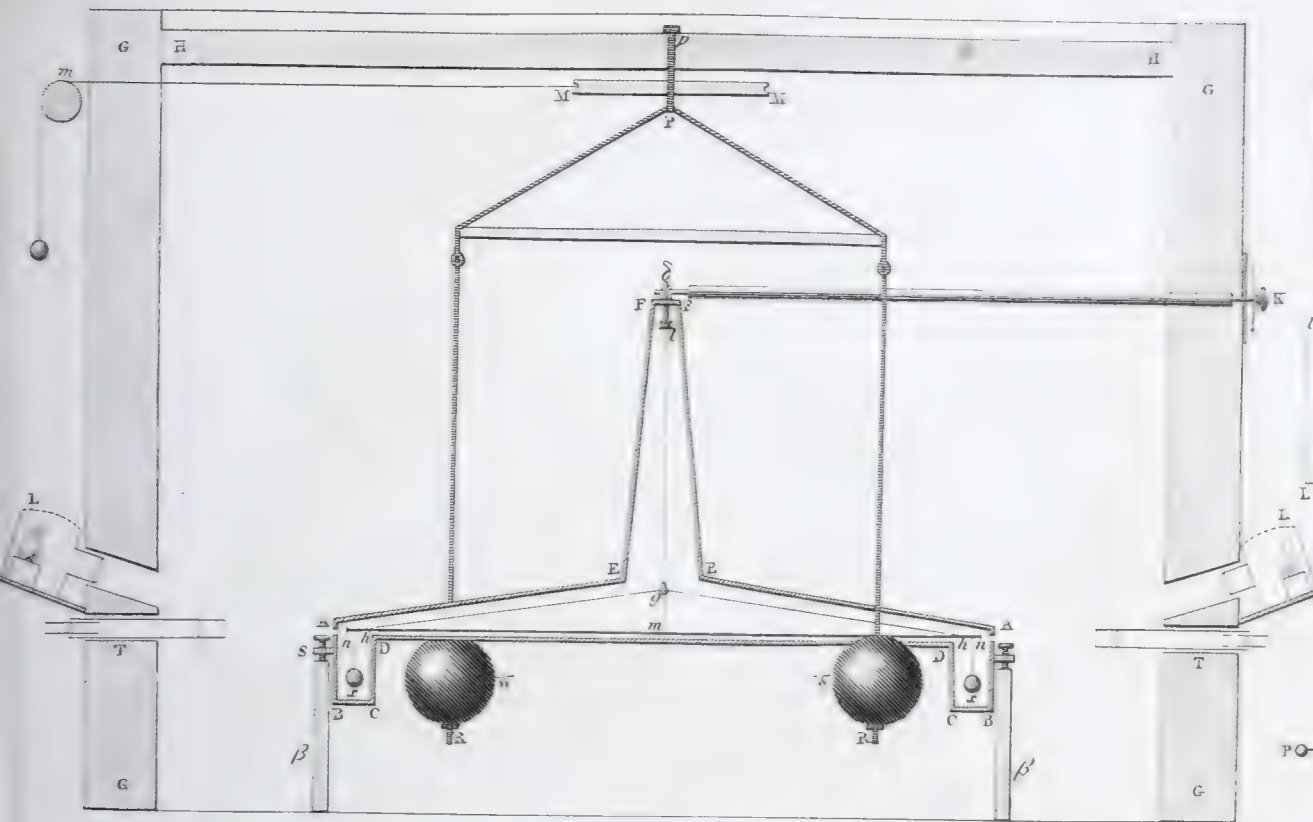




Fig. 1.

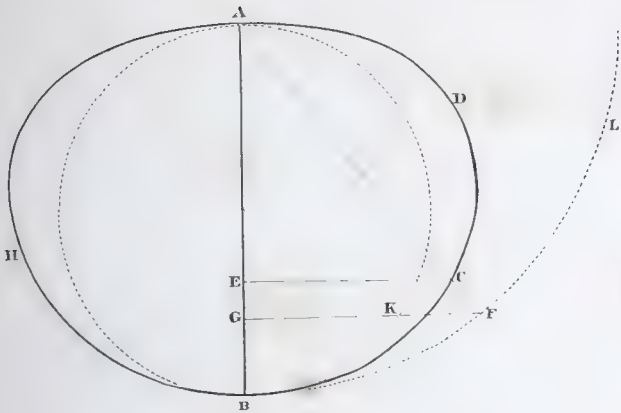


Fig. 2.

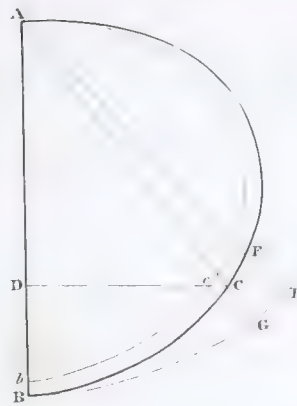


Fig. 3.

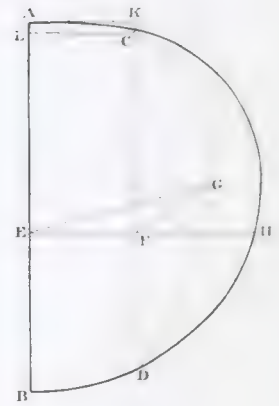


Fig. 3.

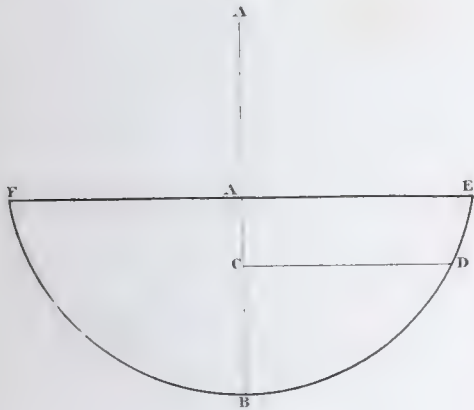


Fig. 6.

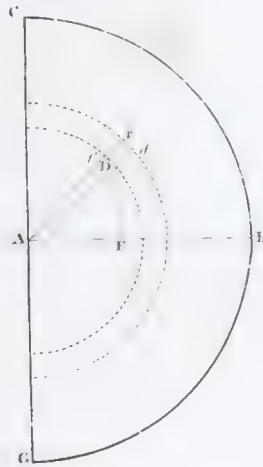


Fig. 5.



Fig. 7.

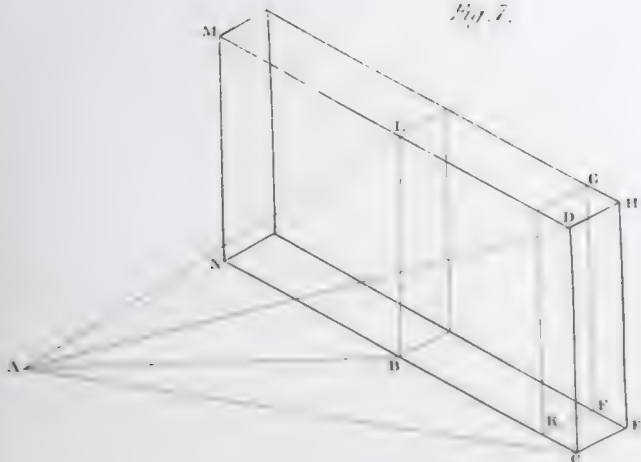


Fig. 8.

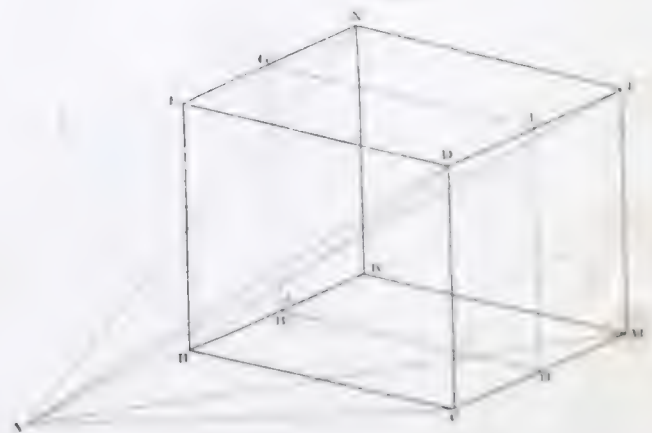




Fig. 1.

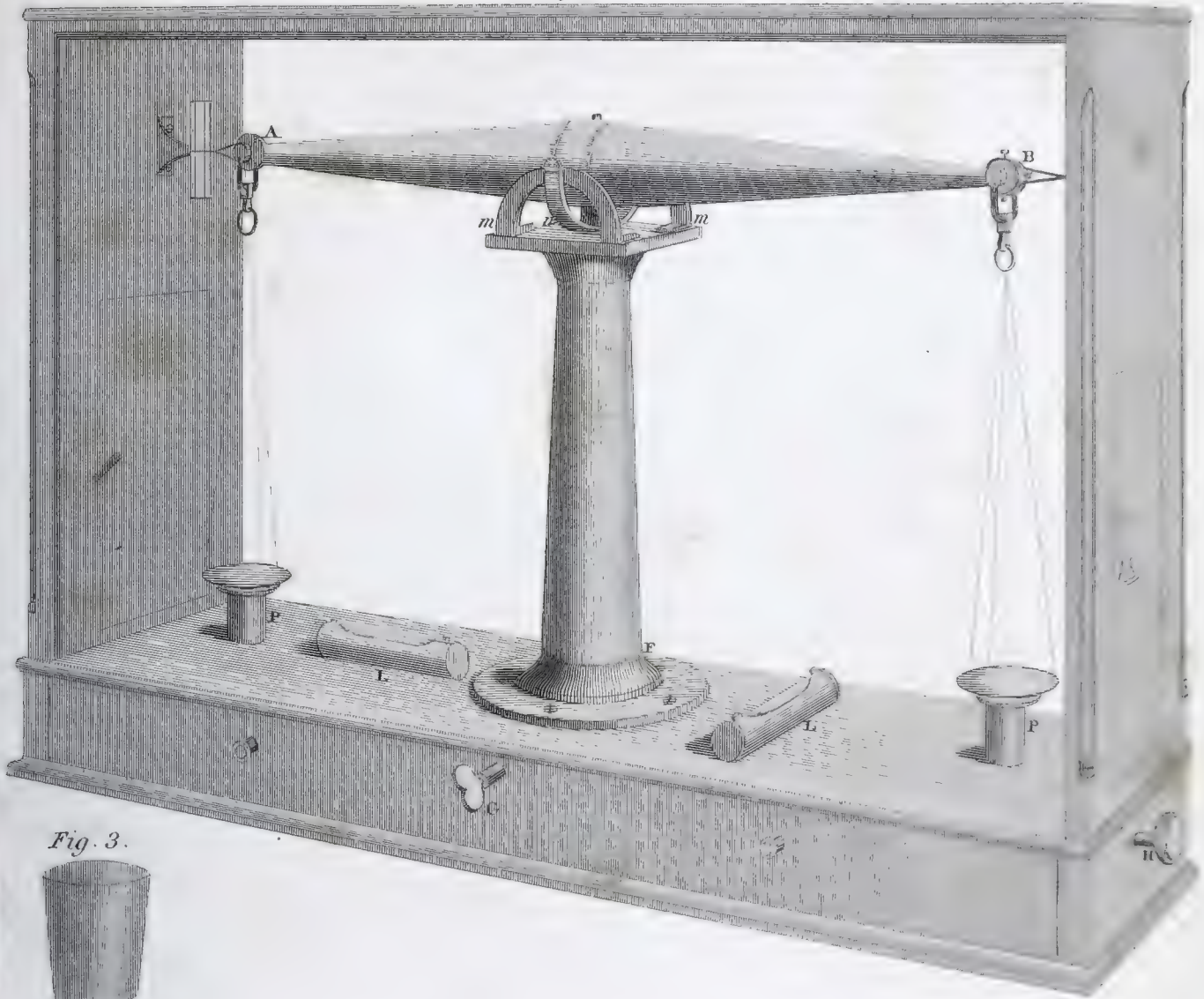


Fig. 3.

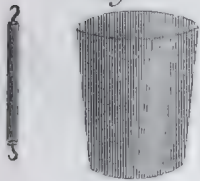


Fig. 2.

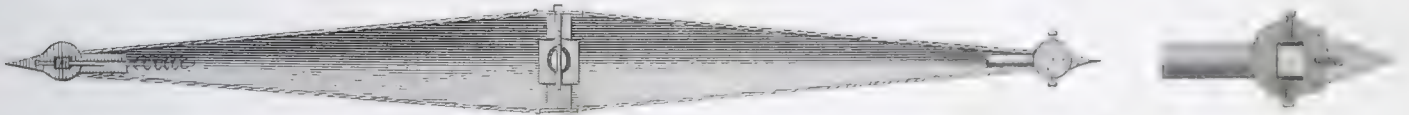


Fig. 4.





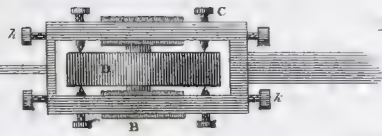


Fig 2

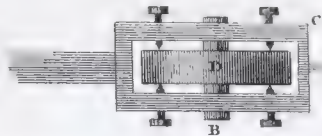
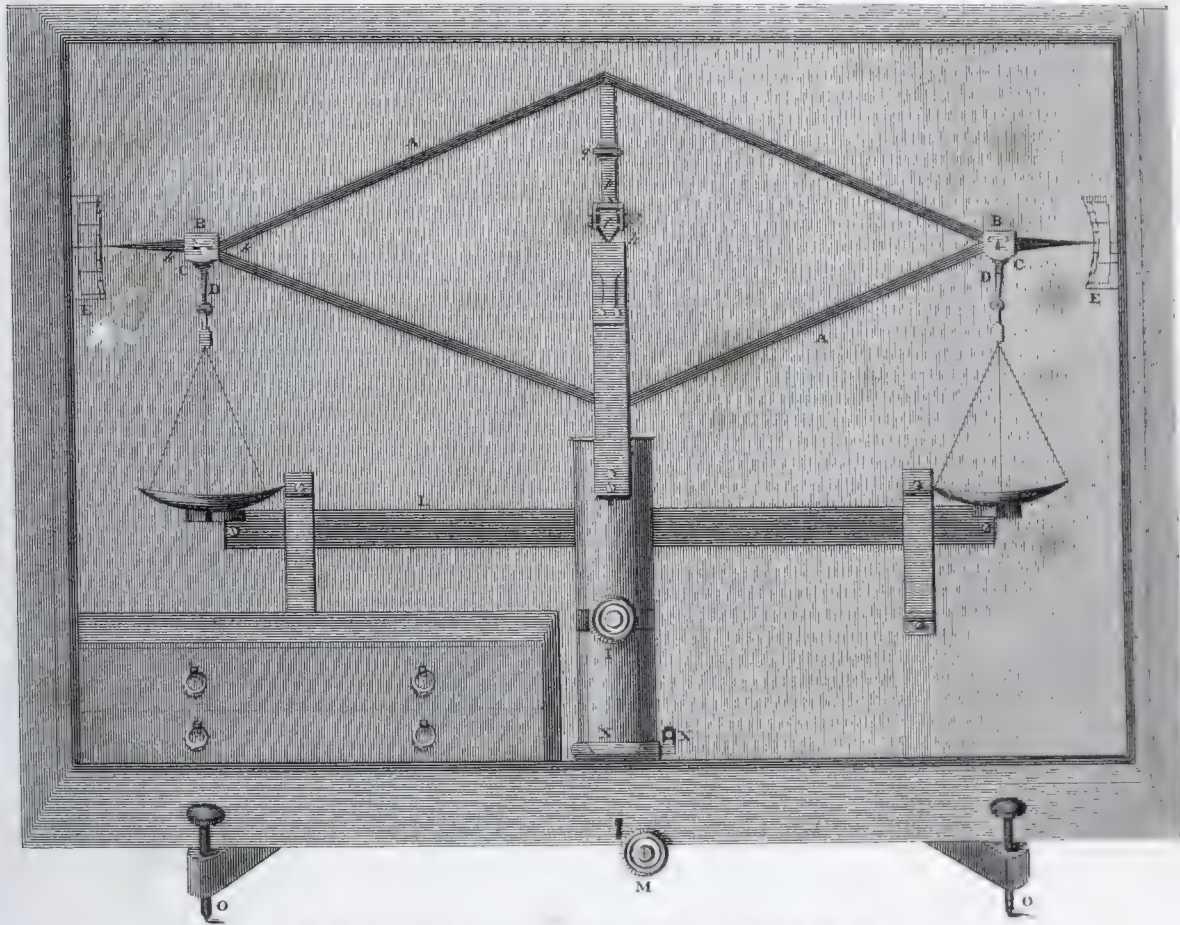


Fig 1



BANDANA HANDKERCHIEFS

British Imitation

Fig 3

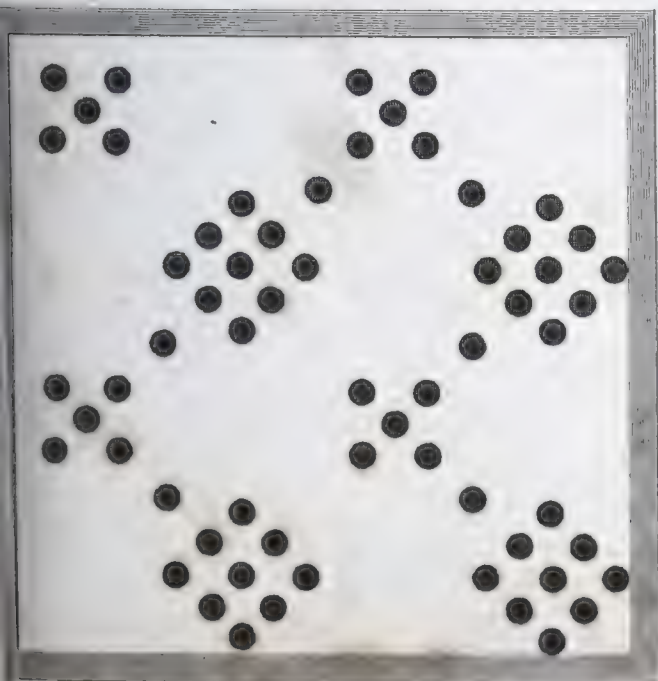
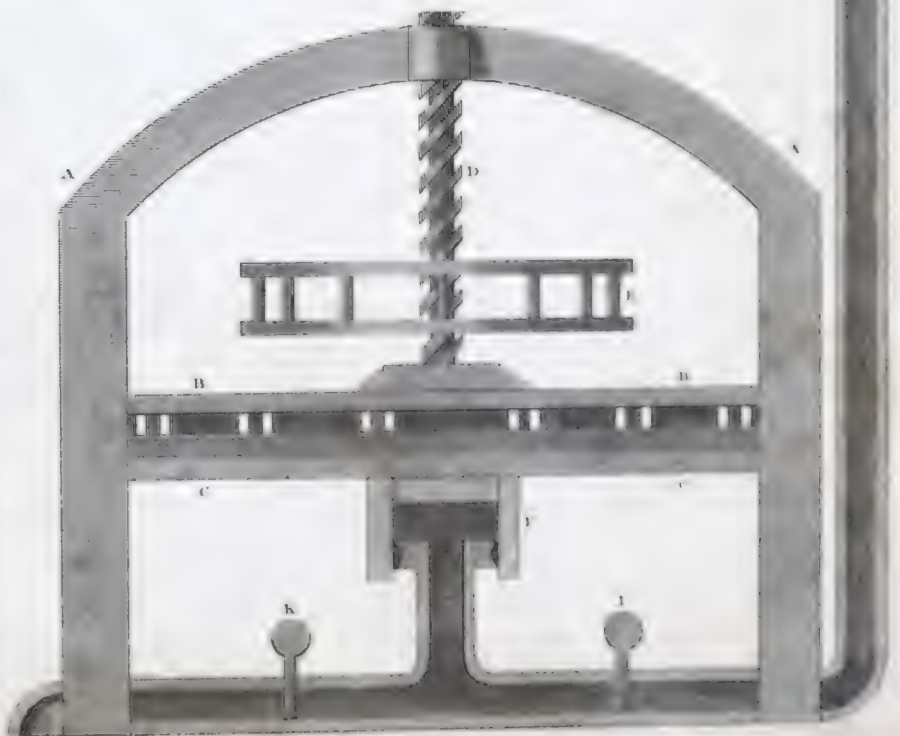


Fig 4







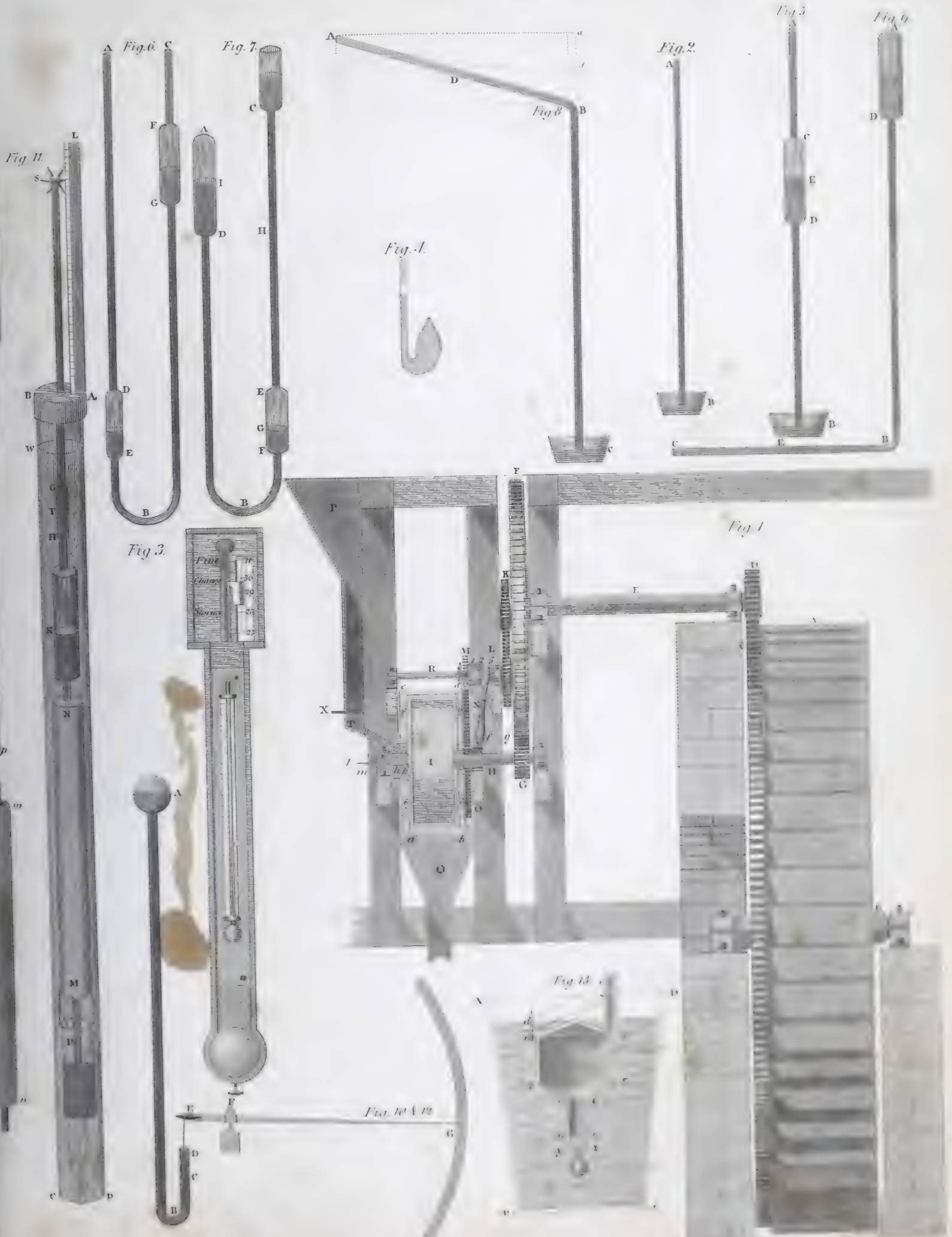




Fig. 1.



Fig. 2.

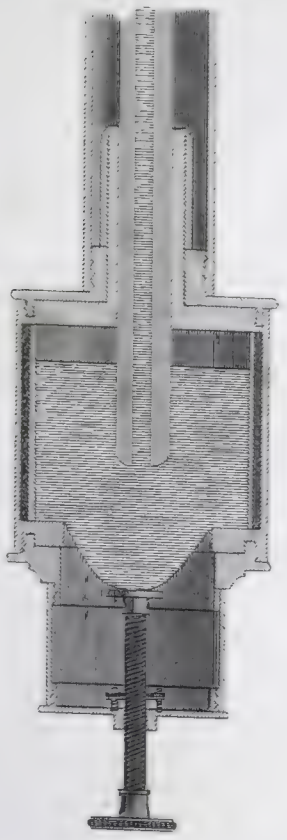


Fig. 9.

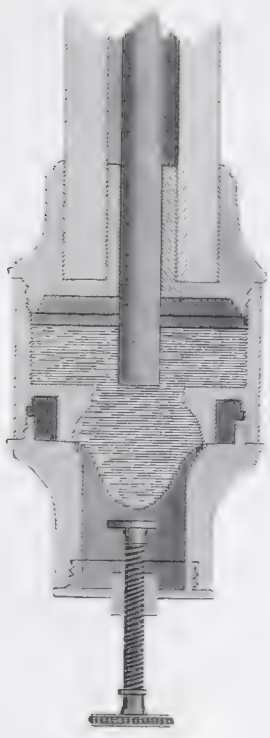


Fig. 10.

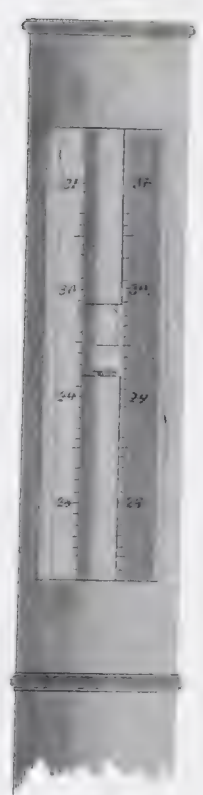


Fig. 1



Fig. 5.

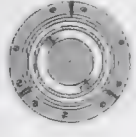


Fig. 3.



Fig. 6.



Fig. 7.



Fig. 11.

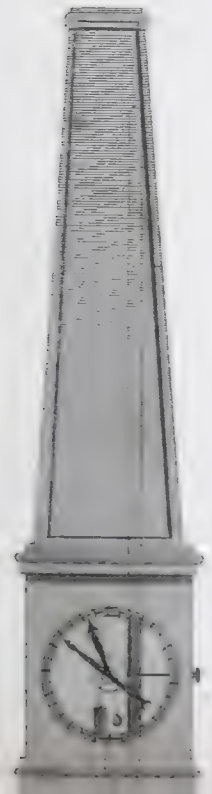


Fig. 8.



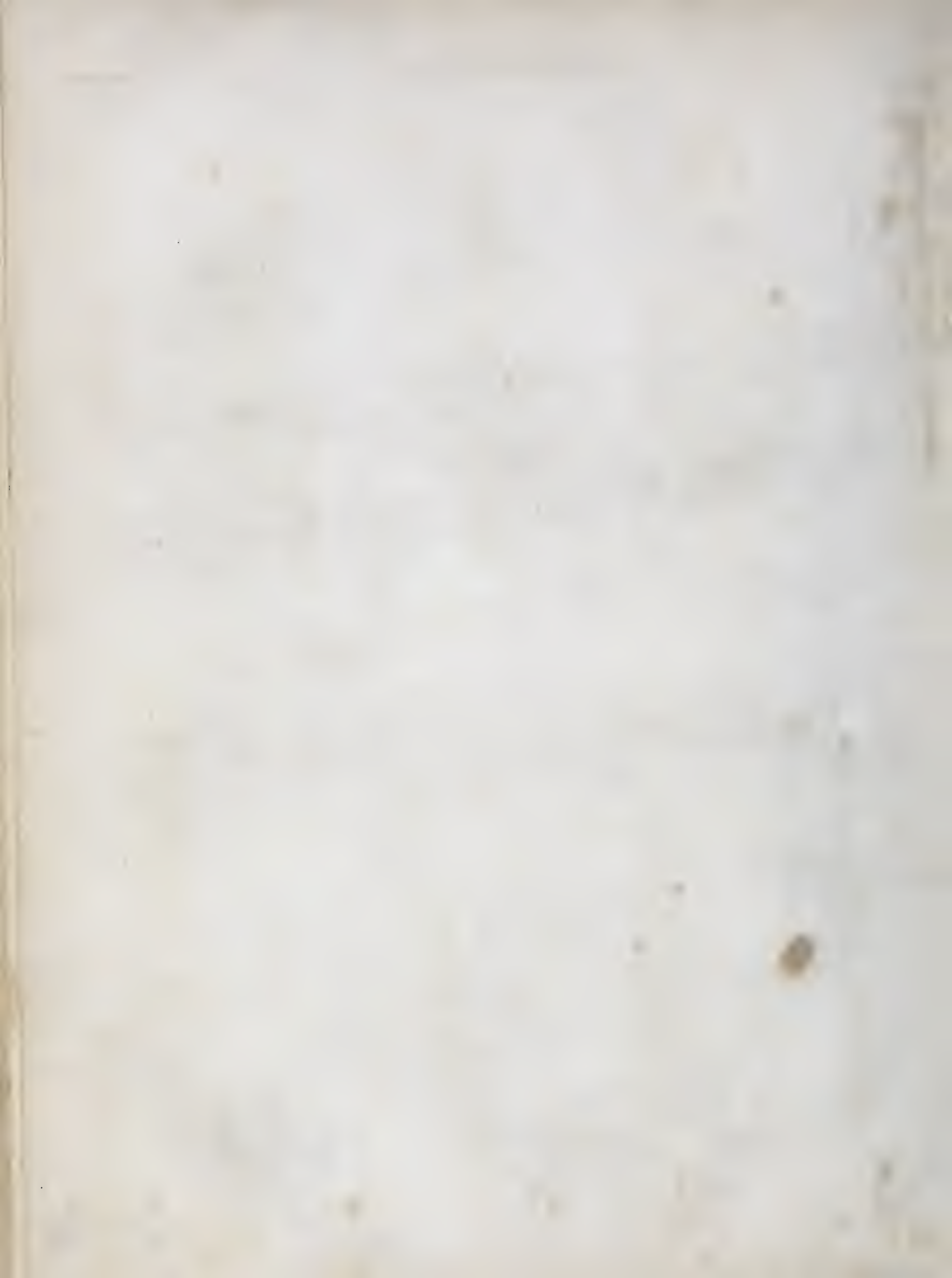


Fig. 1.

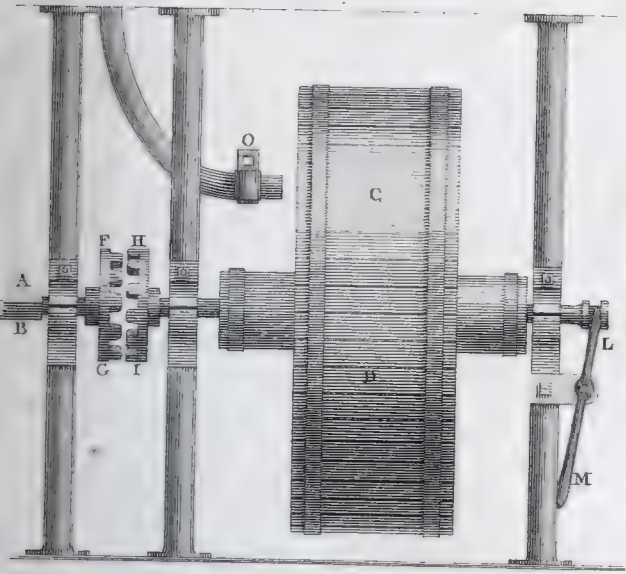


Fig. 2.

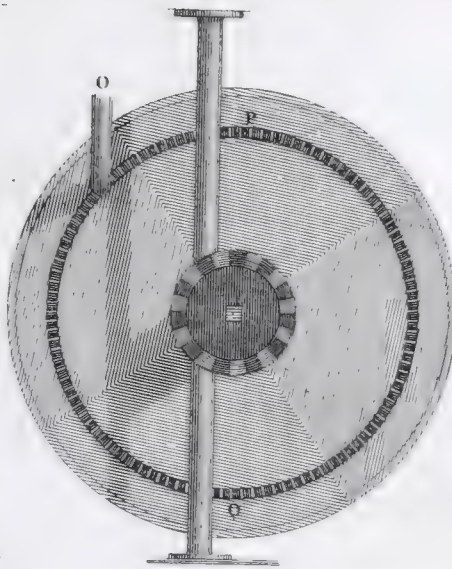


Fig. 3.

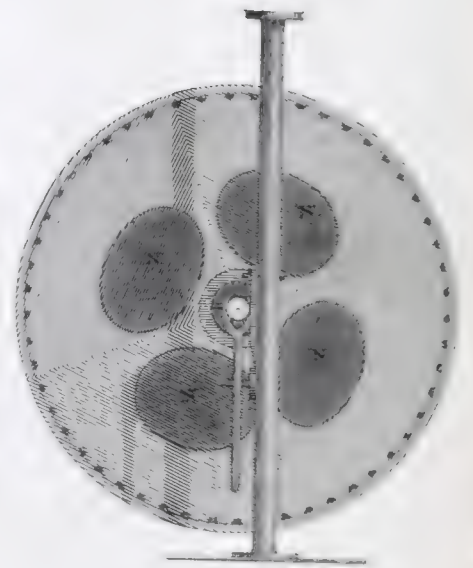


Fig. 4.

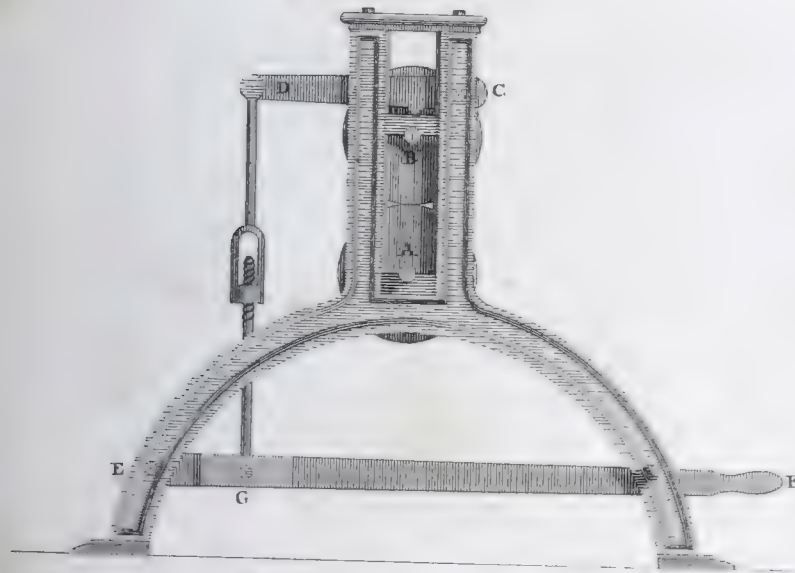


Fig. 5.

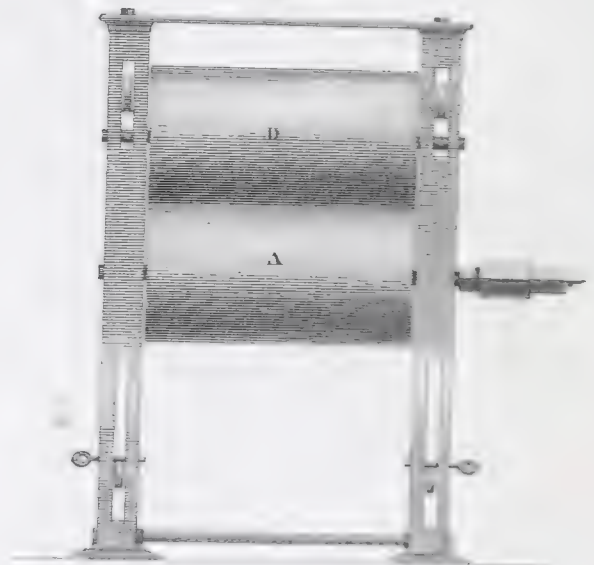


Fig. 6.

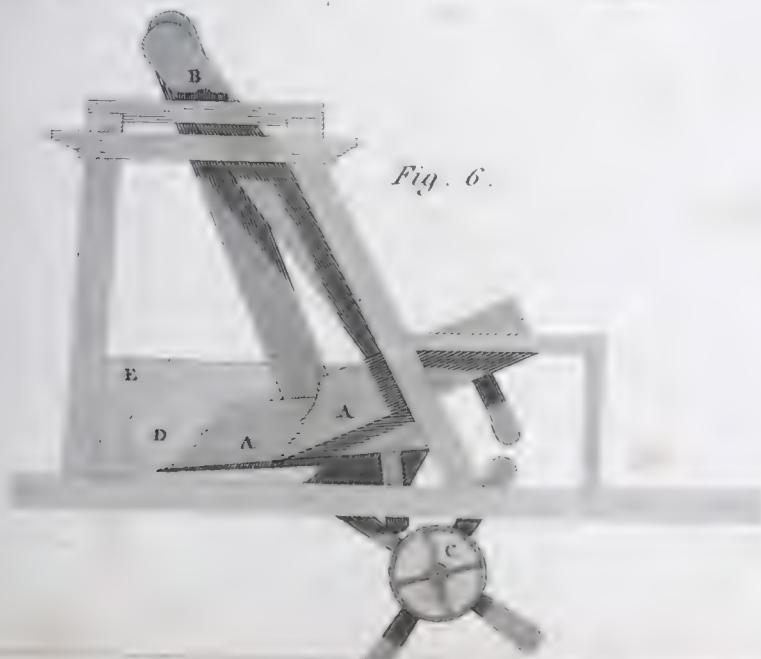


Fig. 7.



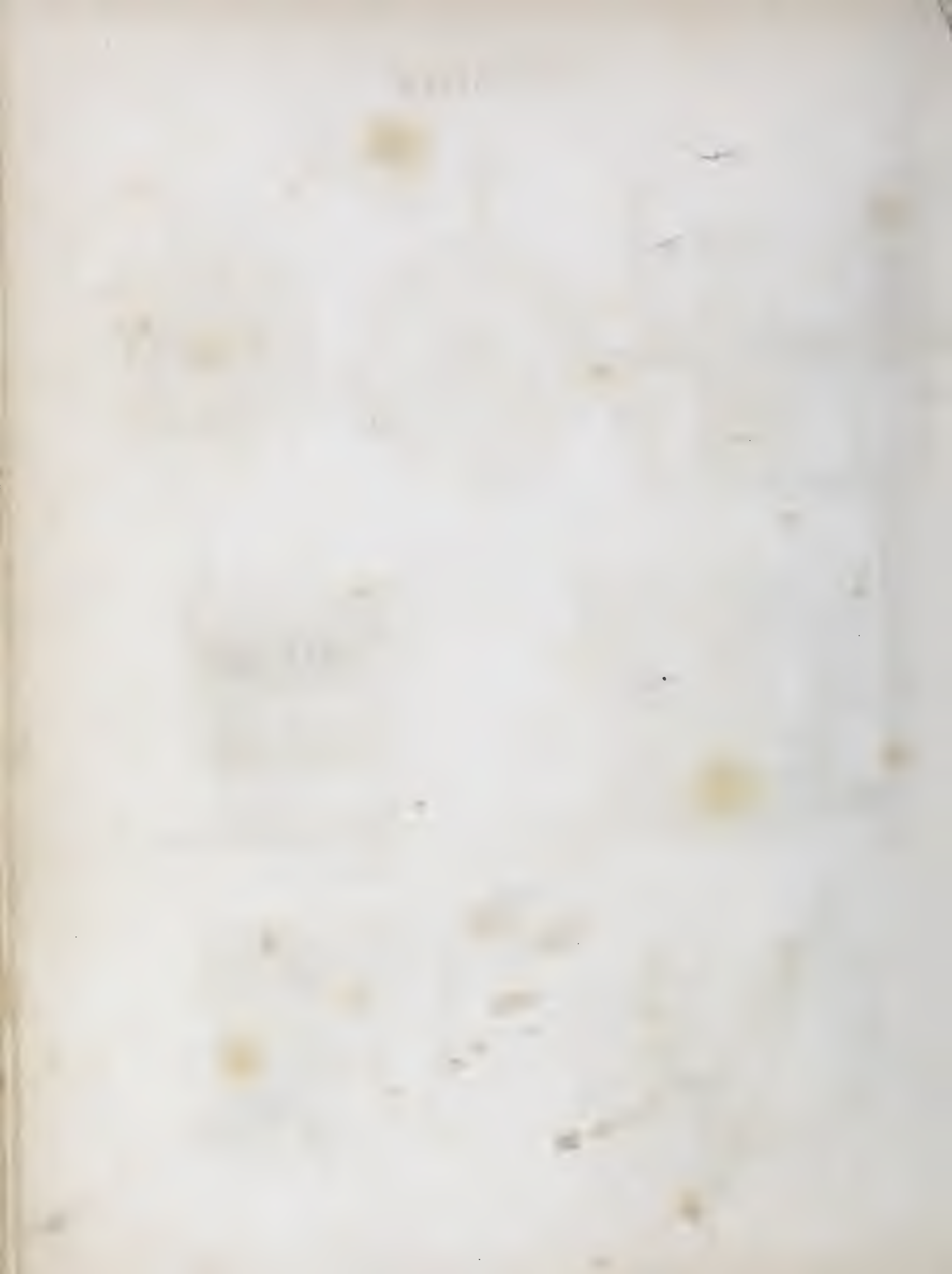


Fig. 1.

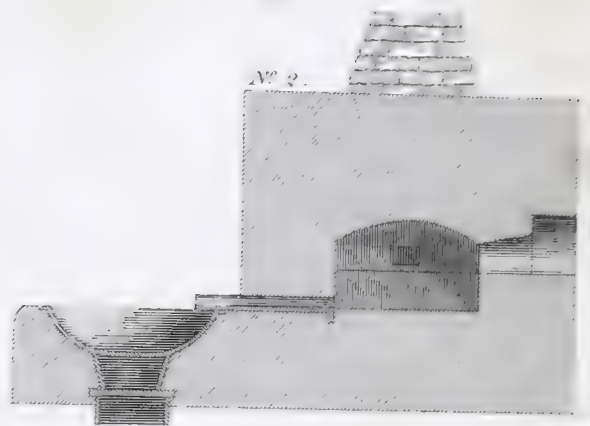
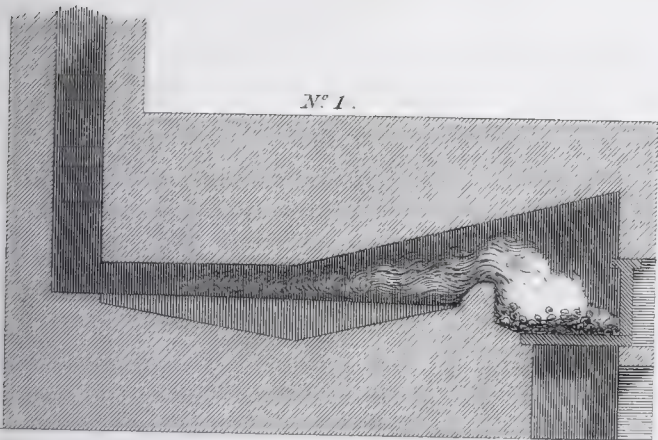


Fig. 2.

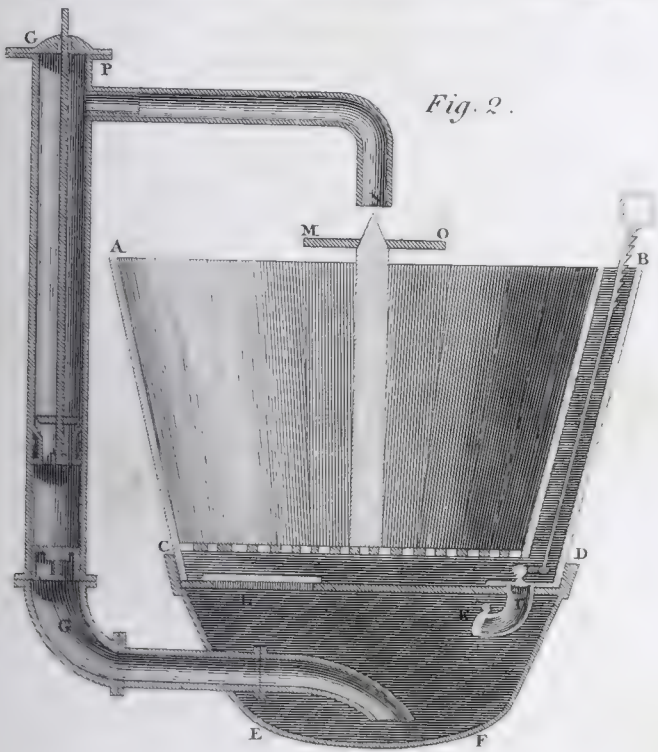


Fig. 3.

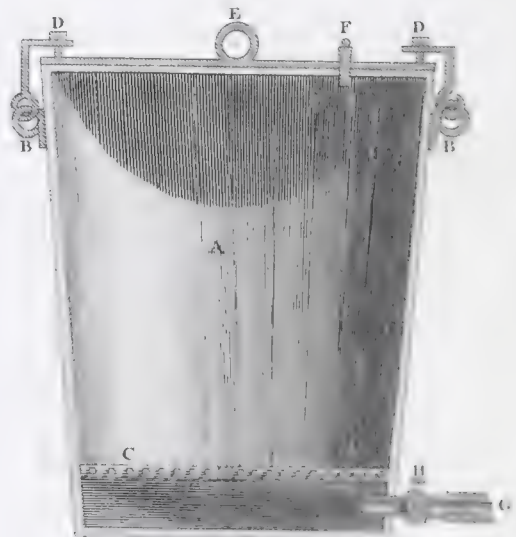


Fig. 4.

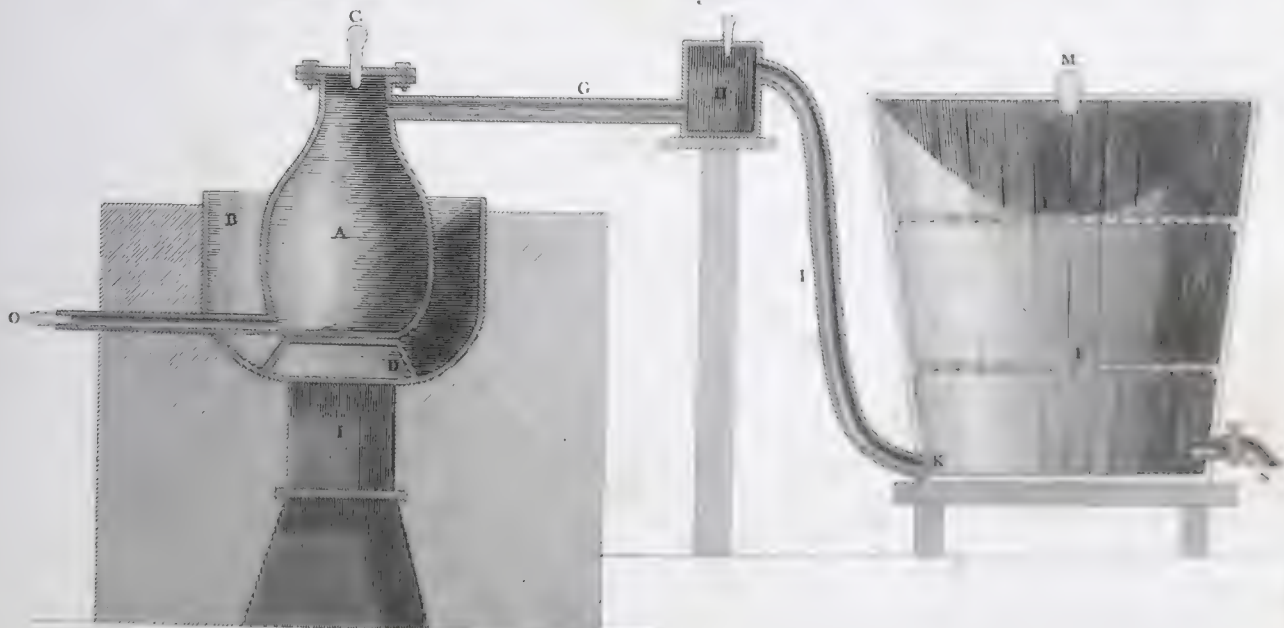






Fig. 4.



Fig. 5.



Fig. 2.

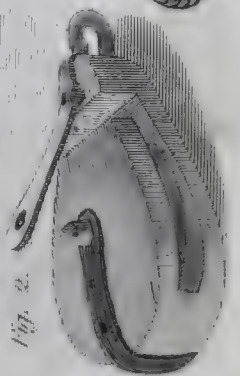


Fig. 3.

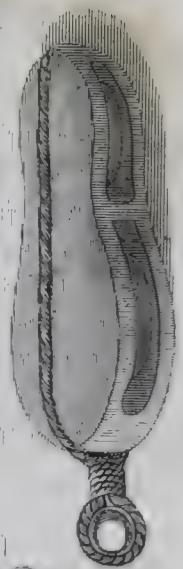


Fig. 1.





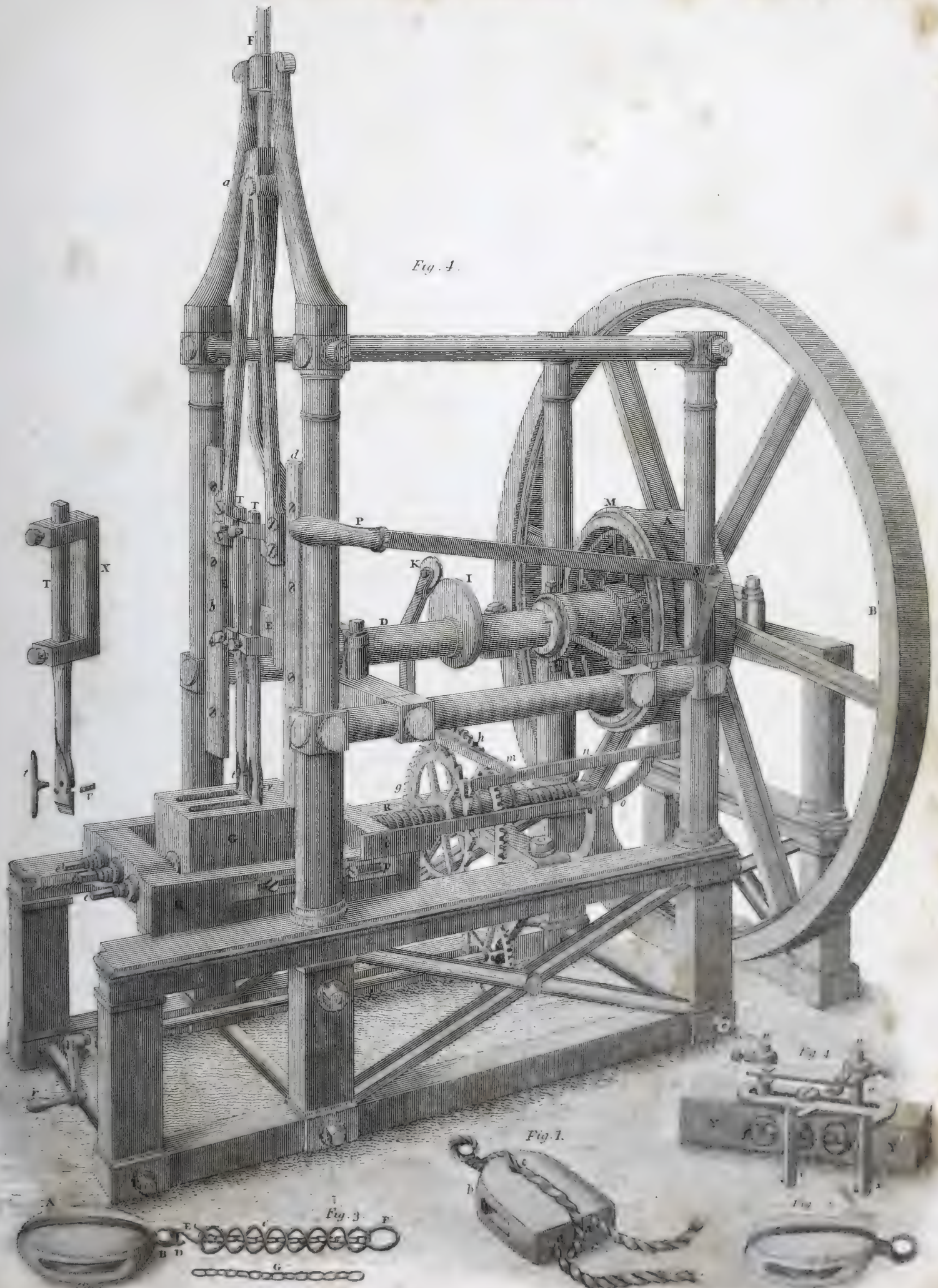


Fig. 1.

Fig. 1.

Fig. 3.

Fig. 4.



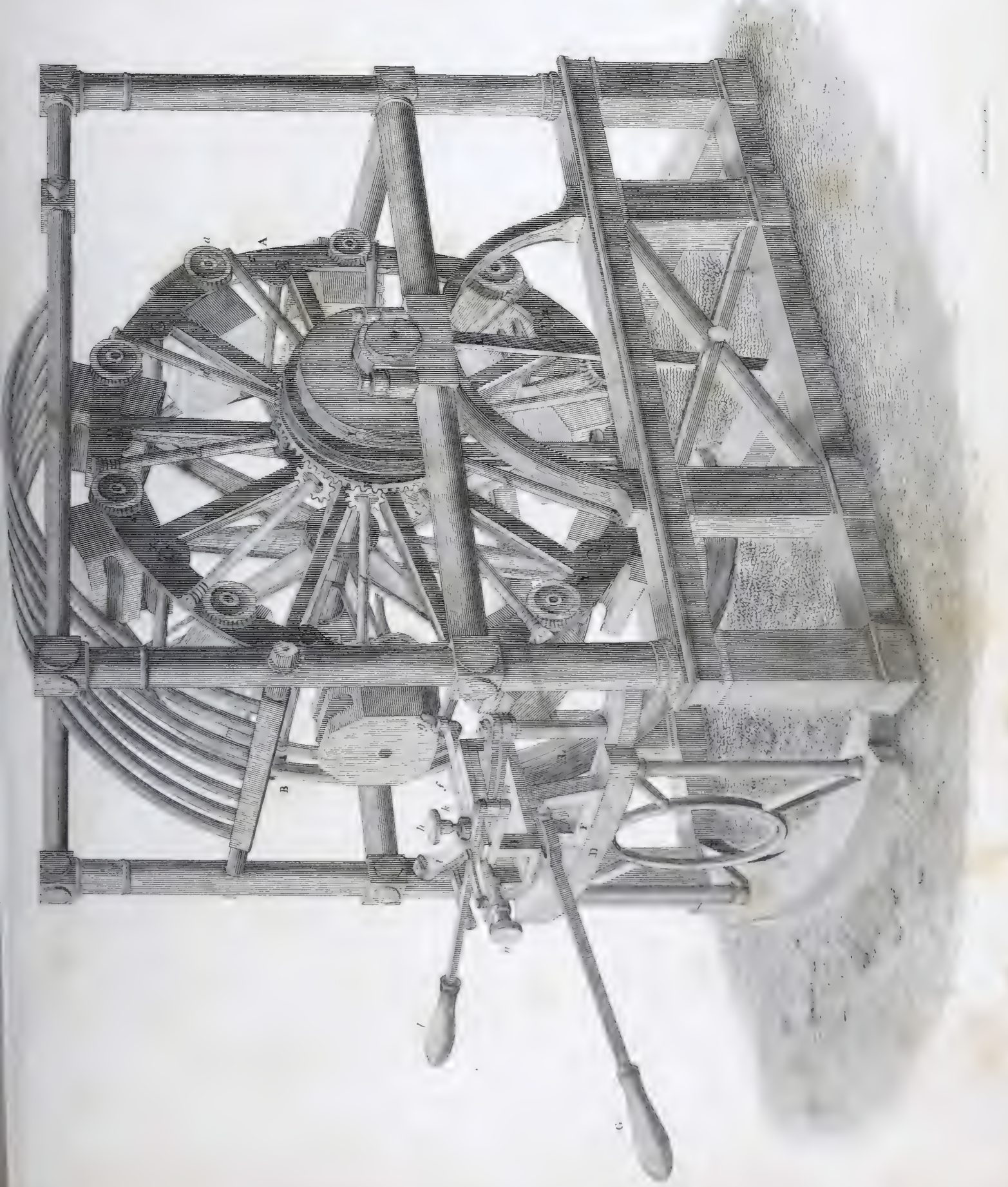




Fig. 1

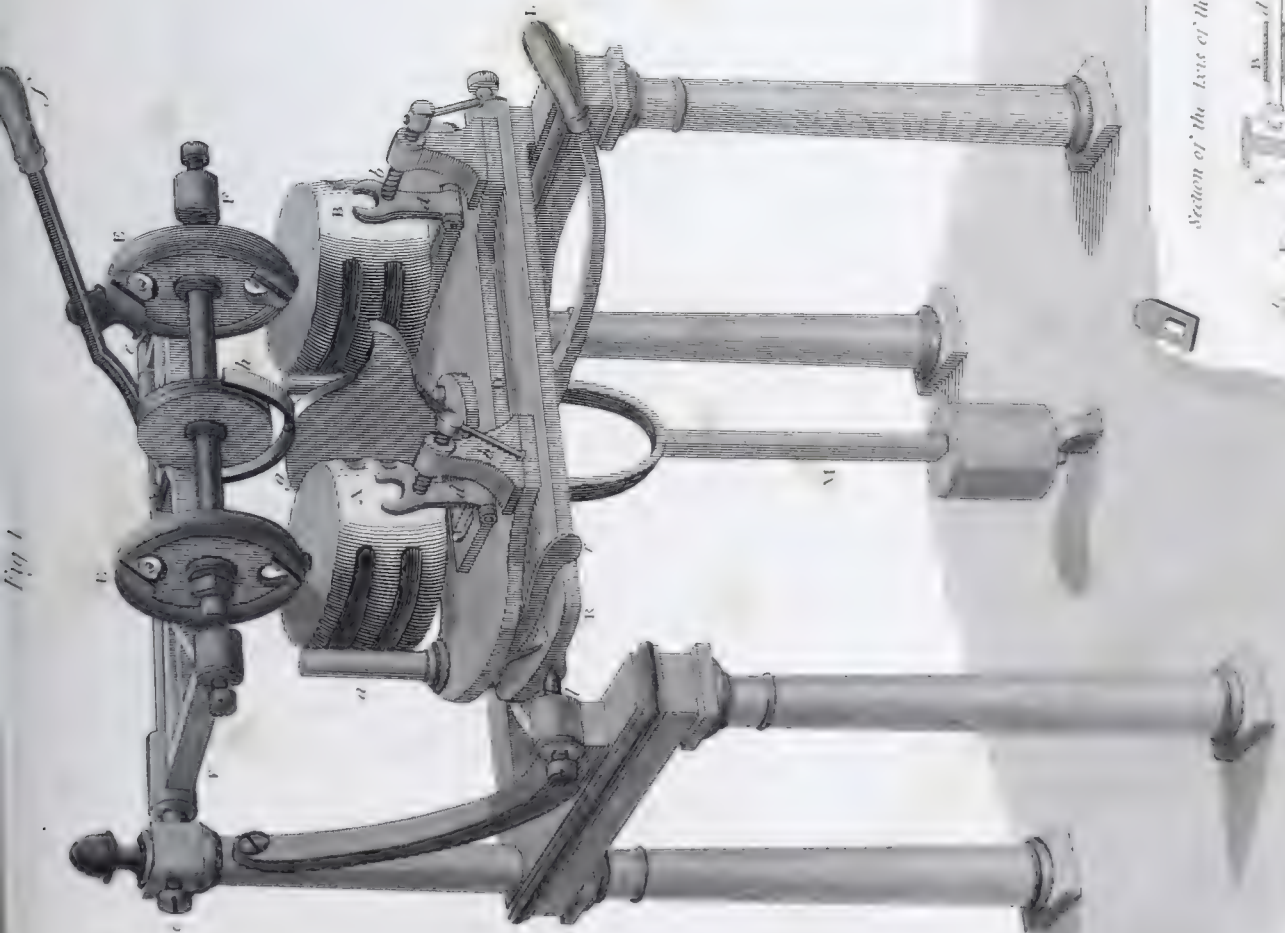
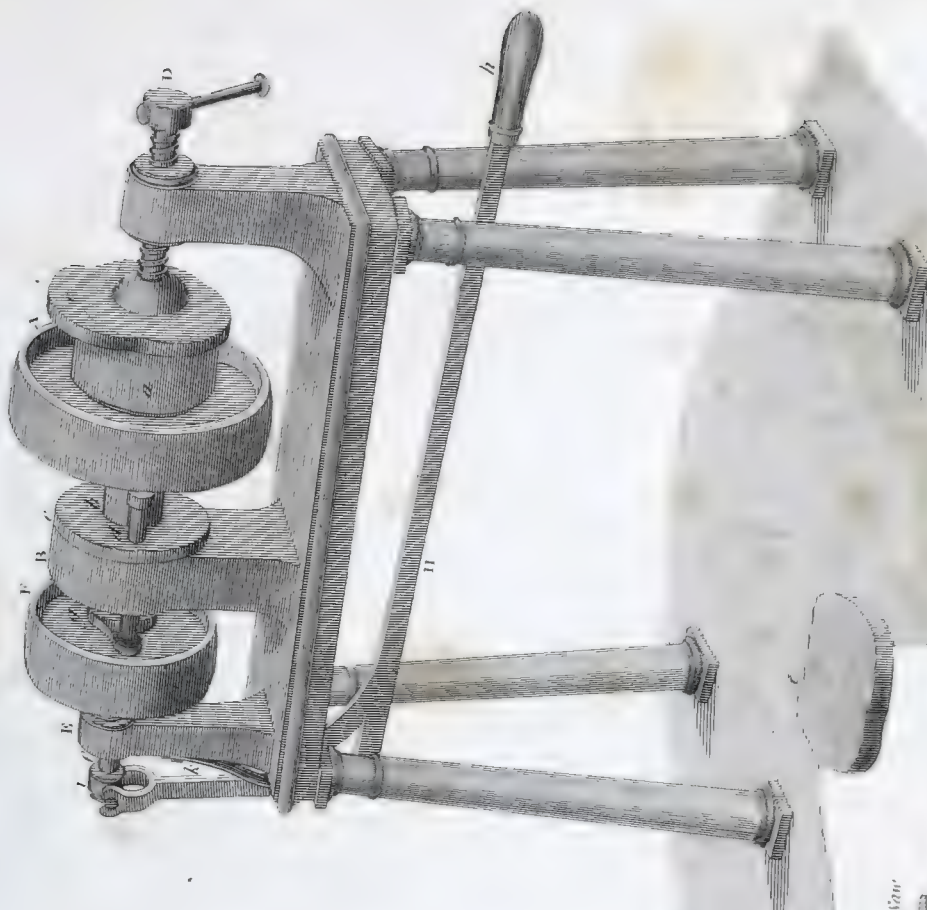


Fig. 2.



Section of the Axis of the Crown Saw







Fig. 1.

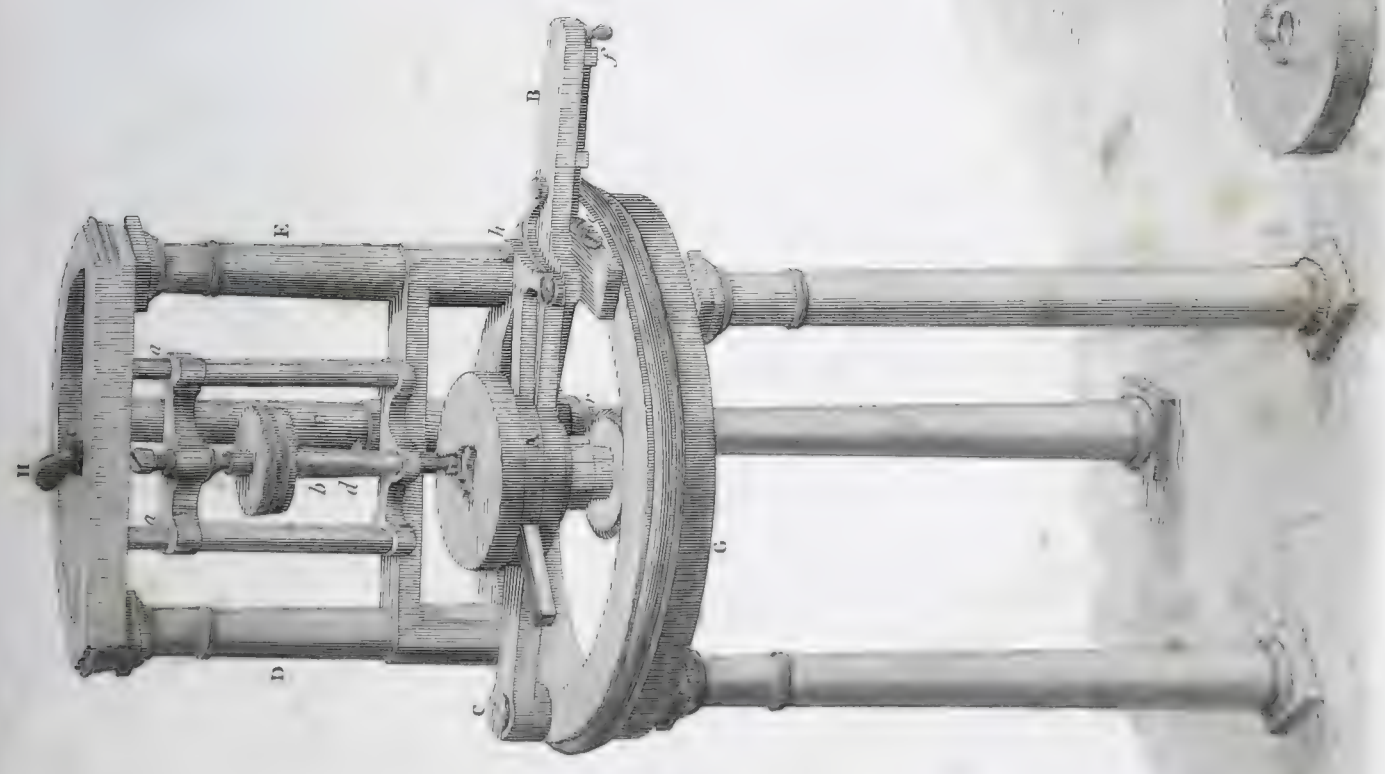
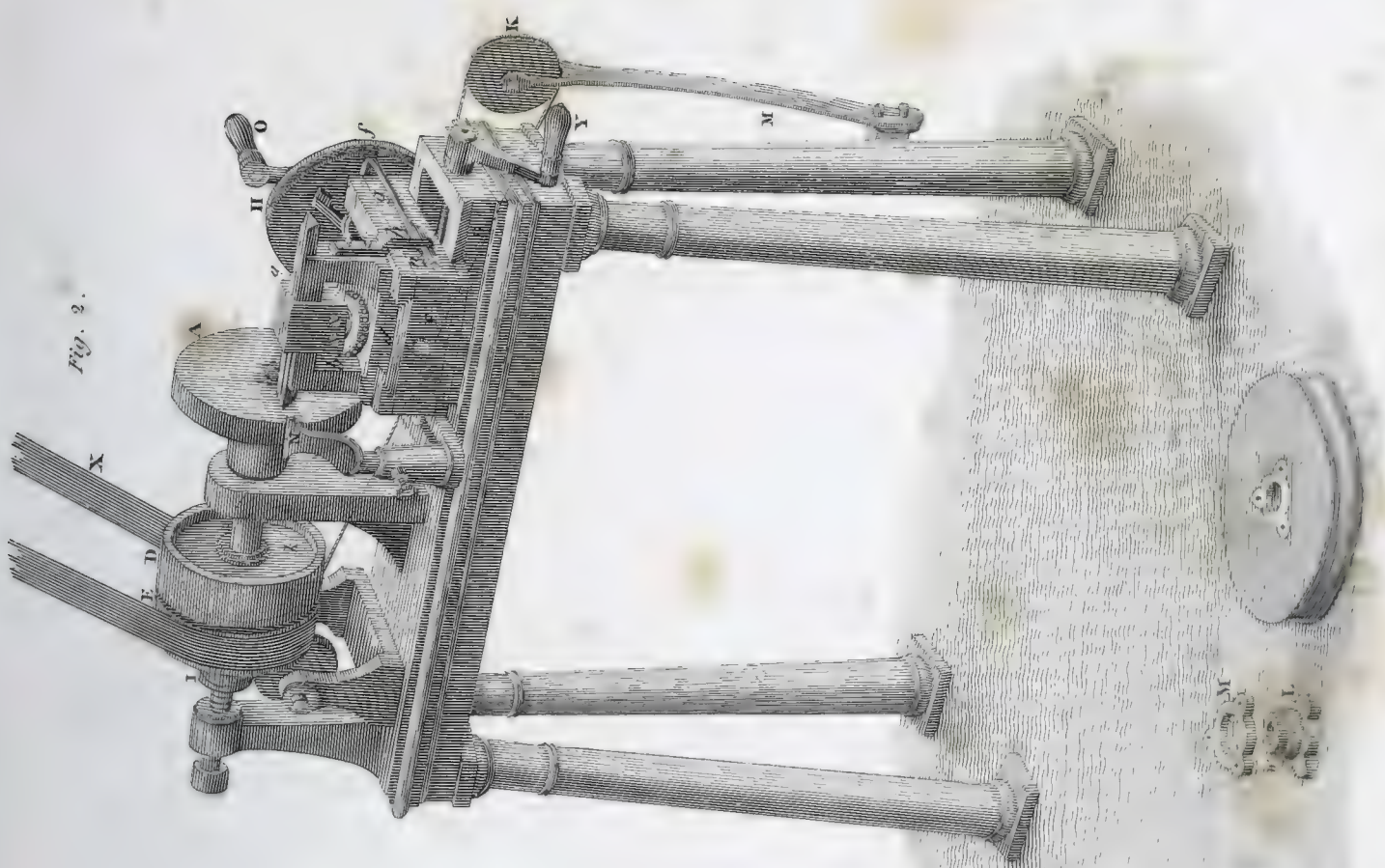


Fig. 2.





BLOW-PIPE.

Fig. 1.

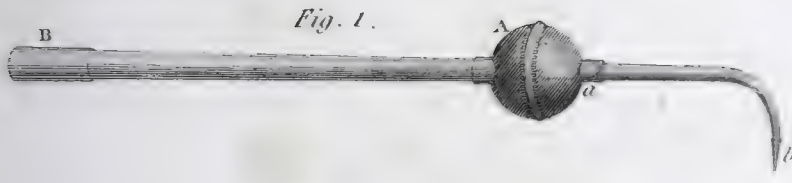


Fig. 2.

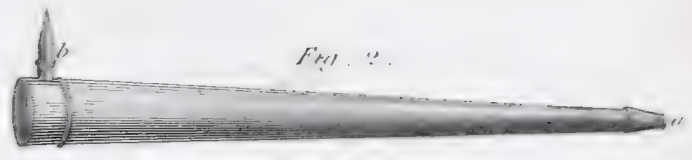


Fig. 3.

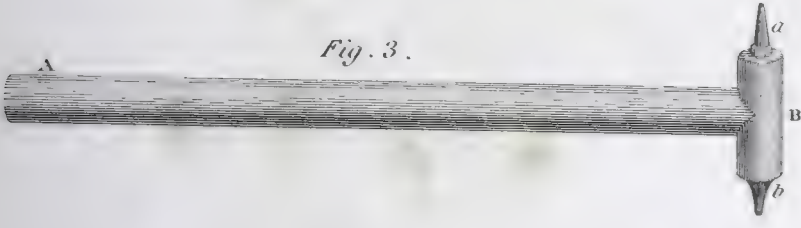


Fig. 4.

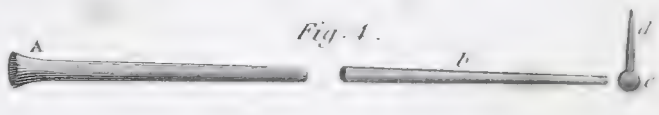


Fig. 5.

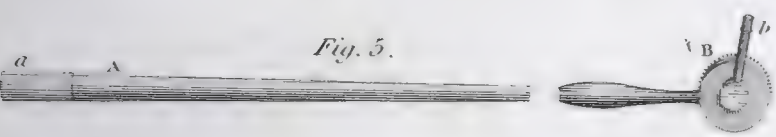


Fig. 6.

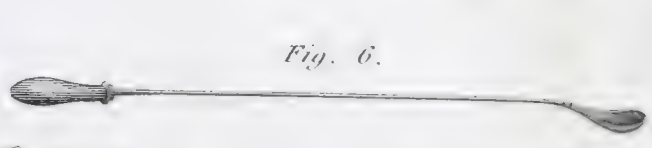


Fig. 7.

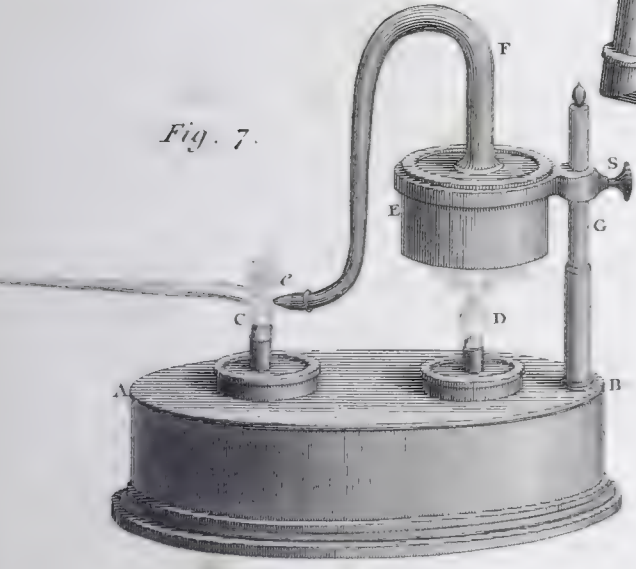


Fig. 10.

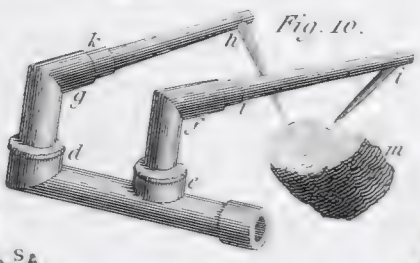


Fig. 8.



Fig. 9.

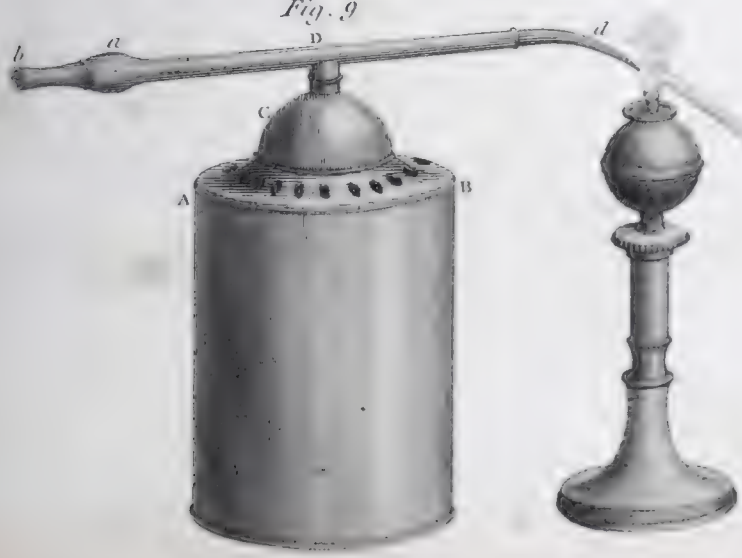


Fig. 11.



Fig. 11

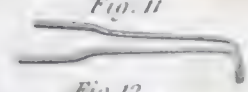


Fig. 12.



Fig. 13





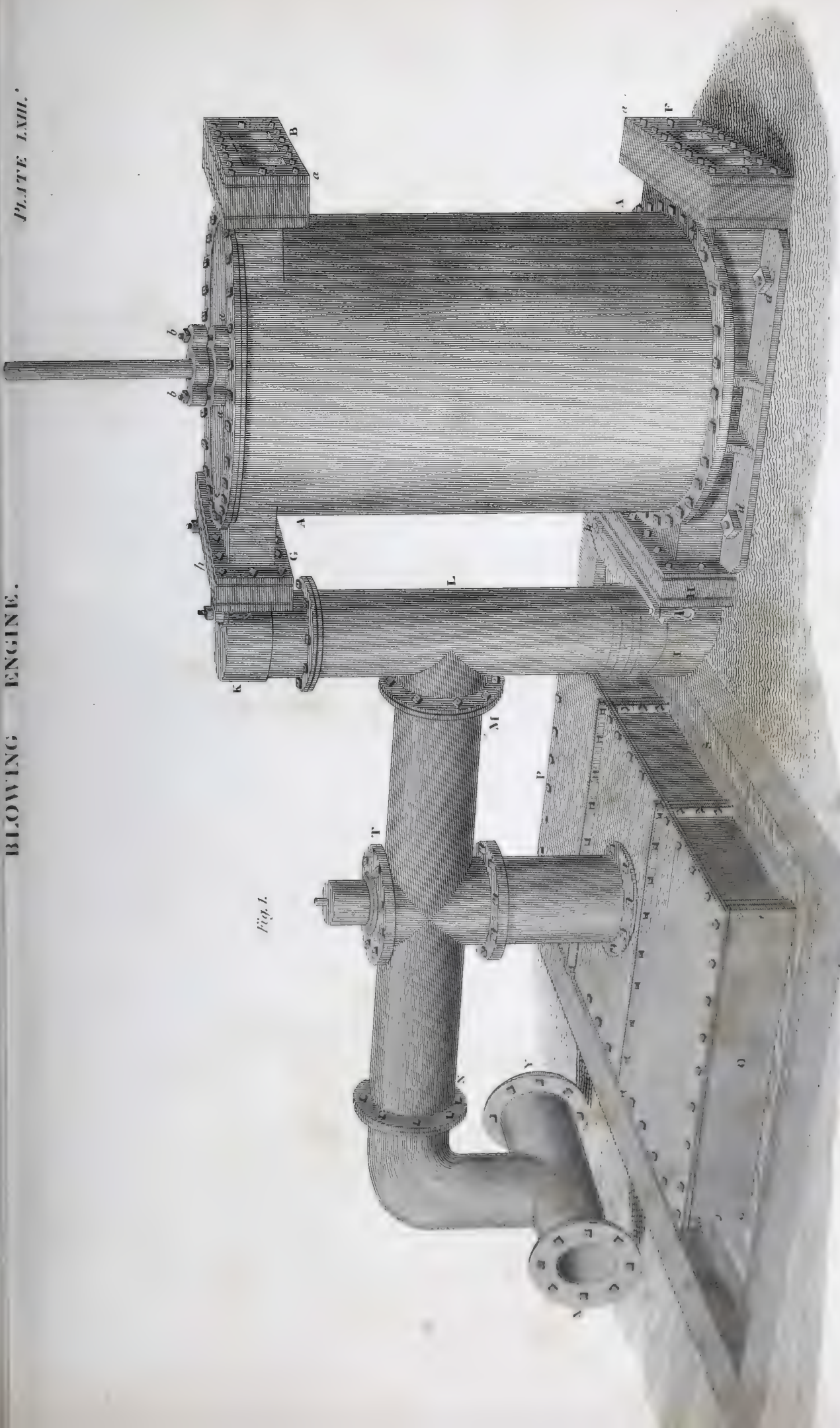


Fig. 1.

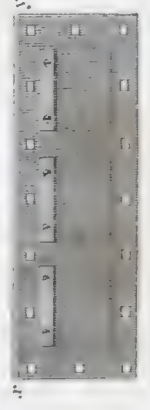


Fig. 2.



# BORING MACHINE.

PLATE LXIV

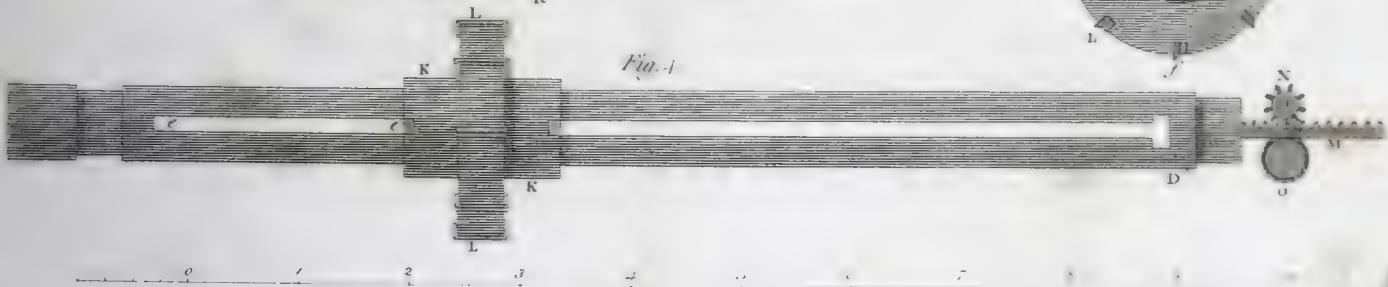
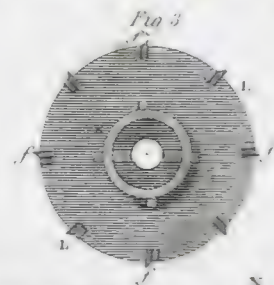
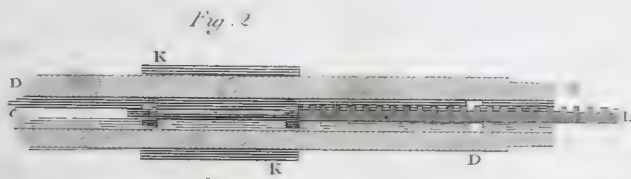
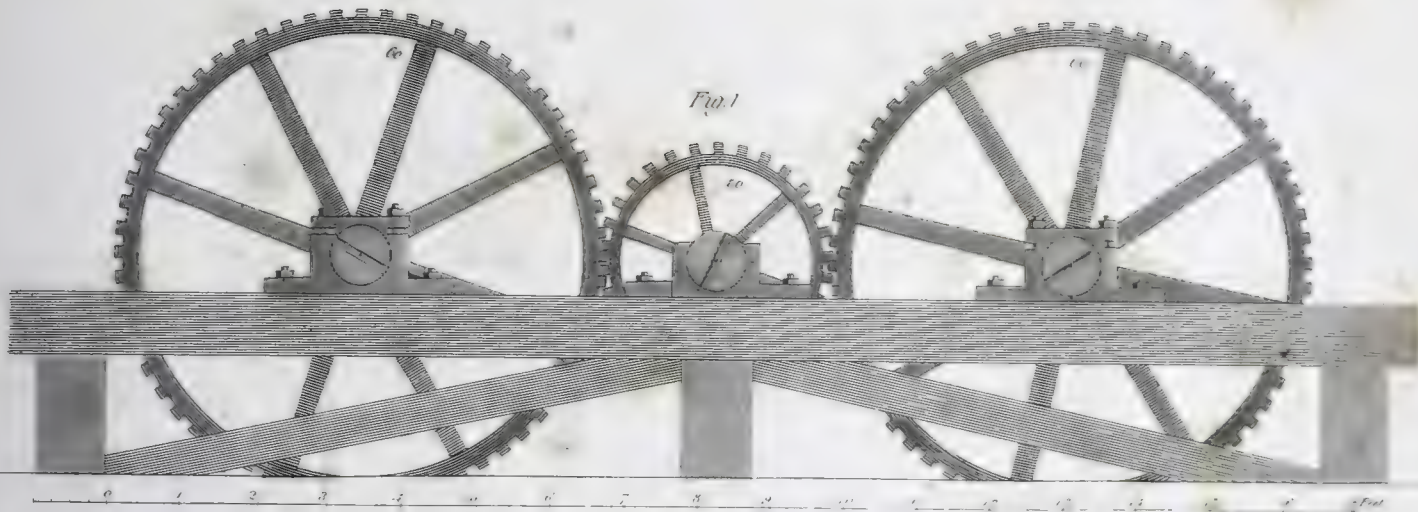
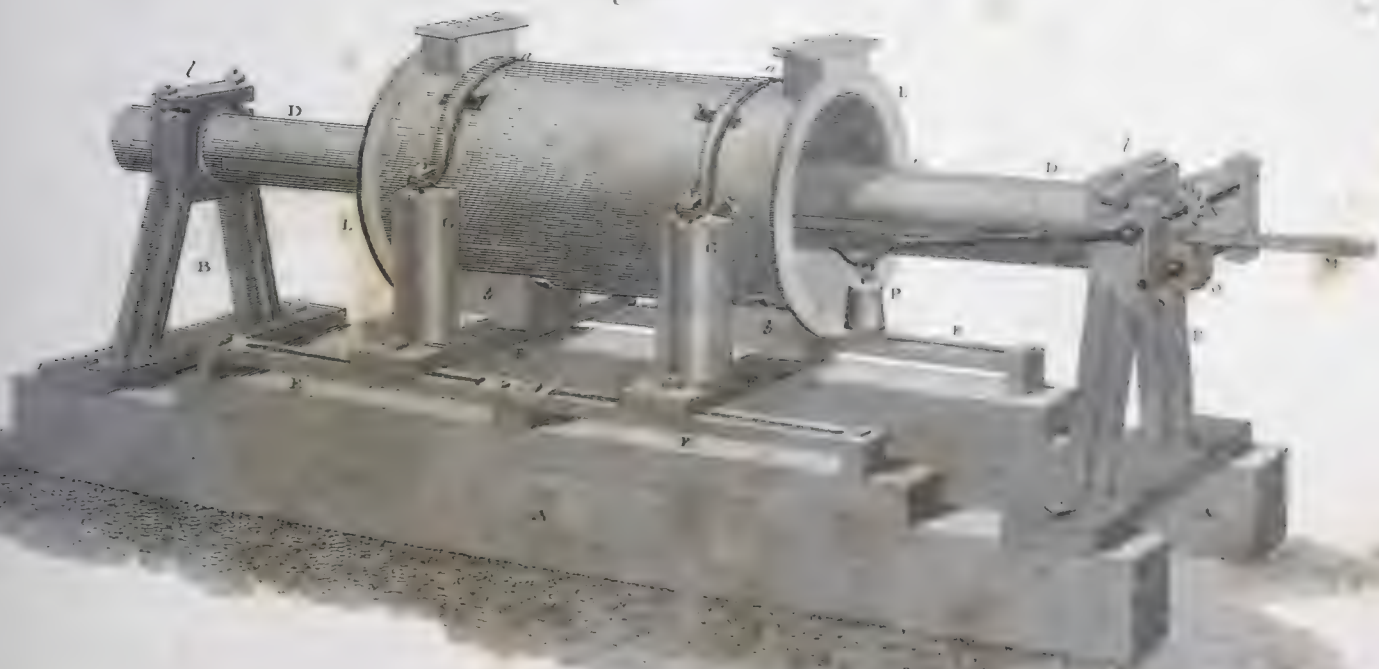
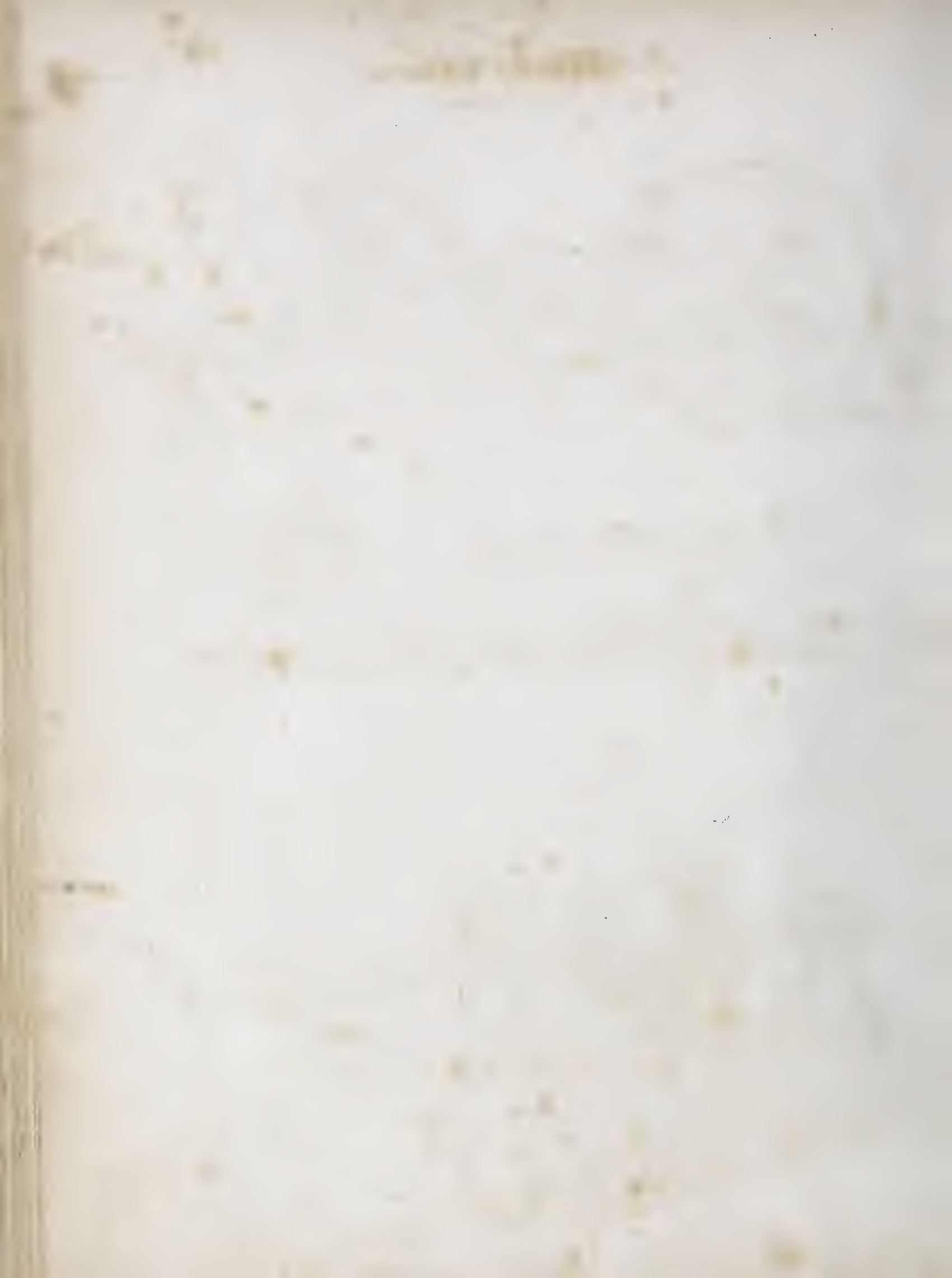


Fig. 5







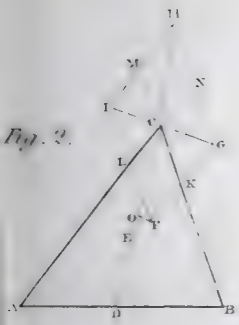


Fig. 1



Fig. 3.

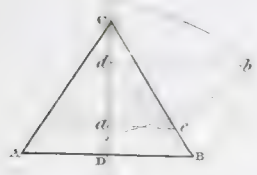


Fig. 4.



Fig. 5

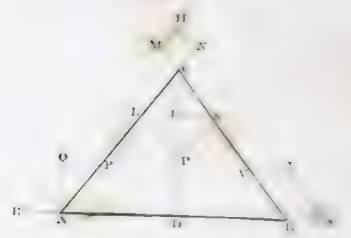


Fig. 7.

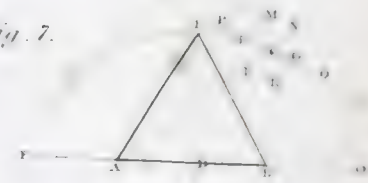


Fig. 8

Fig. 9.

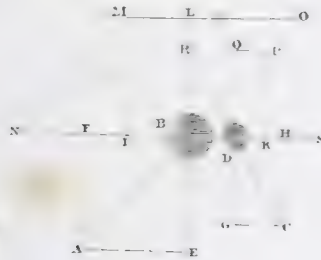


Fig. 9.

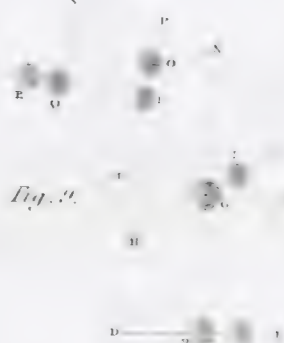


Fig. 10

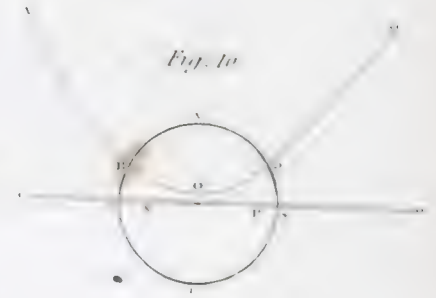


Fig. 11.

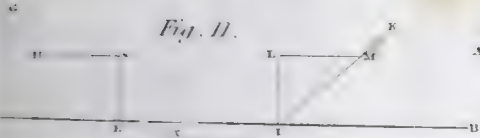


Fig. 12.



Fig. 13

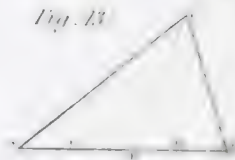


Fig. 14.



Fig. 15.

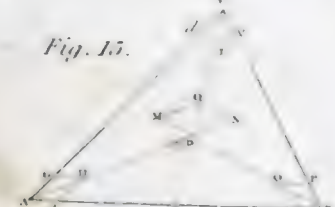


Fig. 17



Fig. 16.

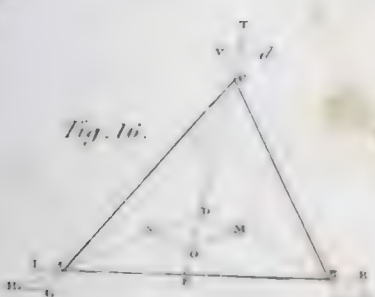


Fig. 19.

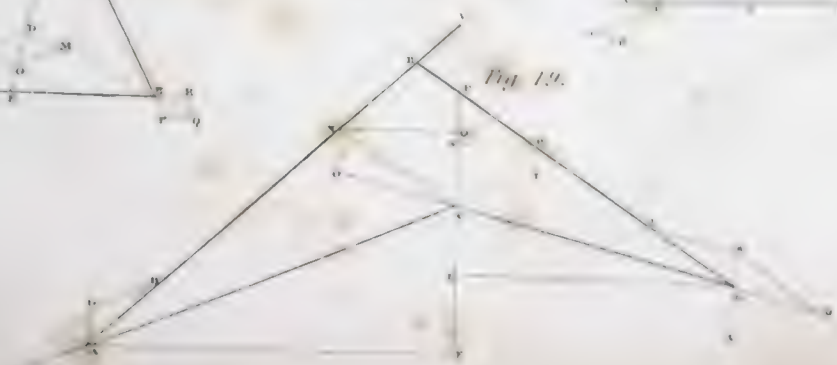
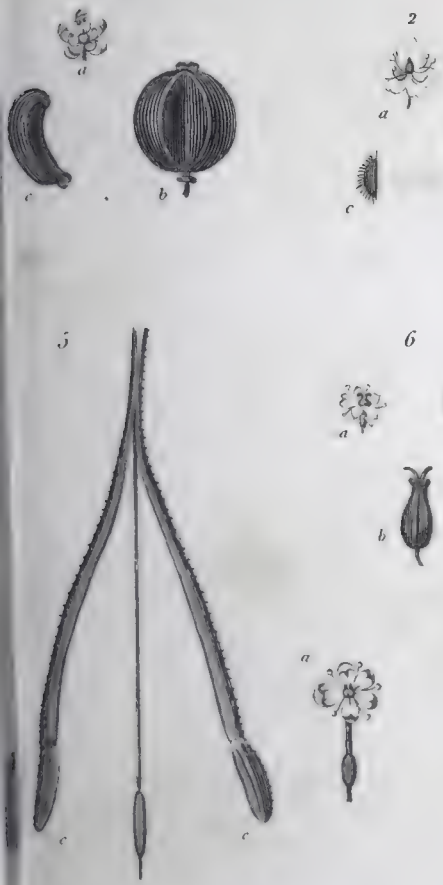


Fig. 20





Fig. 1.



Class VII. UMBELLATE.



Class VIII. CARYOPHYLLOUS.

Fig. 1.



Class IX. LILLACEOUS.

Fig. 1.



























Fig. 1.

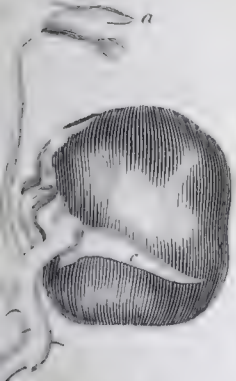


Fig. 2.

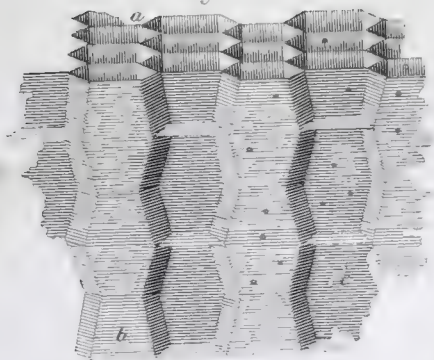


Fig. 3.



Fig. 4.



Fig. 5.

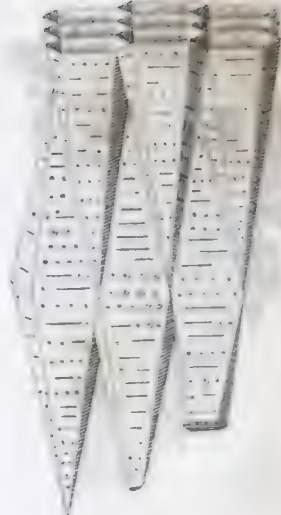


Fig. 6.

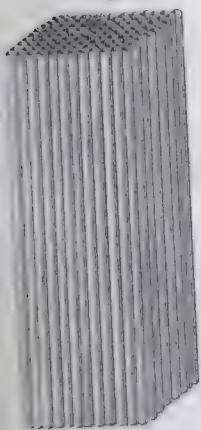


Fig. 7.



Fig. 8.



Fig. 9.

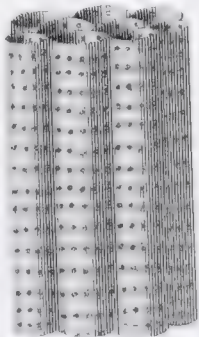


Fig. 10.

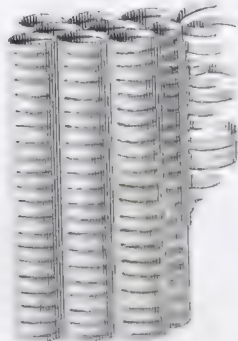


Fig. 12.

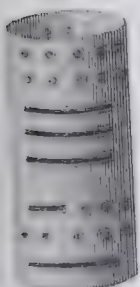


Fig. 13.



Fig. 14.



Fig. 15.

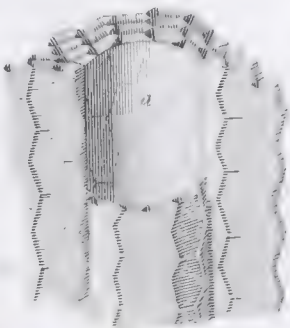


Fig. 16.



Fig. 18.



Fig. 22.

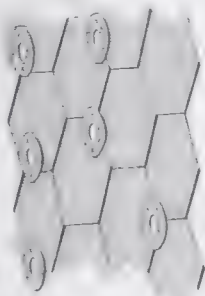


Fig. 21.

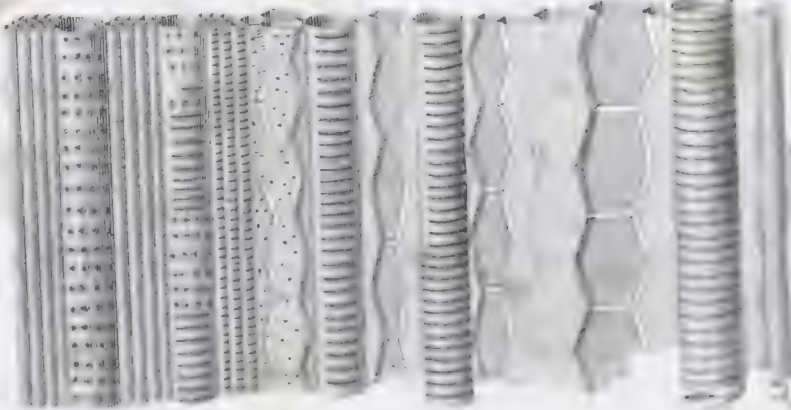


Fig. 19.

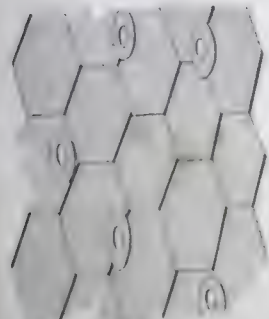
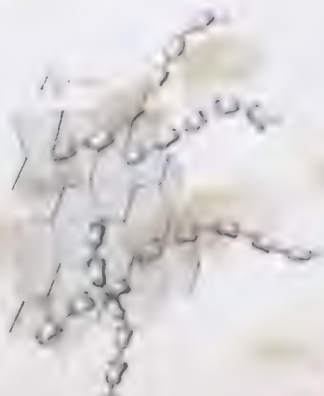
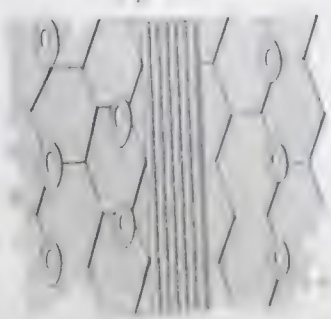
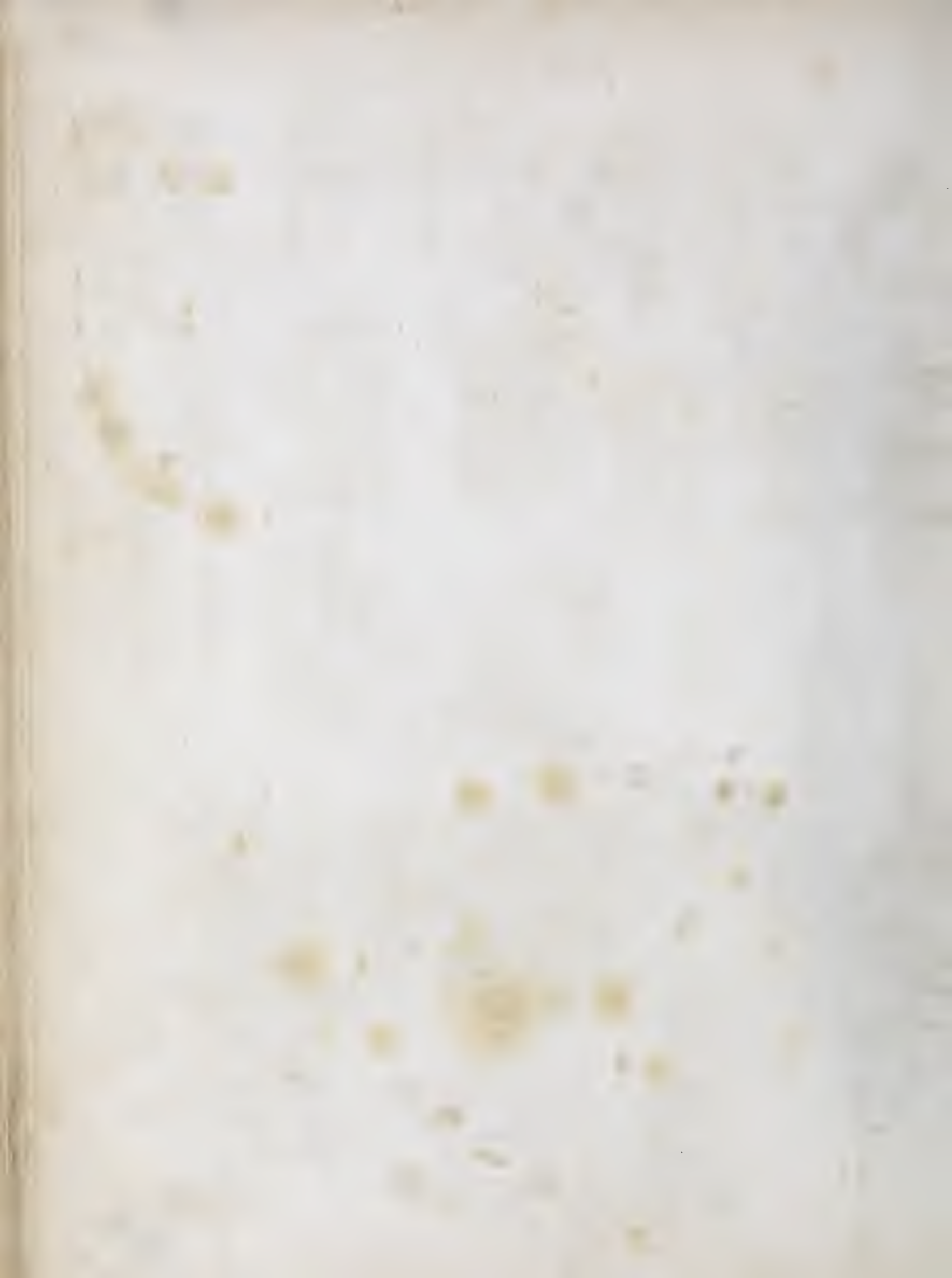


Fig. 20.







BOTANY.

MONANDRIA.



HEPTANDRIA.



ENNEANDRIA.



OCTANDRIA.



PENTANDRIA.

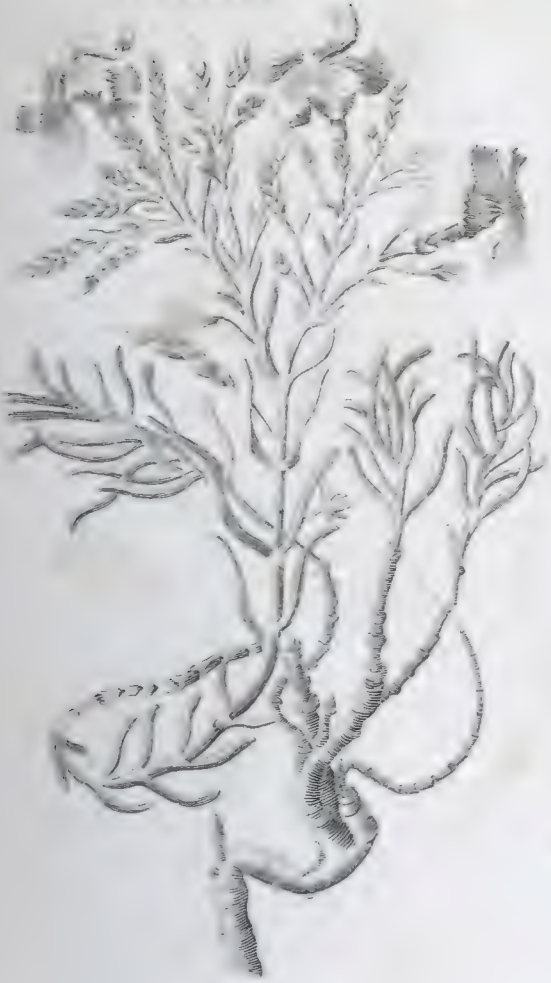


HEXANDRIA.





DECANDRIA



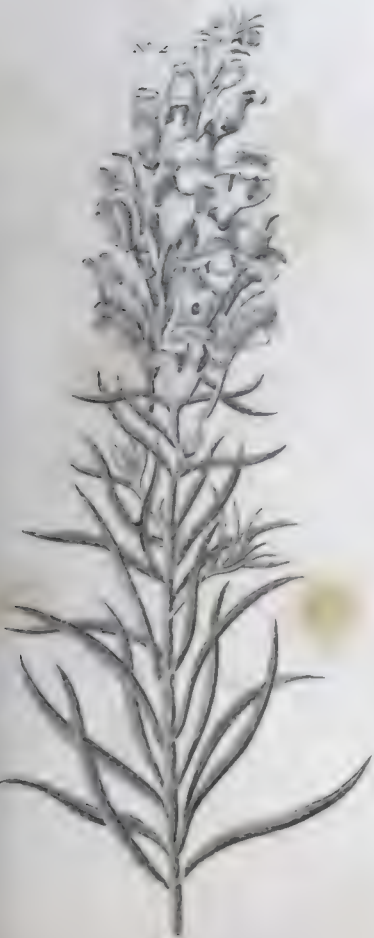
ICOSANDRIA



DIDYNAMIA



DIDYNAMIA



POLYANDRIA



TETRADYNAMIA





TETRADYNAMIA.



MONOECIA



SYNGENESIA



DIOECIA.



POLYADELPHIA.



GYNANDRIA





BOTANY.

PLATE LXXV.

Fig. 1. FILICES.

Fig. 2. Musci.

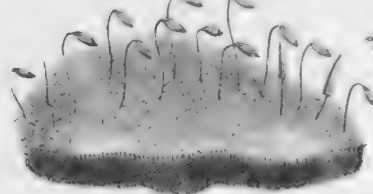
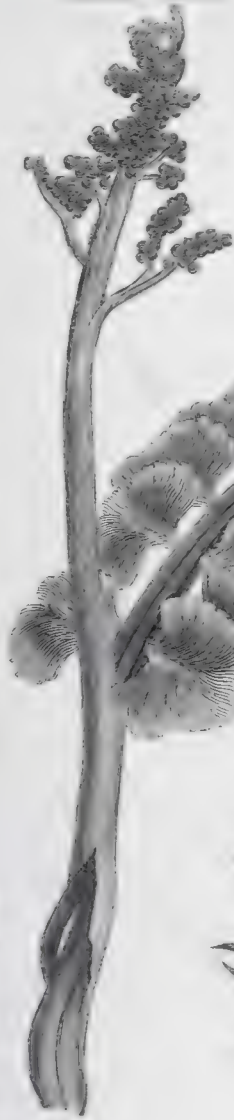
*ADiantum TRICHOMANES.*

*OSMUNDA LUNARIA.*

*BRYUM CESPITITUM.*

*HYPNUM PROLIFERUM.*

*FUNARIA HYGROMETRICUS.*



*MARCHANTIA COSTA.*

Fig. 3. HEPATICÆ.

*JUNGERMANNIA POLYANTHUS.*

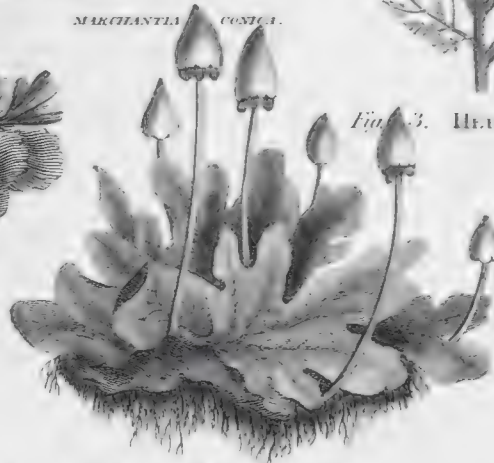


Fig. 4. ALGÆ. (LICHENES.)

*LIChEN KAMPFERIANUS.*



*LIChEN ROCCELLA.*

*LIChEN TARTAREUS.*

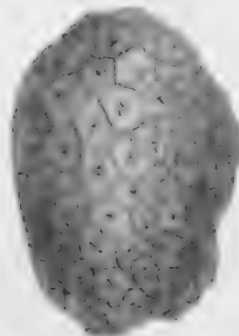
*AGARICUS CAMPESTRIS.*

Fig. 5. FUNGI.

*MORCHELLA ESCULENTA.*



*TURBICLIANIUM*







BRAMAH'S  
BANK NOTE PRESS.

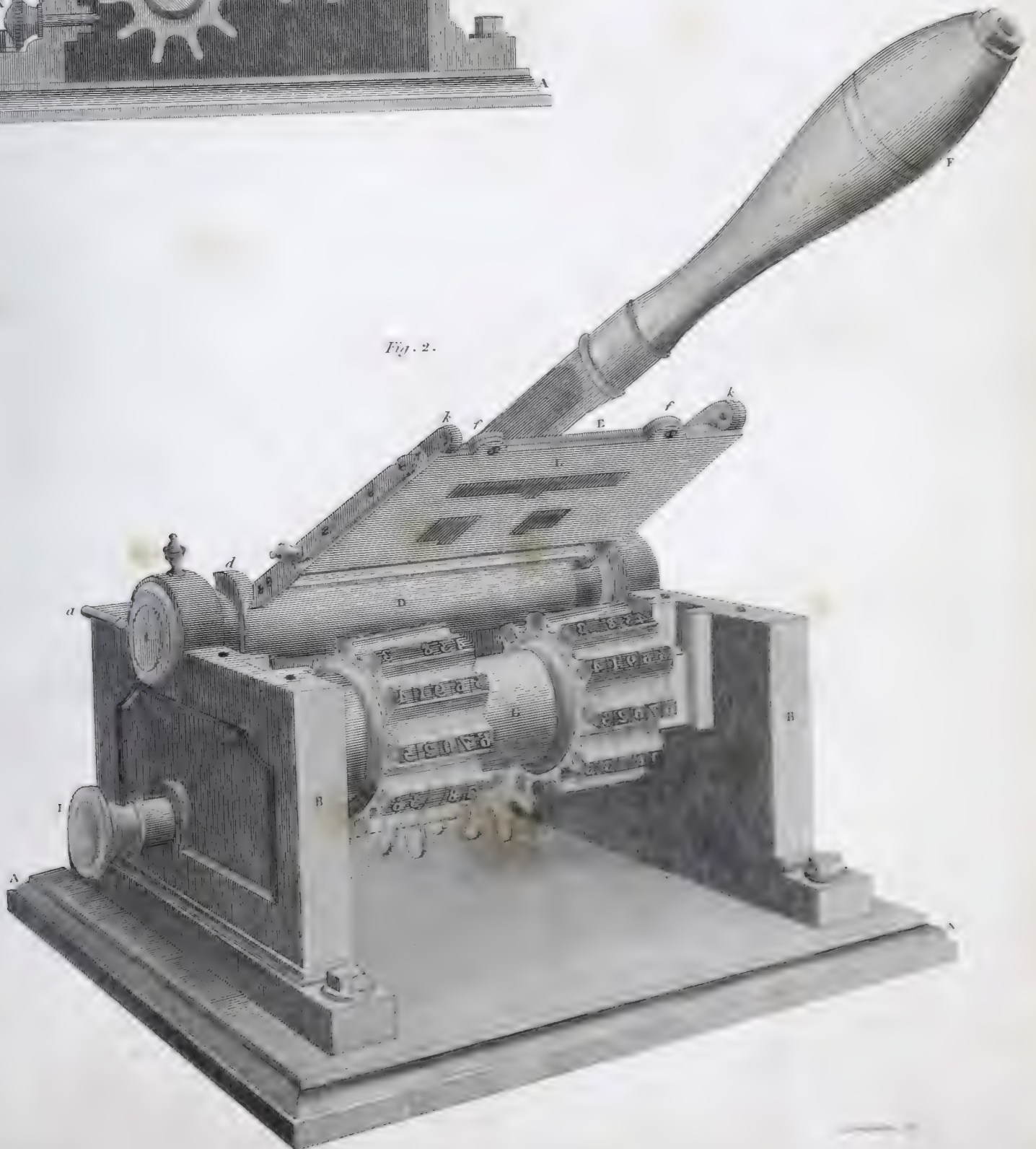
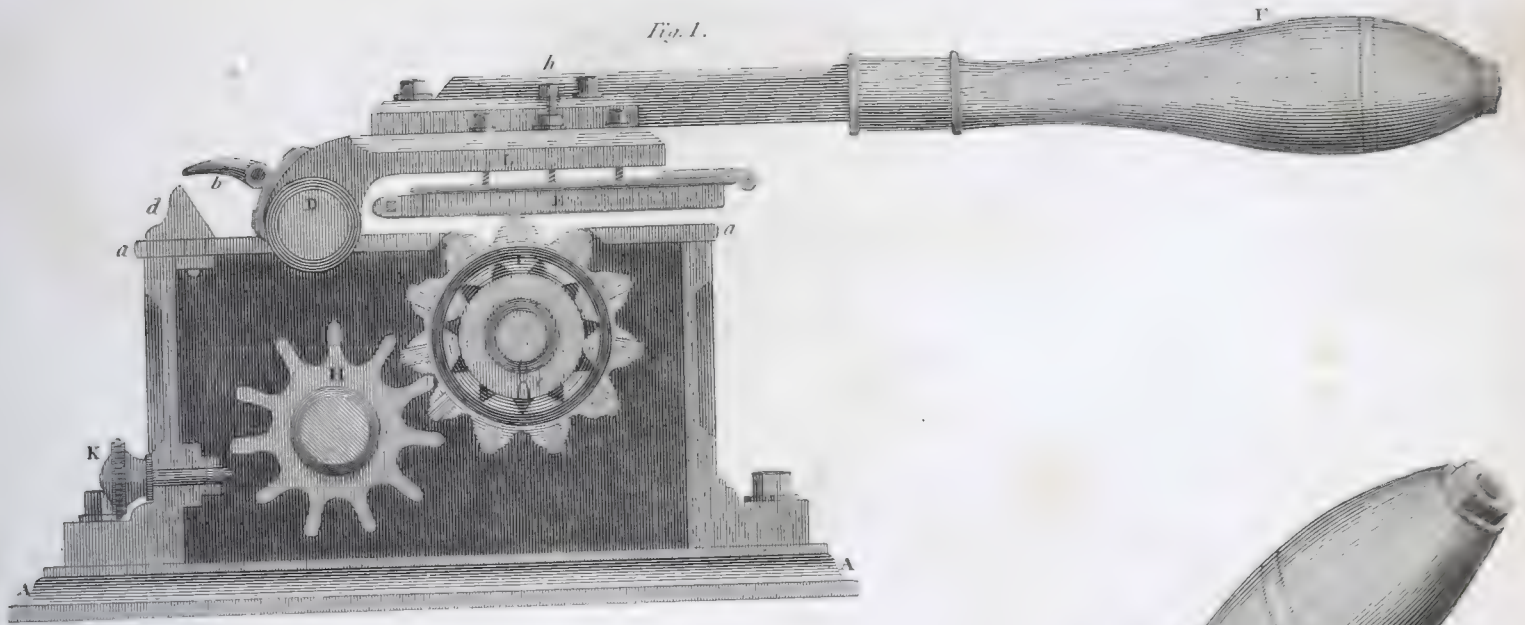
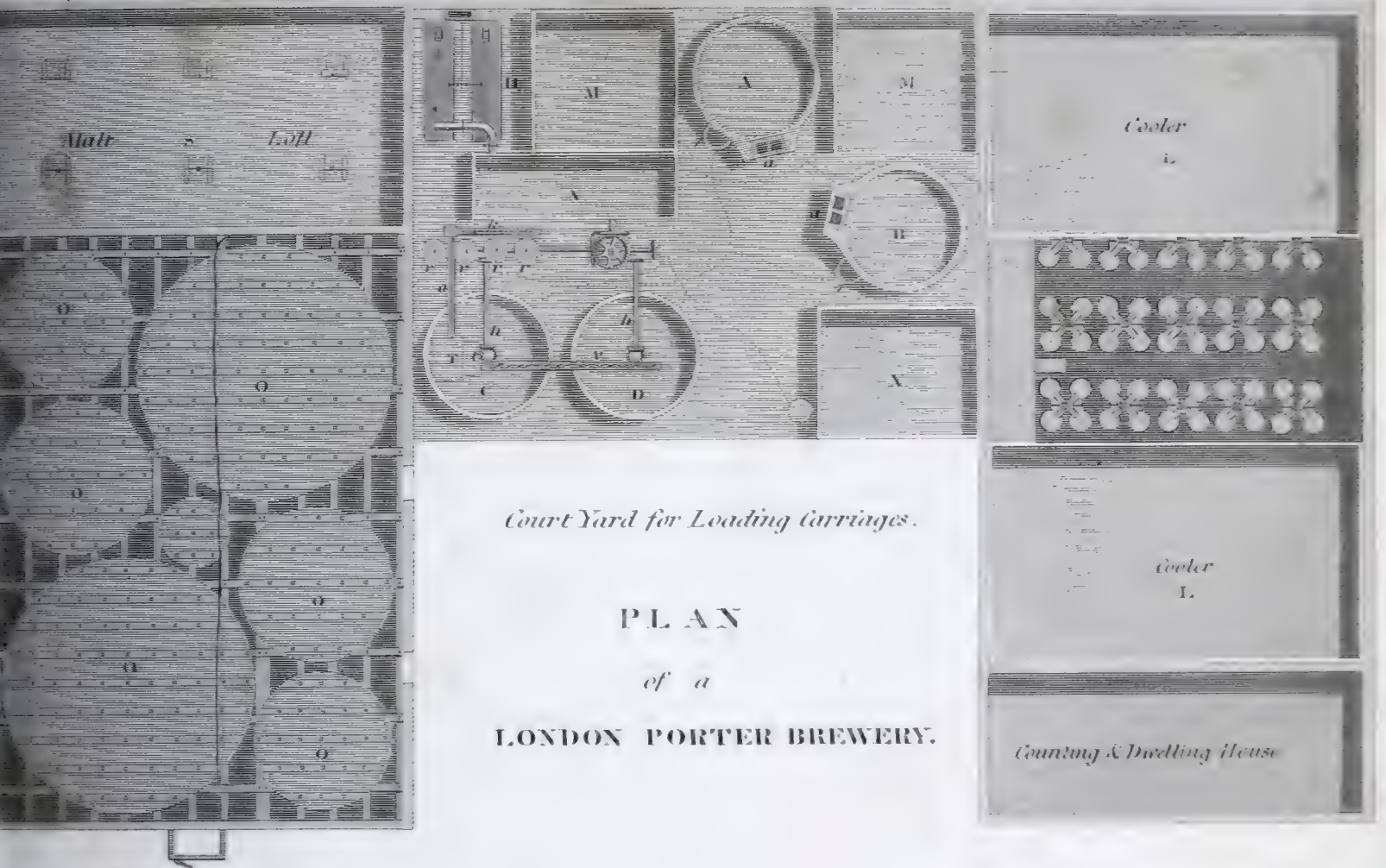
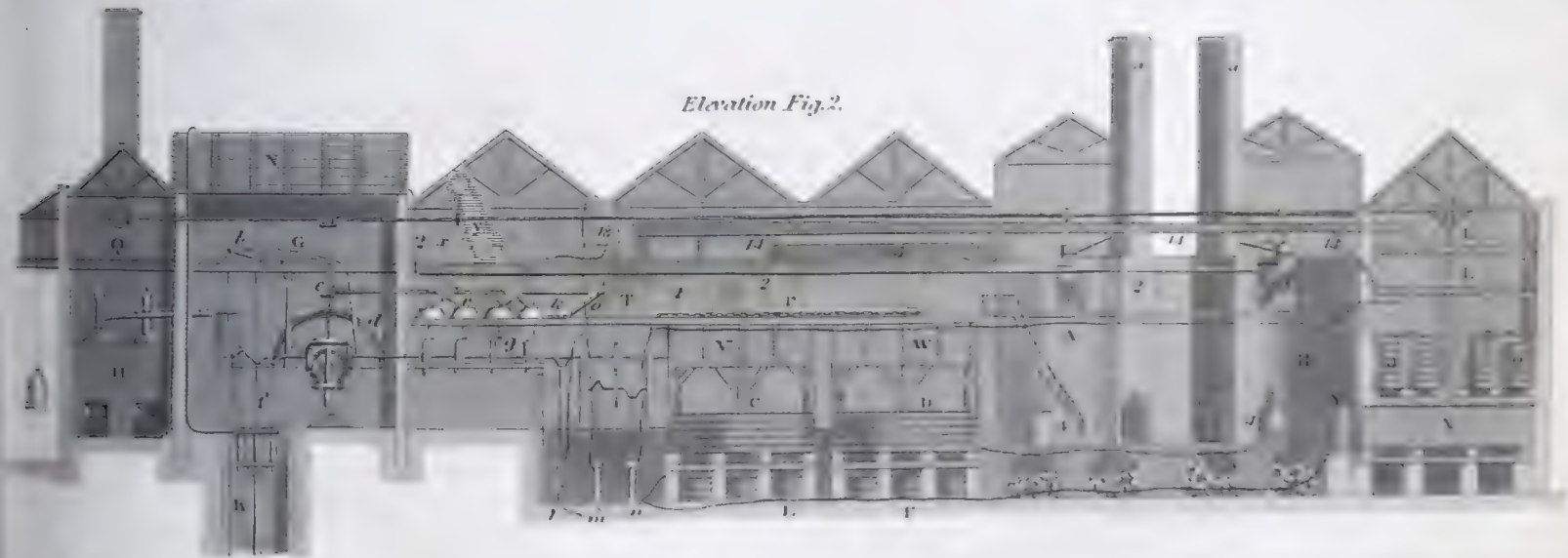




Fig. 1.



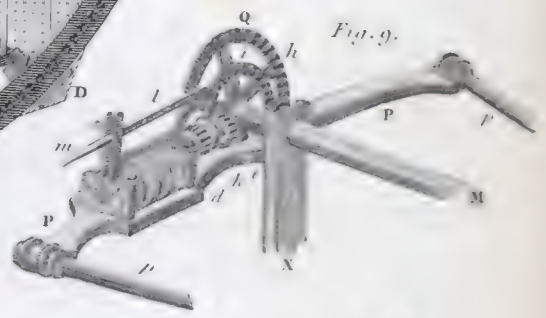
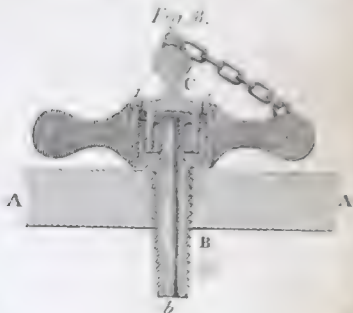
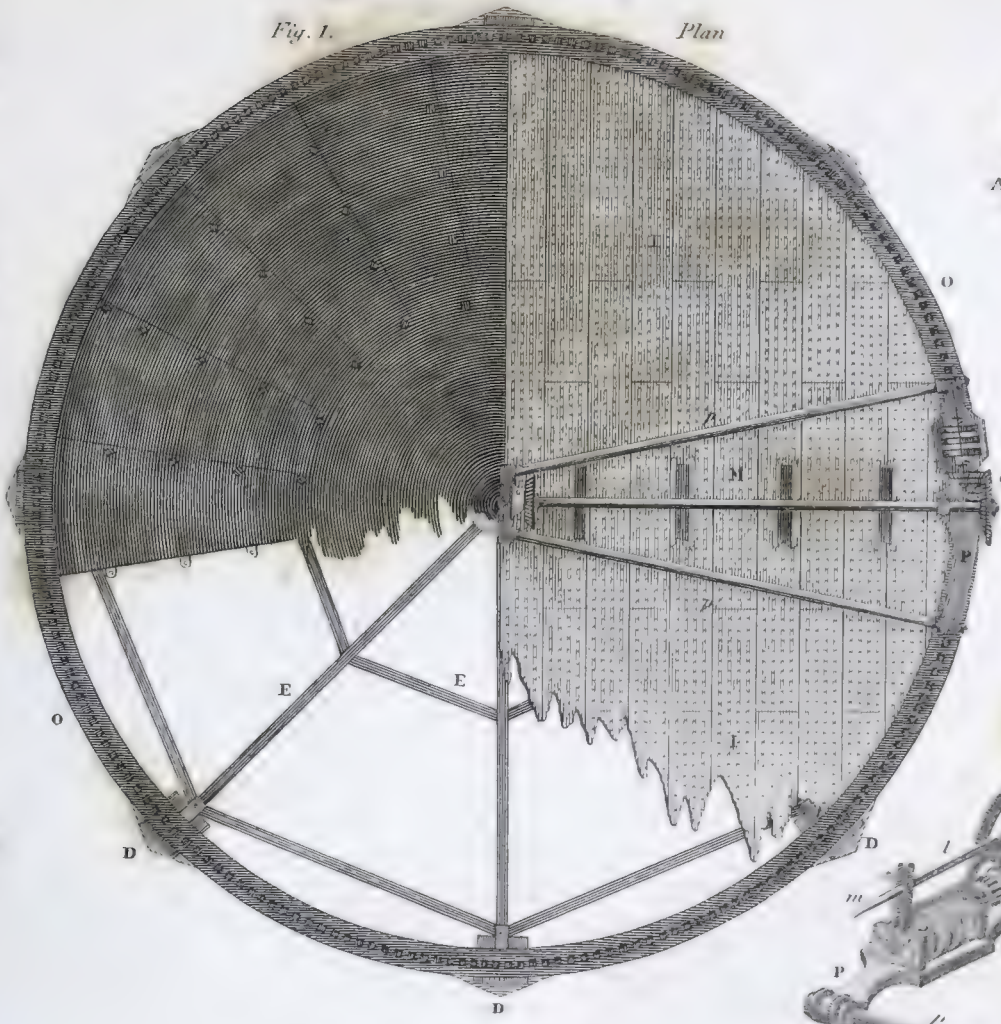
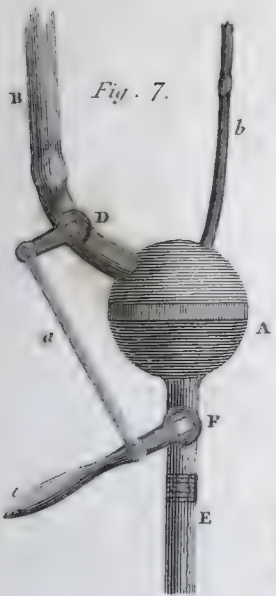
Elevation Fig. 2.



Elevation Fig. 3.







CAST IRON MASH TUN.

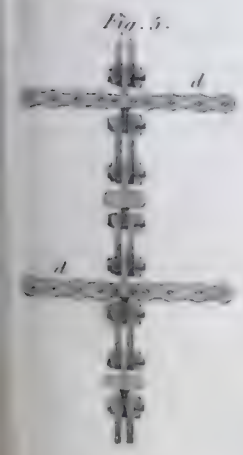
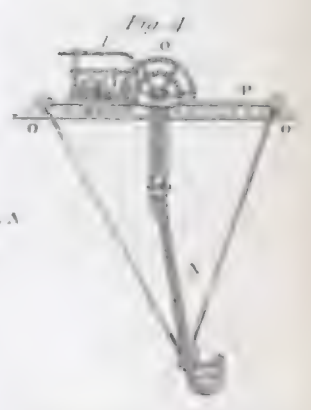
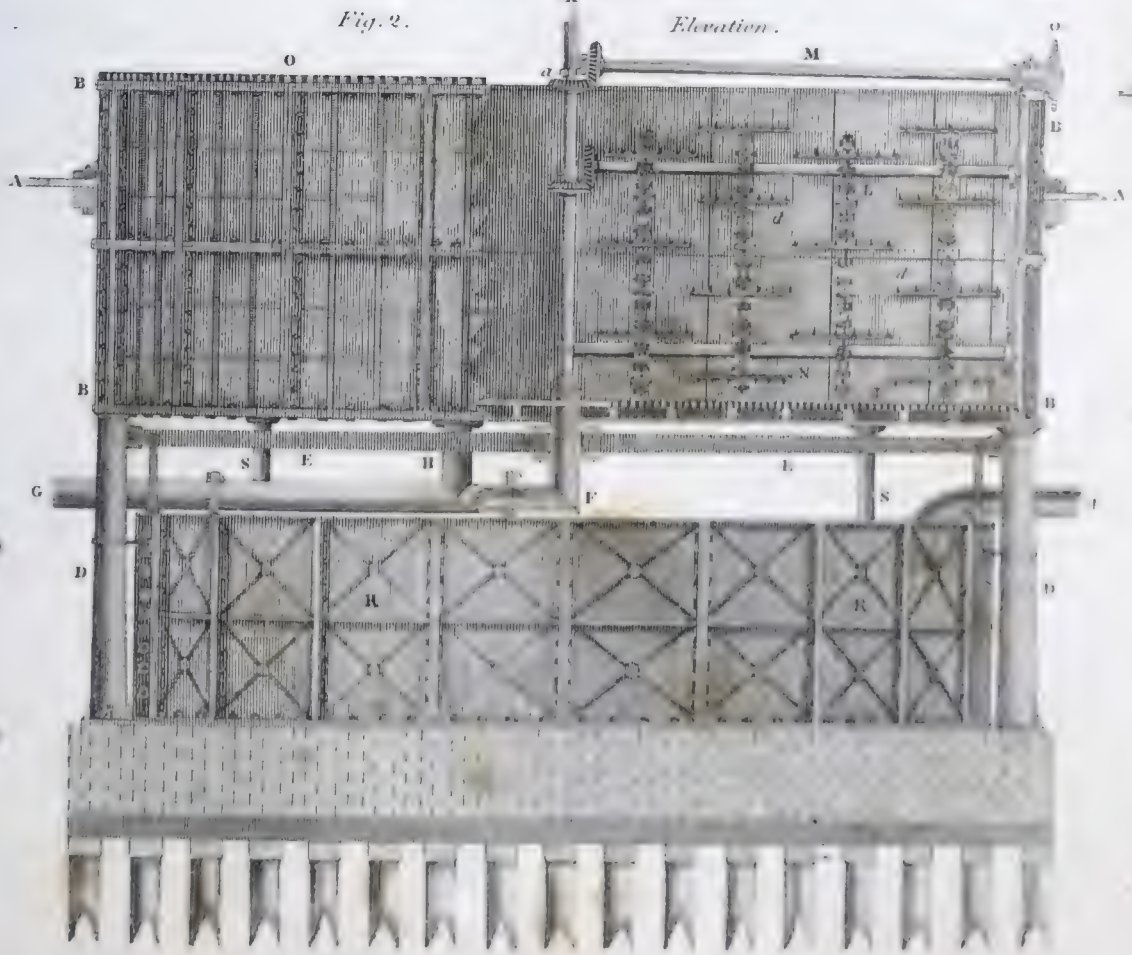




Fig. 1.

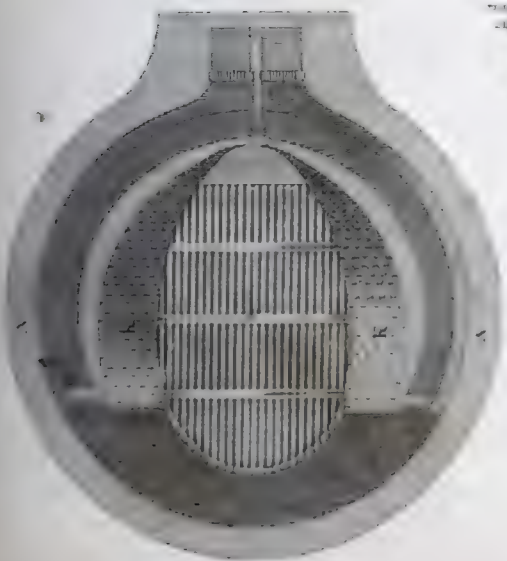


Fig. 2.

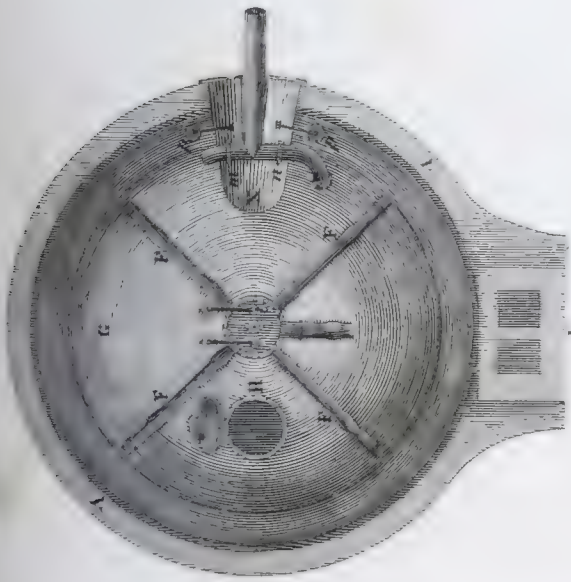


Fig. 3.

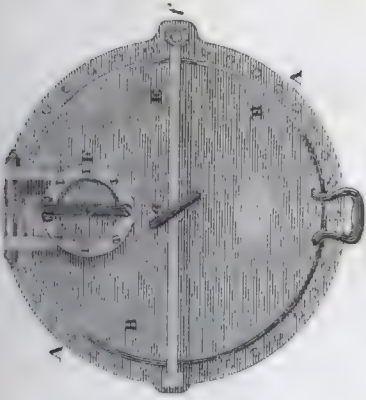


Fig. 6.



Fig. 3.

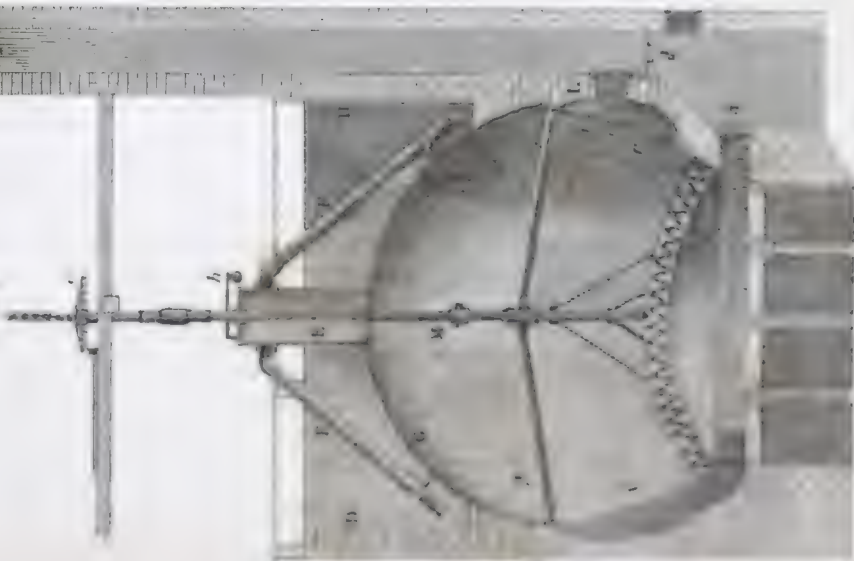


Fig. 1.

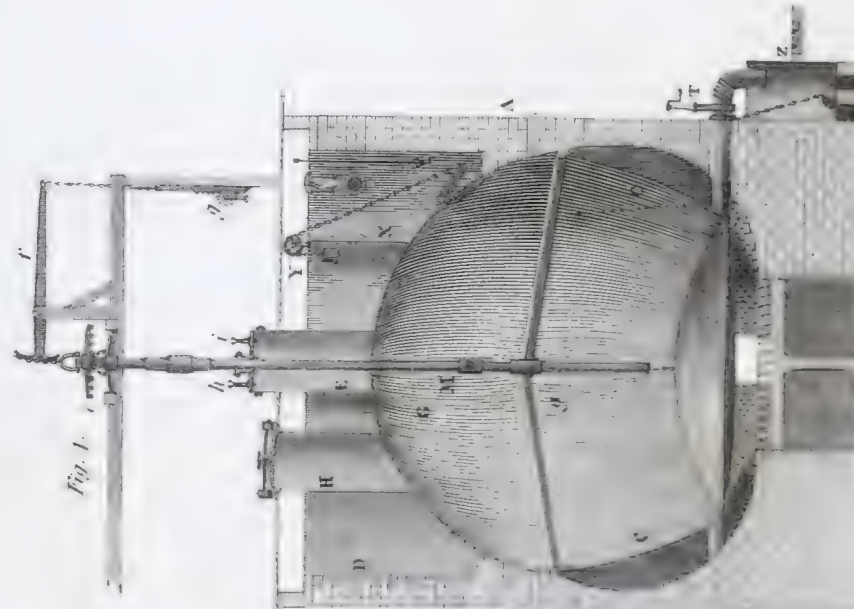


Fig. 7.

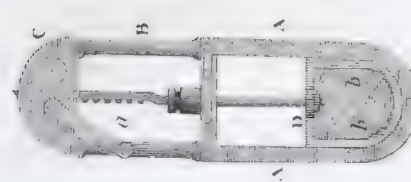


Fig. 8.

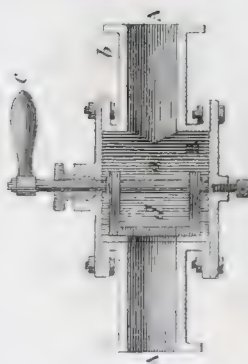


Fig. 9.

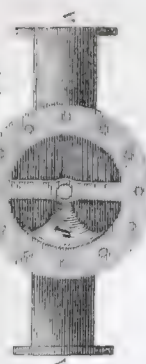


Fig. 10.

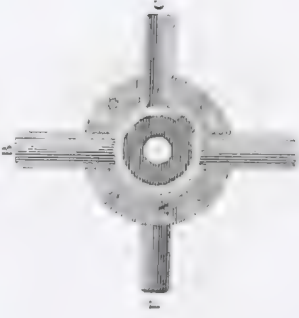


Fig. 12.



Fig. 13.

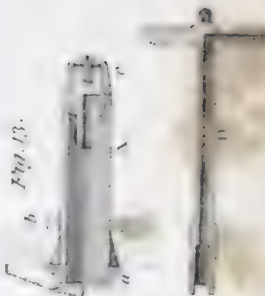


Fig. 11.



Scale 1/2 inch = 100 feet





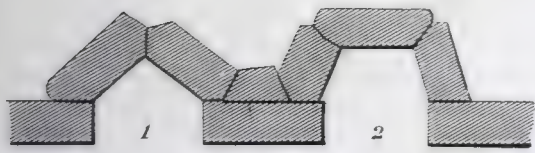


Fig. 1.



Fig. 2.

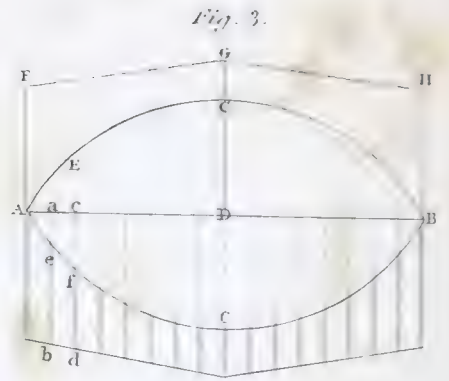


Fig. 3.

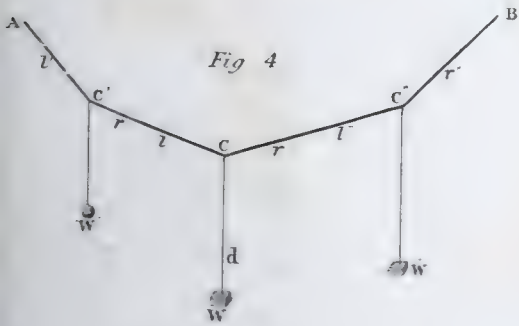


Fig. 4.

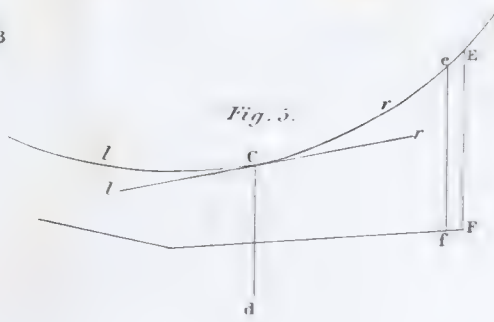


Fig. 5.



Fig. 7.

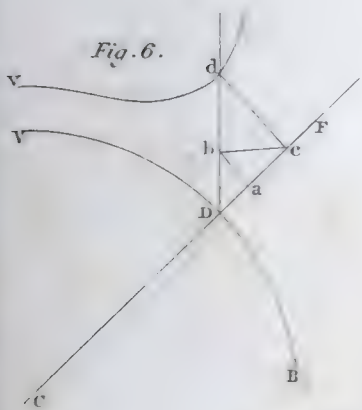


Fig. 6.

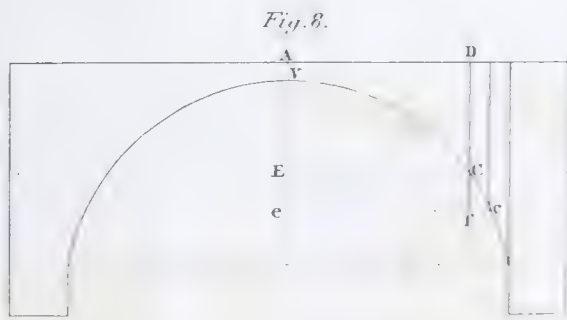


Fig. 8.

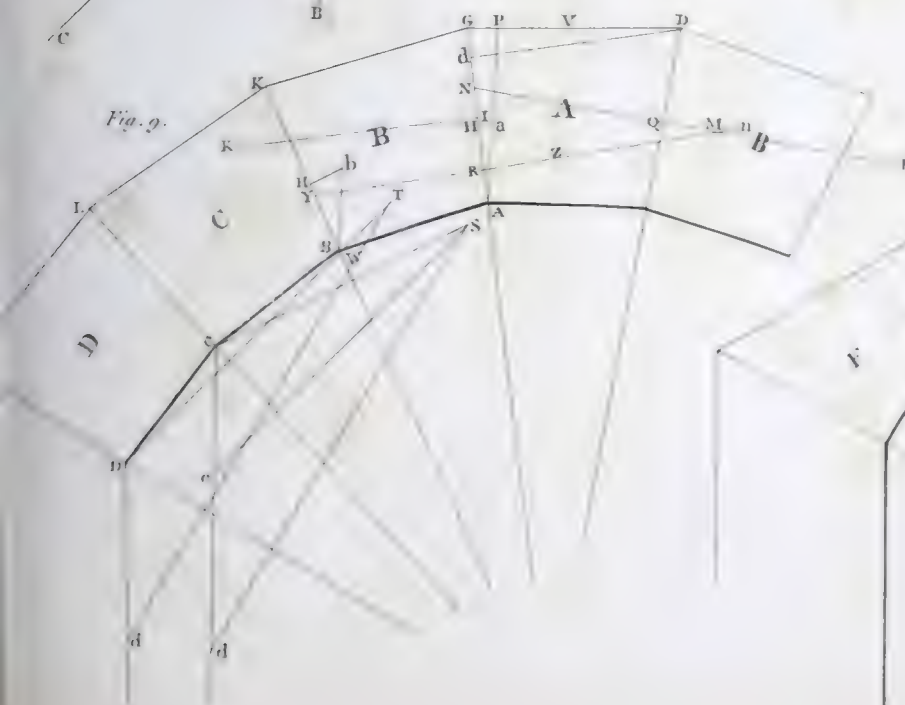


Fig. 9.

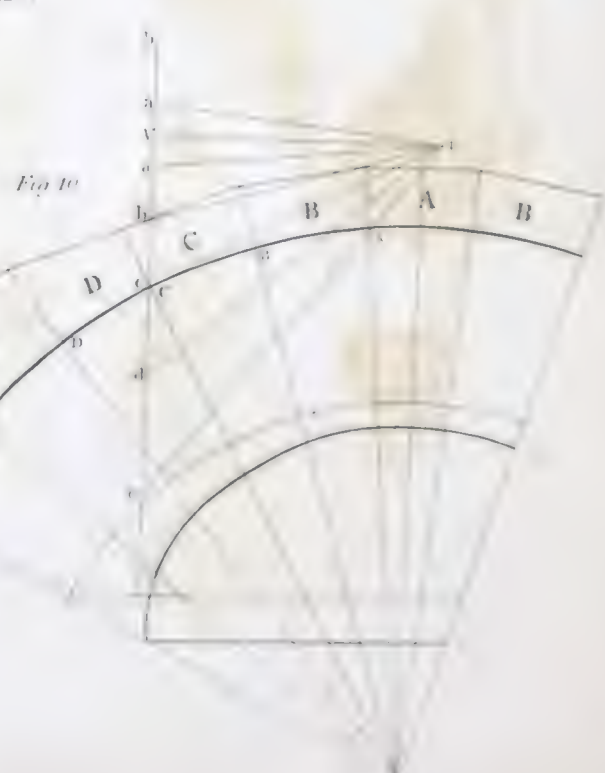


Fig. 10.



Fig. 1.

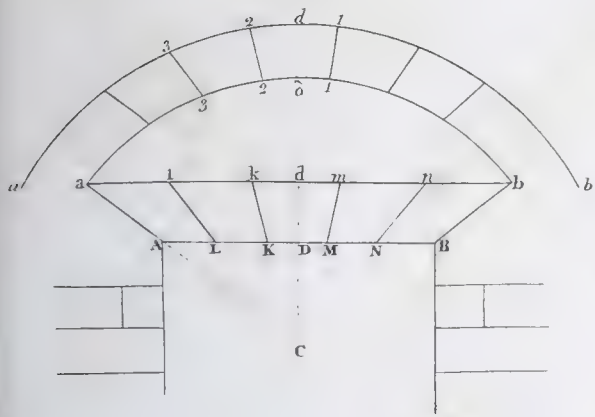


Fig. 2.

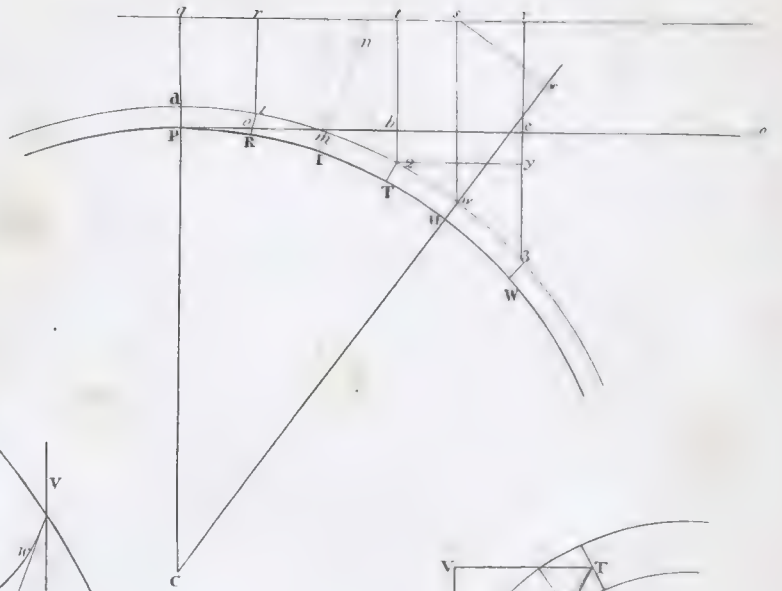


Fig. 3.

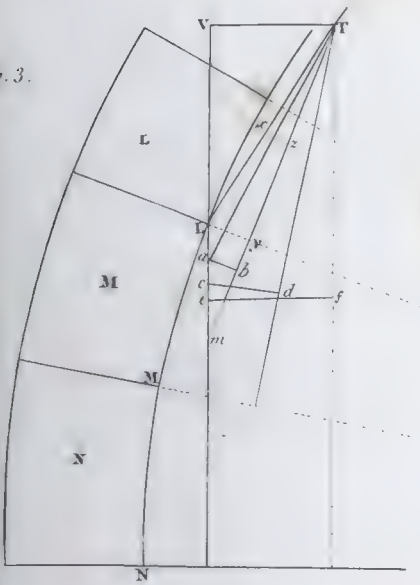


Fig. 4.

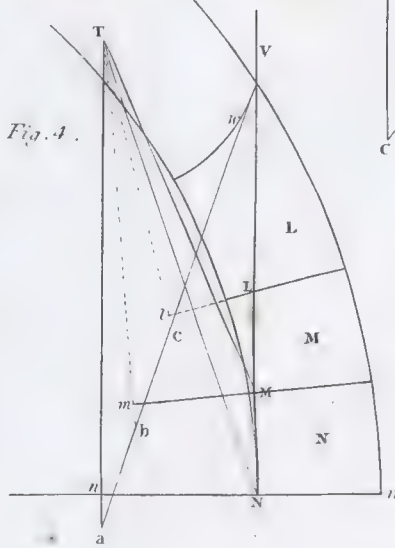
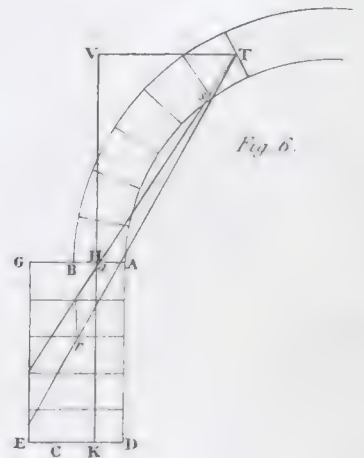


Fig. 6.



STERLINGS

Fig. 7.



Fig. 5.

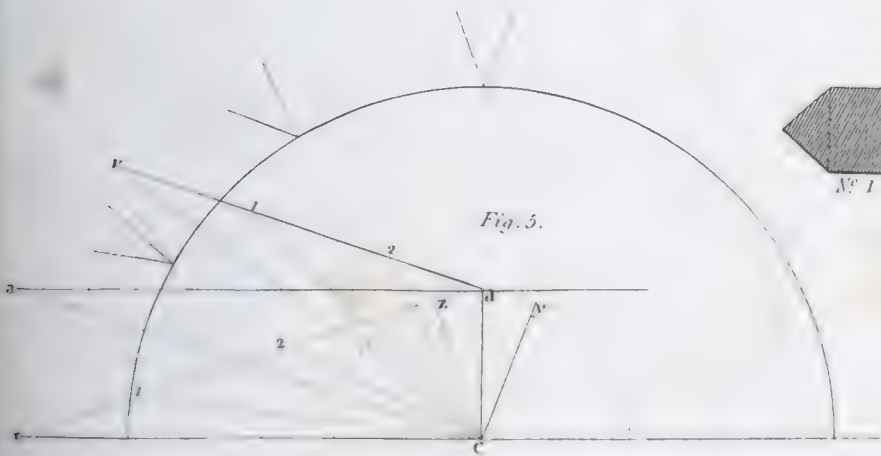


Fig. 8.

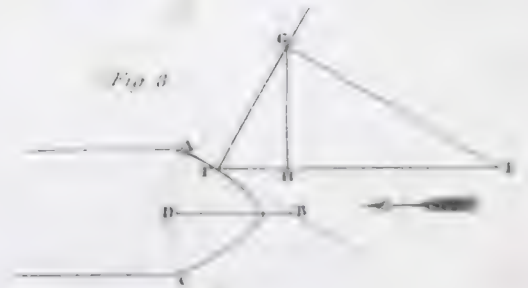


Fig. 9.

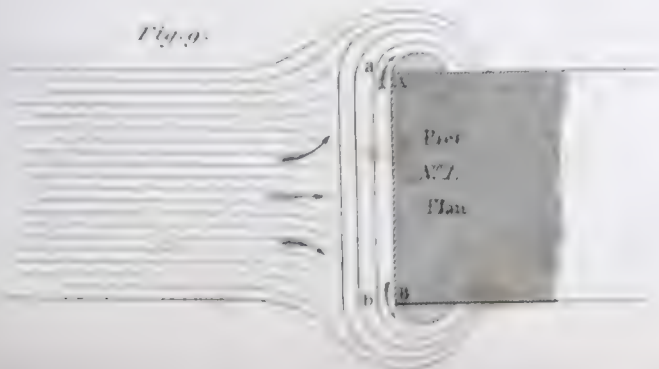
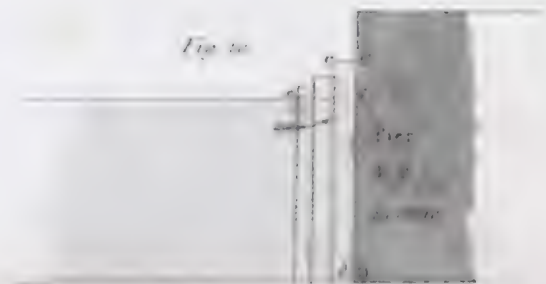
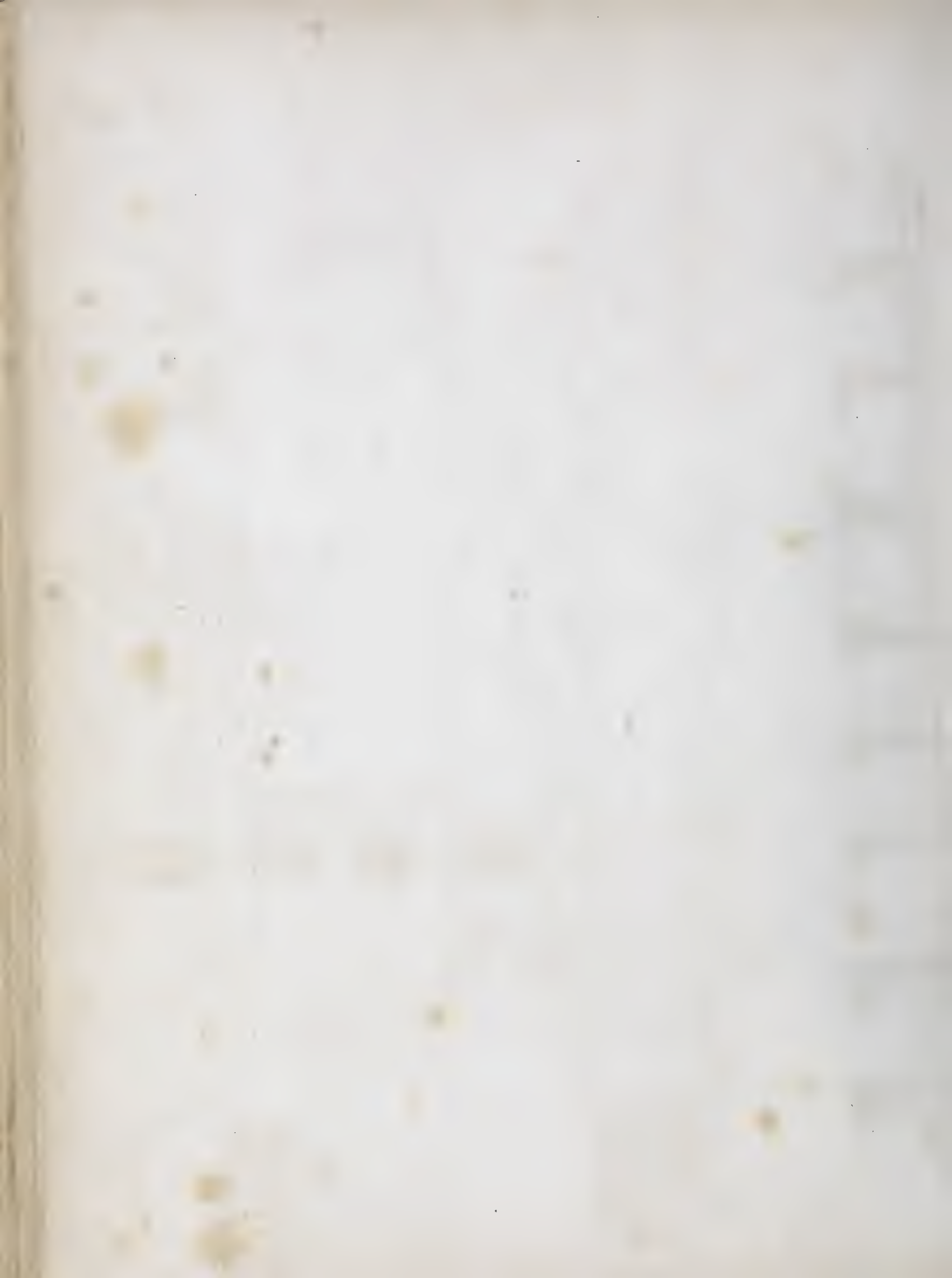
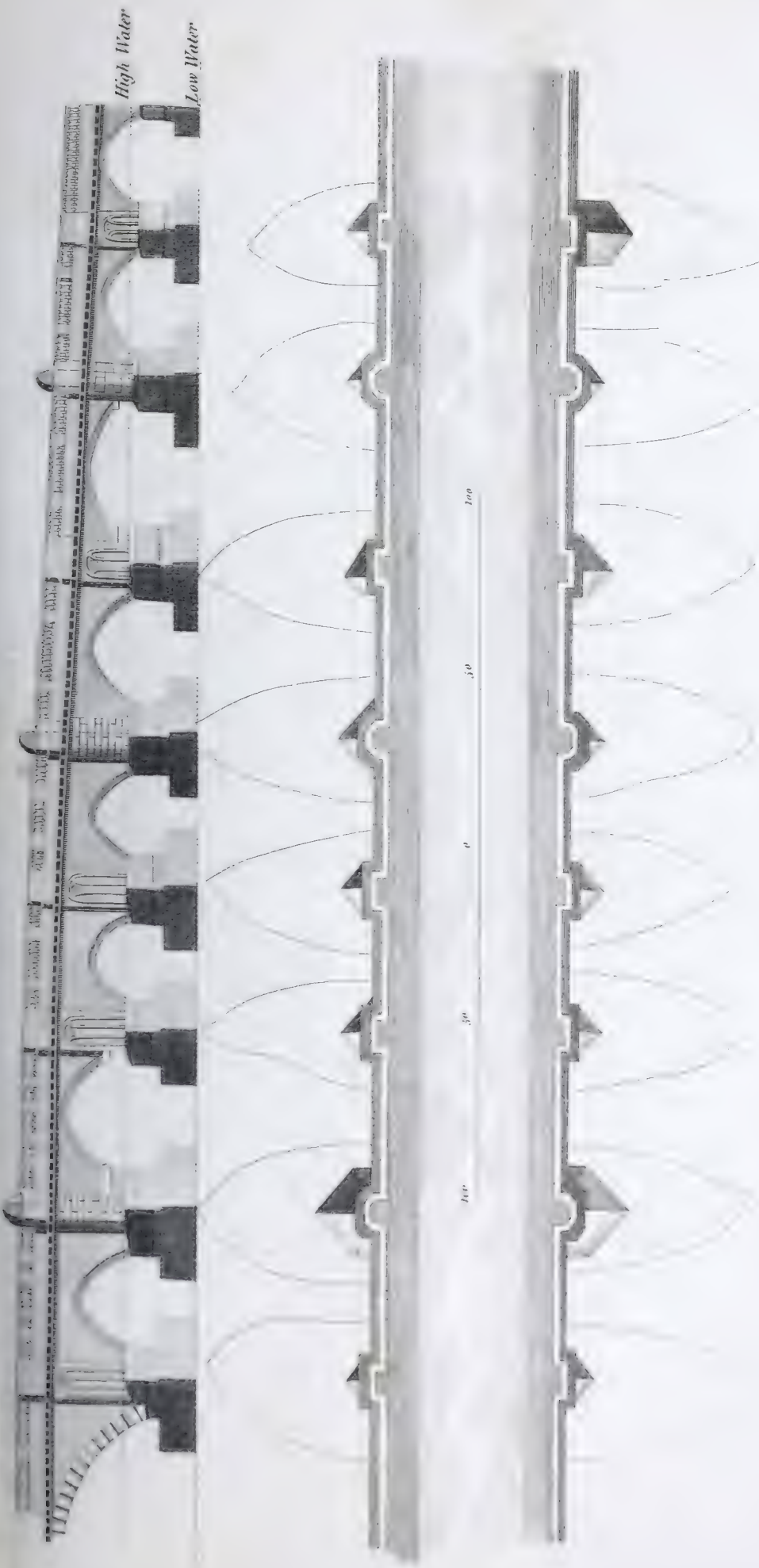


Fig. 10.







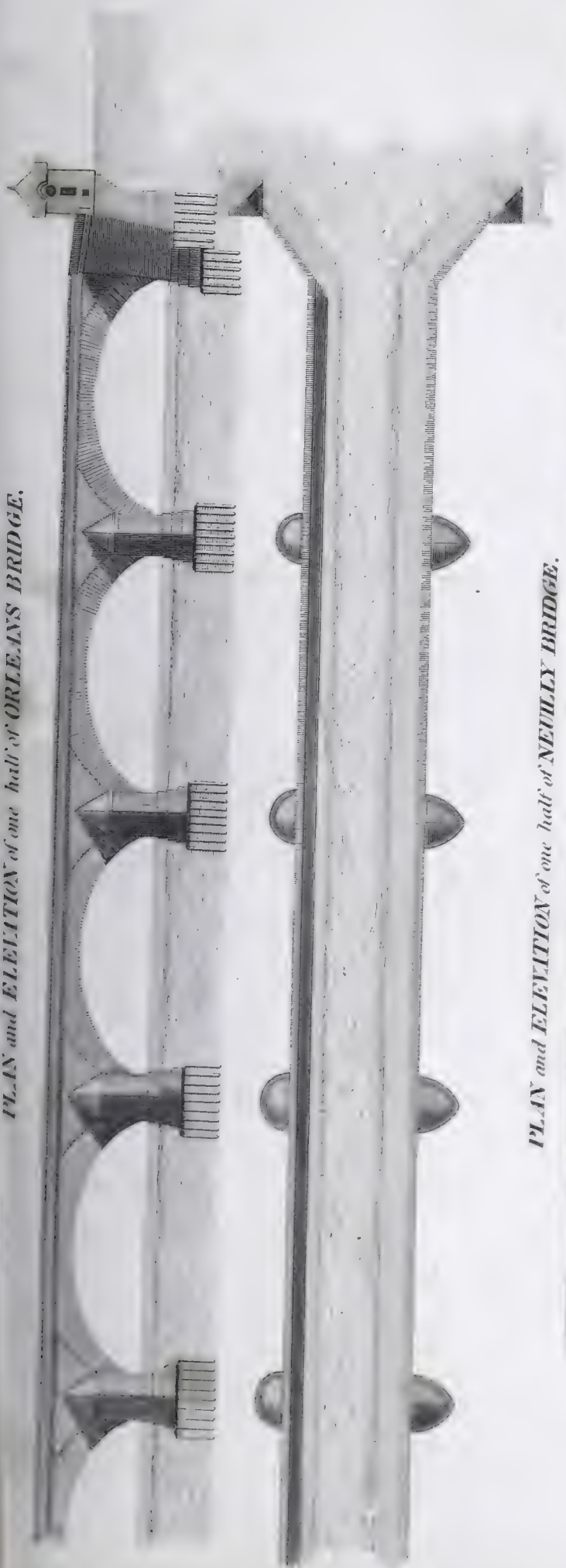
*Elevation of one half of the Pont de la Guillotière over the River Rosne at Lyons*



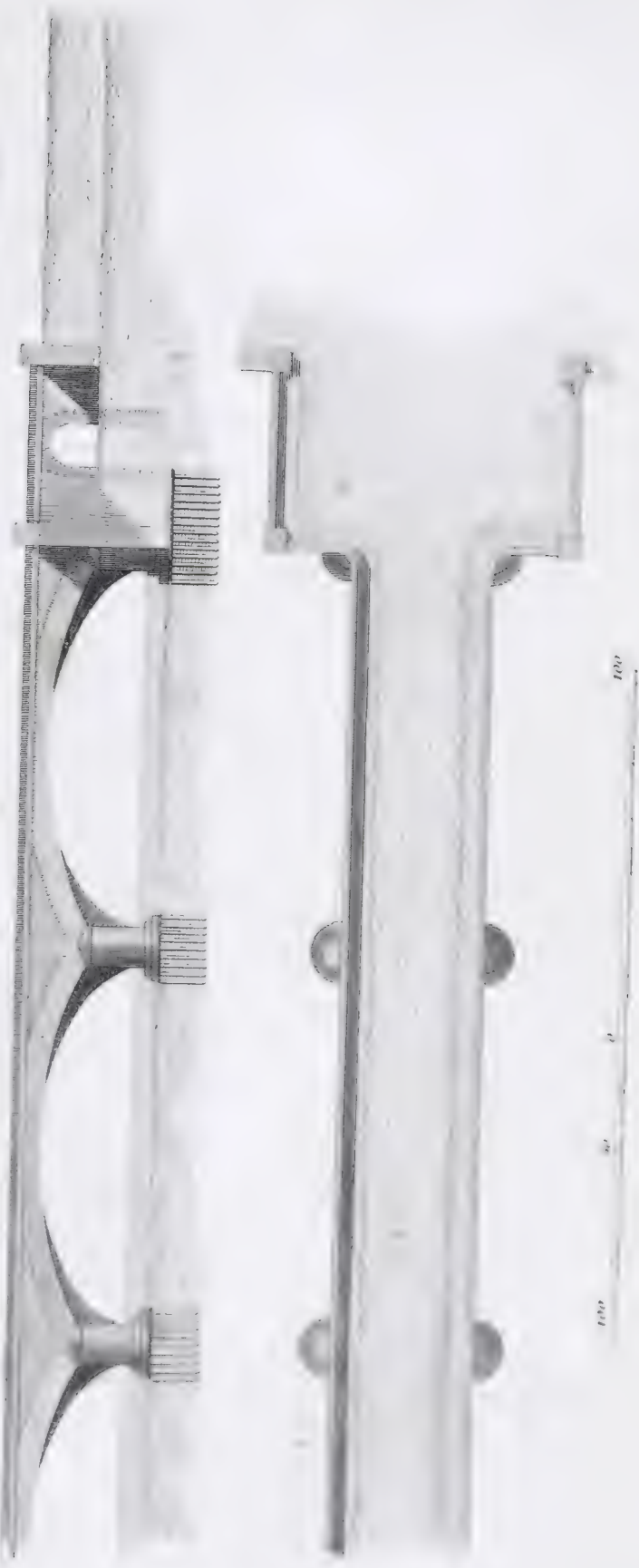
*Elevation of one half of the Pont du St-Esprit over the River Rosne at Languedoc*



*PLAN and ELEVATION of one half of ORLEANS BRIDGE.*



*PLAN and ELEVATION of one half of NEUILLY BRIDGE.*

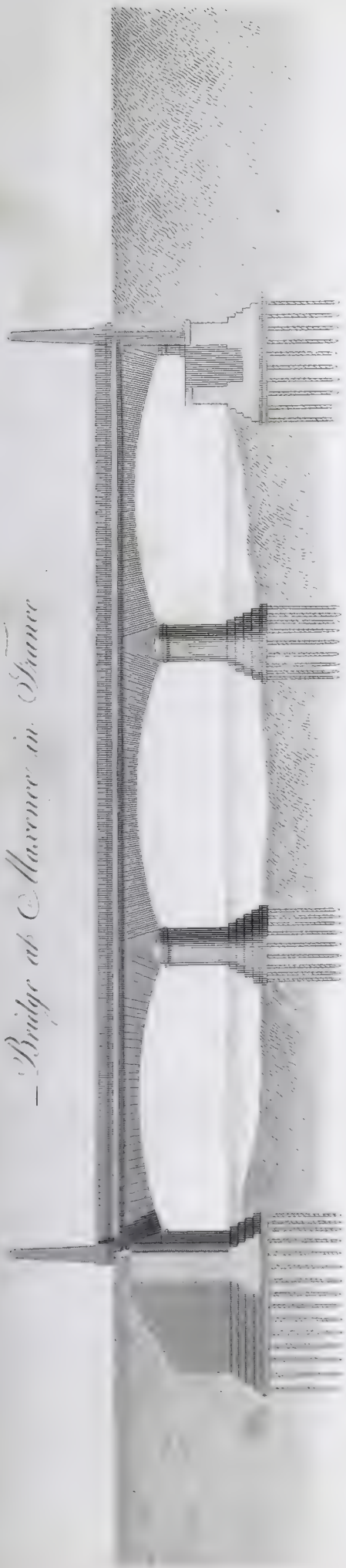




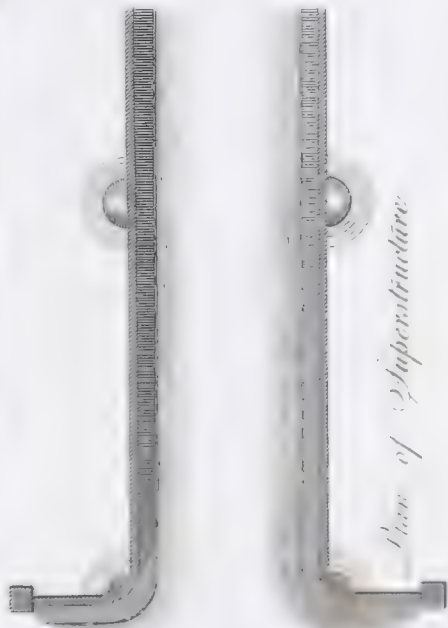
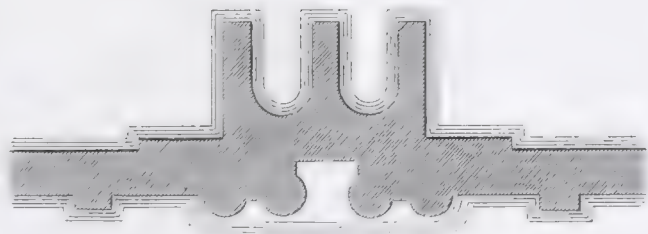


BRIDGE.

— Bridge at Havre in France



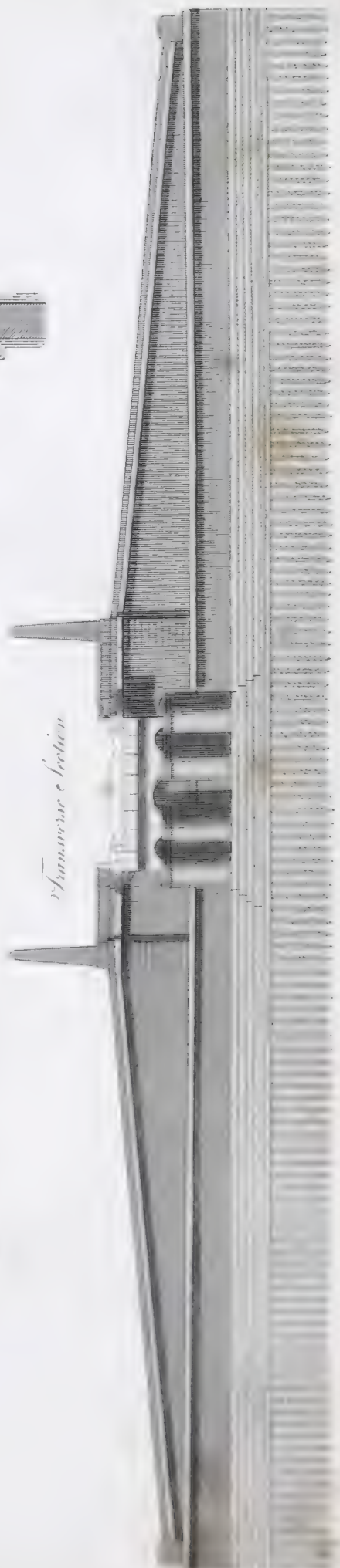
*Plan*



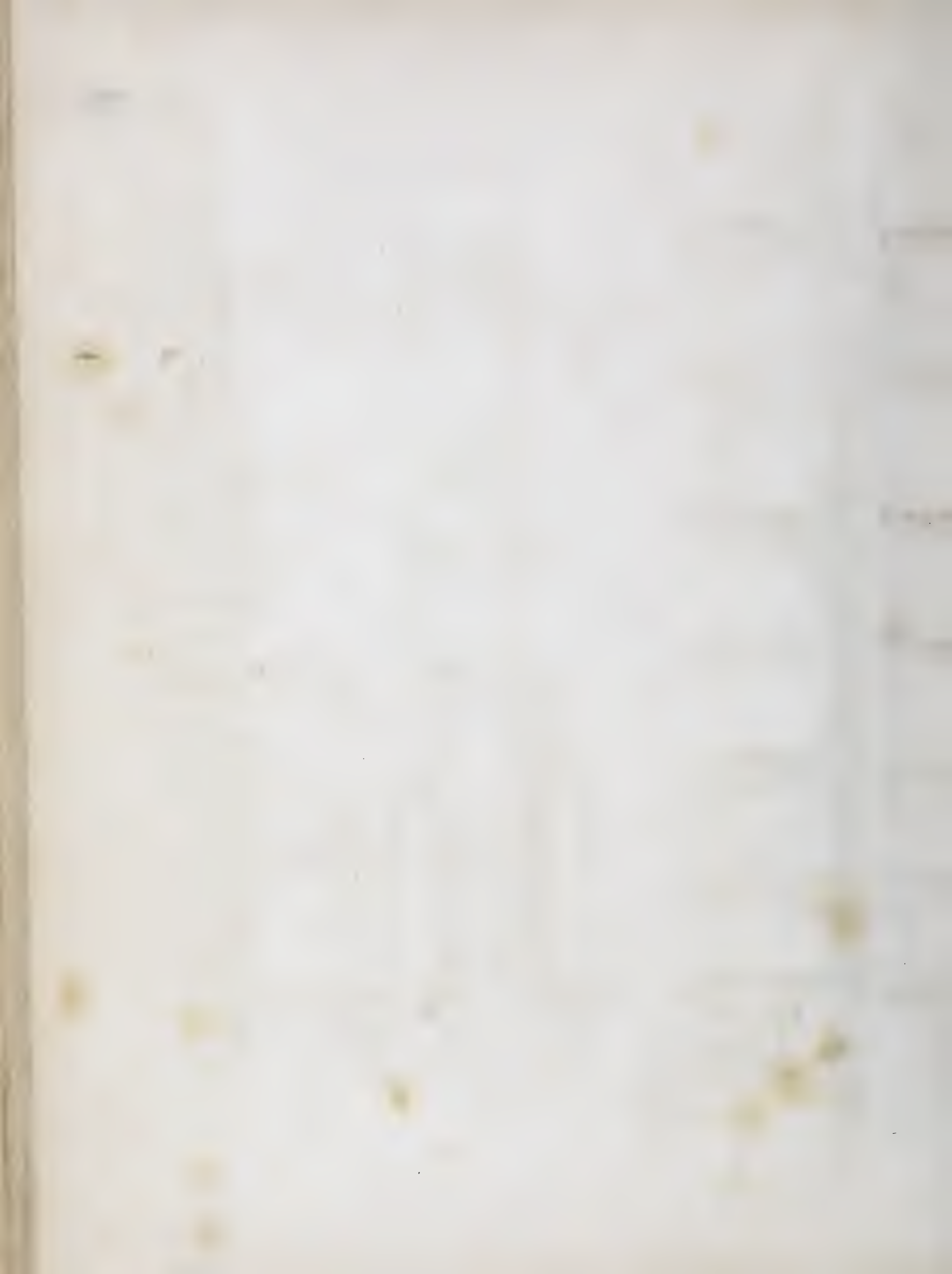
*View of Superstructure*

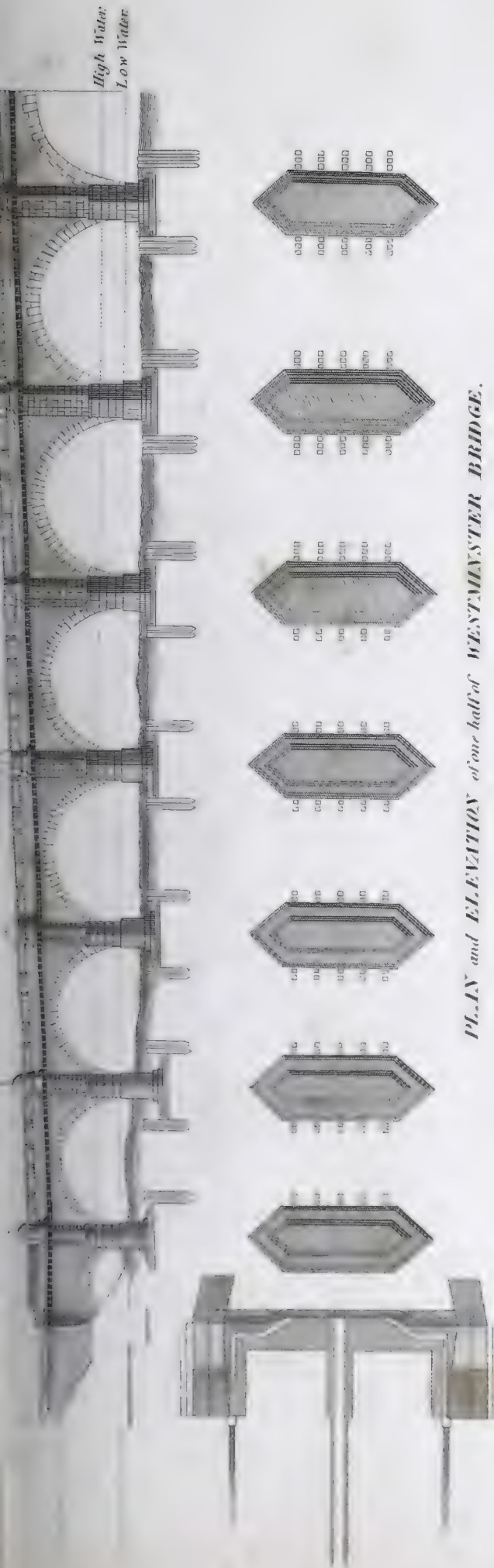


*of Truss*

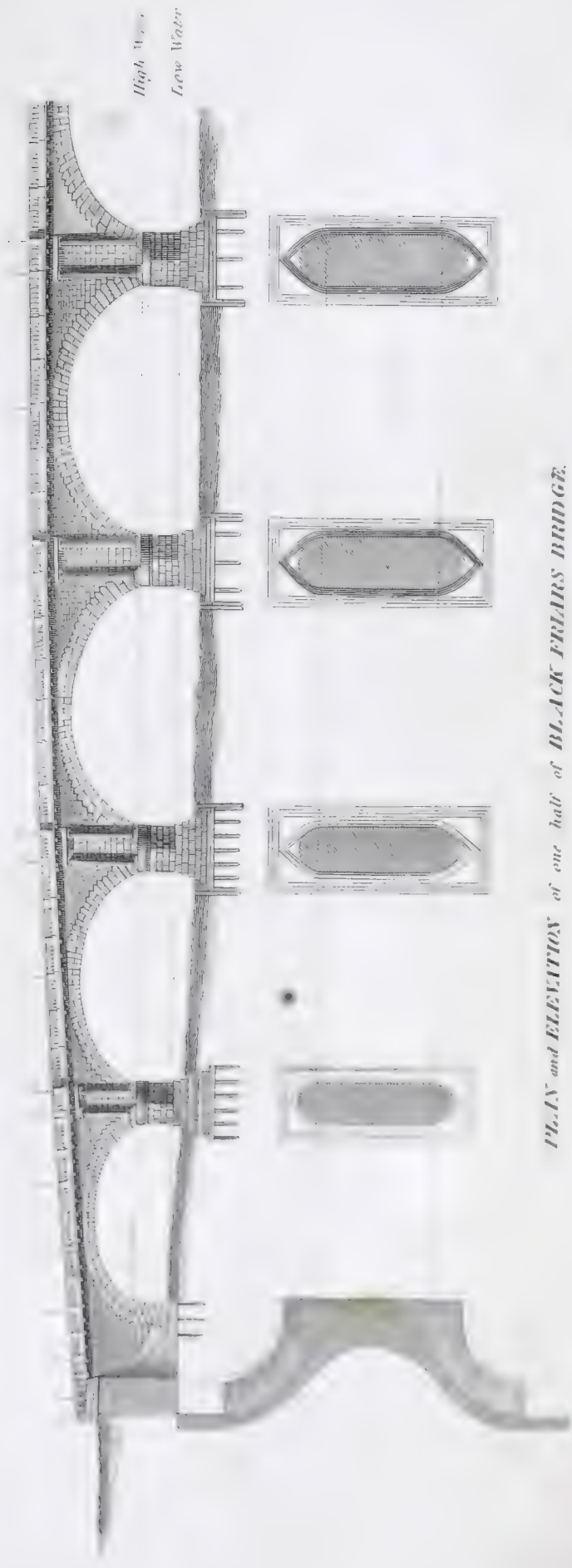


*Transverse Section*





*PLAN and ELEVATION of one half of WESTMINSTER BRIDGE.*

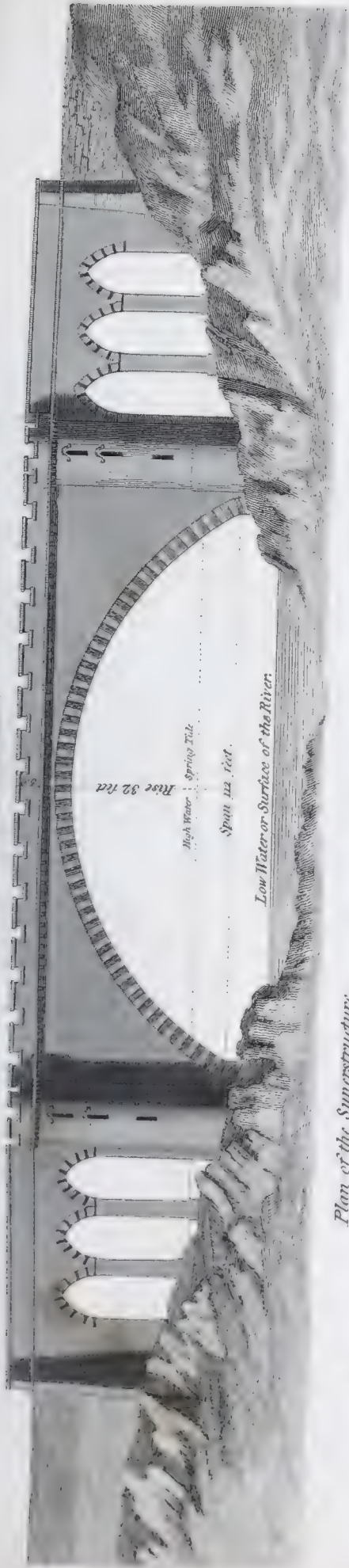


*PLAN and ELEVATION of one half of BLACK FRIARS BRIDGE.*

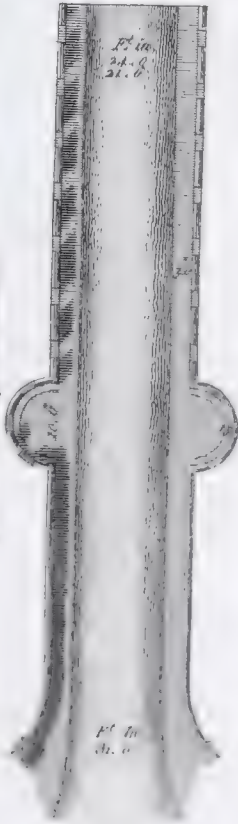


PLAN, ELEVATION and SECTIONS of a BRIDGE built over the RIVER DEE at TONQUELAND in the STEWARTRY of GALLOWAY.

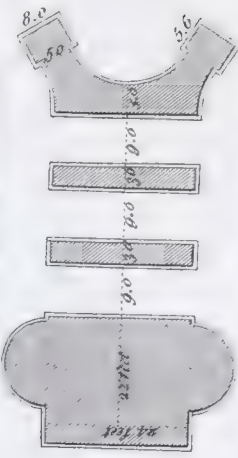
General Elevation.



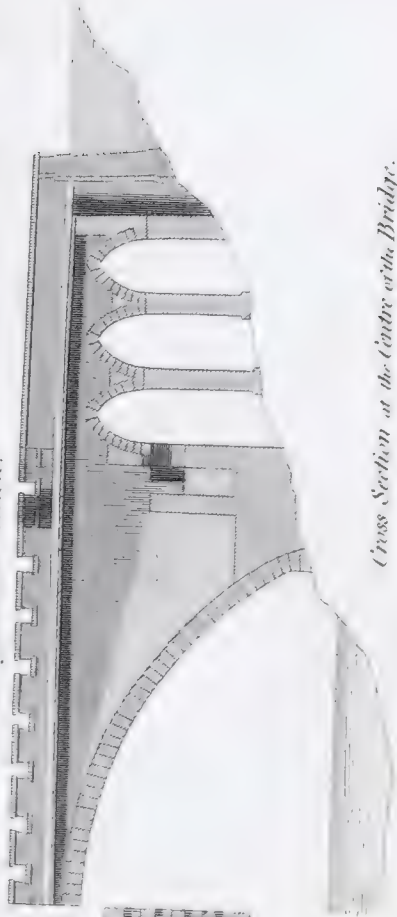
Plan of the Superstructure.



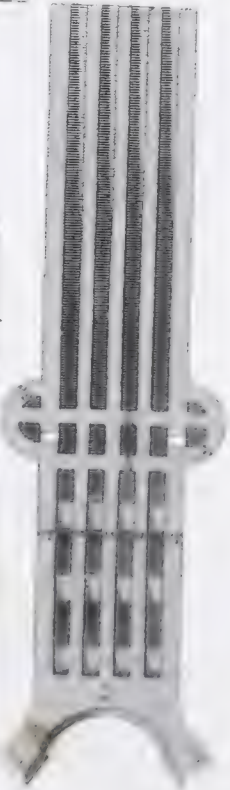
Plan of the Foundations.



Longitudinal Section.



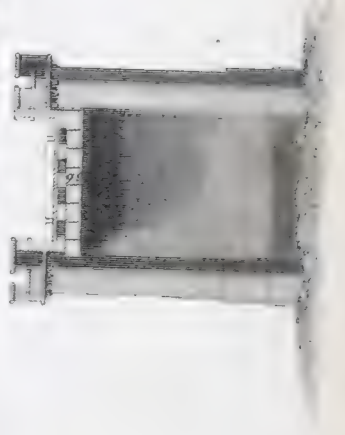
Horizontal Section of the Spandrels.



Cross Section through the Towers.



Cross Section at the Centre of the Bridge.

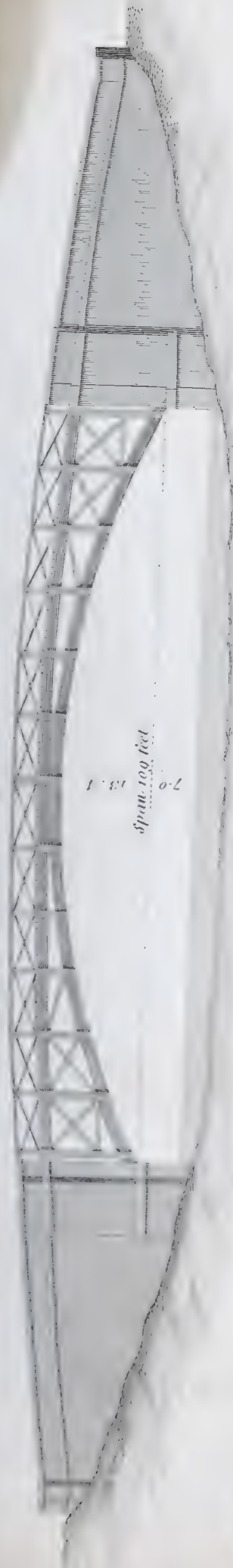




BRIDGE.

TIMBER BRIDGE over the RIVER DON at DYCE in DERBYSHIRE.

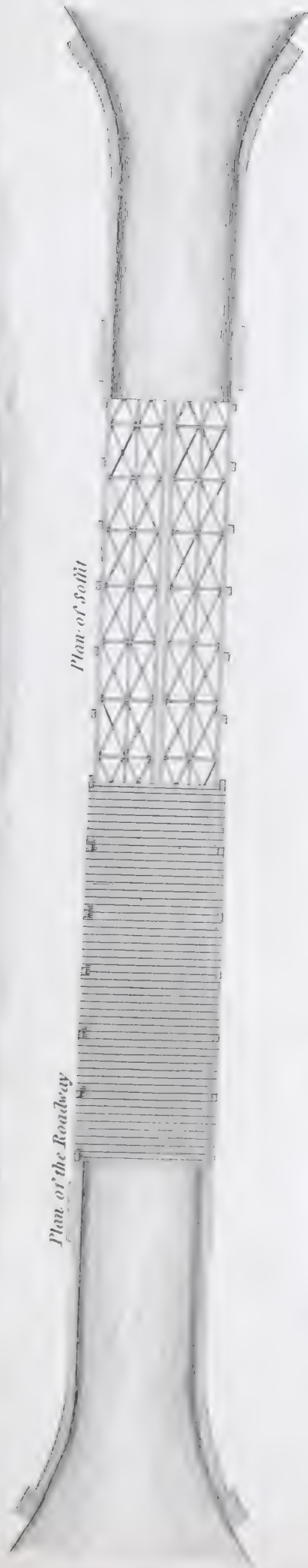
Elevation.



Span 100 feet.

Plan of the Roadway

Plan of Soffit



WOODEN BRIDGES from PALLADIO.







Fig 1.



10 20 30 40 50 60 70 80 90 100  
Feet



Fig 1

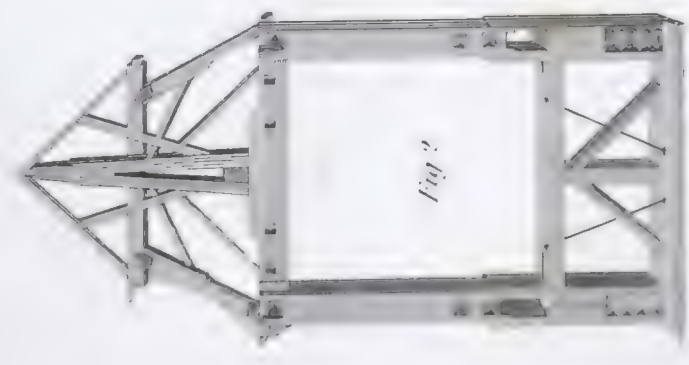


Fig 2

*At the Wooden Bridge  
at Schaffhausen  
in Switzerland*

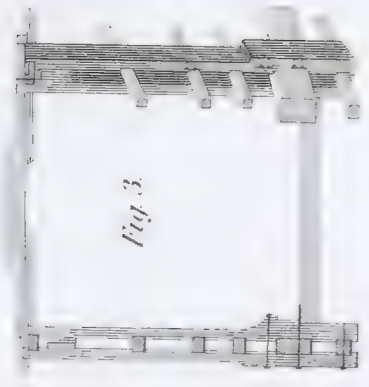


Fig 3



Fig 4

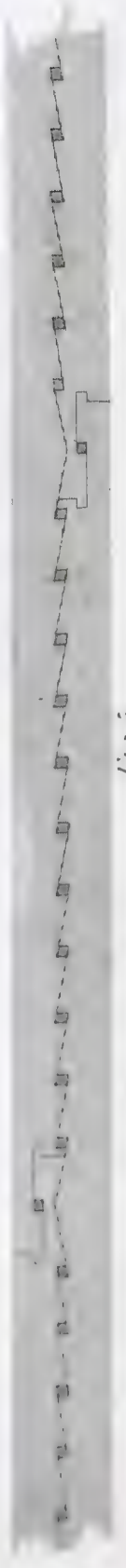
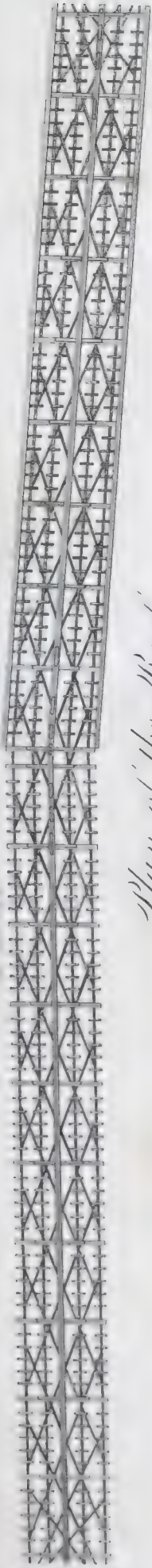


Fig 5



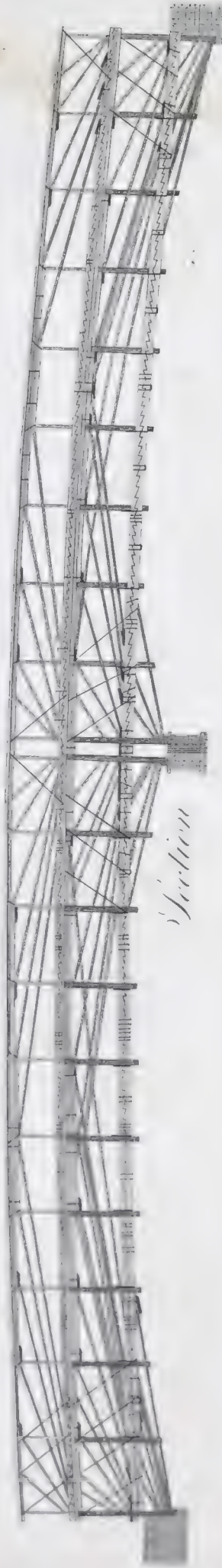
The Wooden Bridge at Schaffhausen  
in Switzerland

Fig. 3.



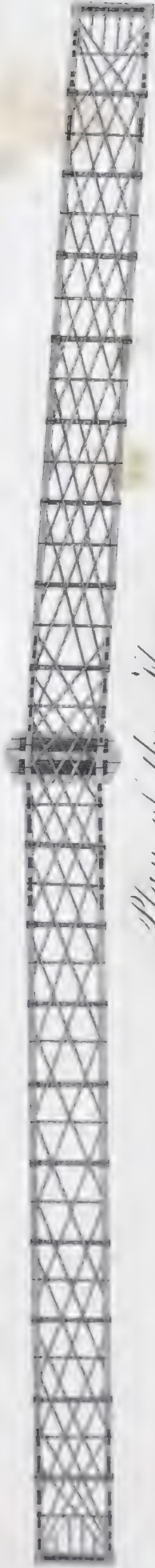
— Plan of the Roof

Fig. 1.

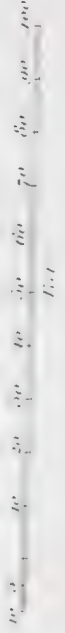


Section

Fig. 2.



— Plan of the Floor

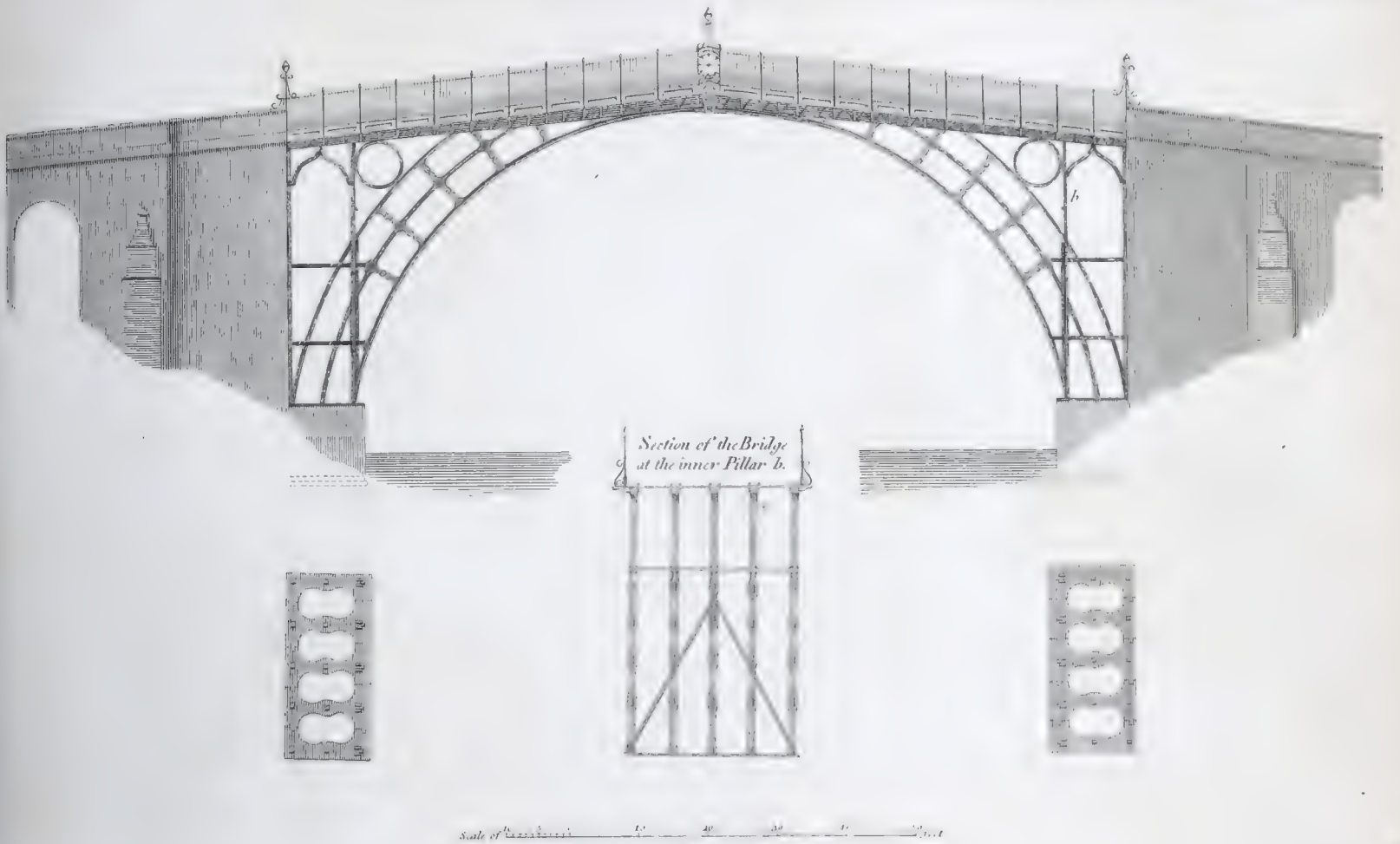




# BRIDGE.

# PLATE XCI.

*PLAN ELEVATION and SECTION of the FIRST IRON BRIDGE built over the RIVER SEVERN near COALBROOK-DALE in the COUNTY of SALOP.*

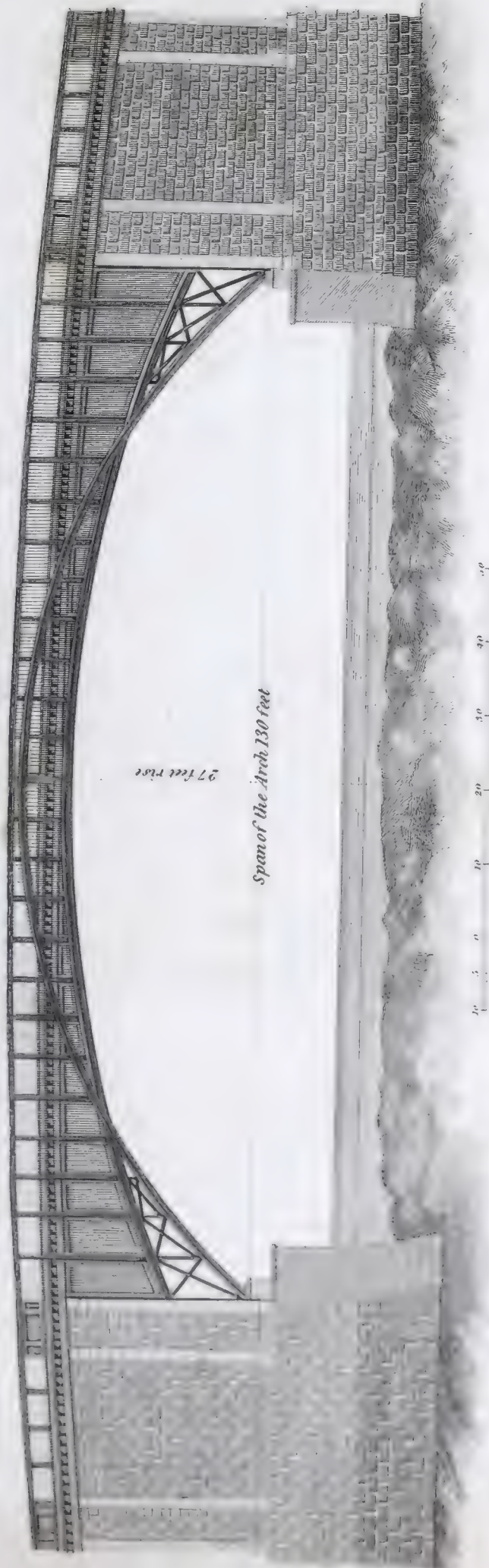


*ELEVATION of the IRON BRIDGE built over the RIVER WEAR at SUNDERLAND in the COUNTY of DURHAM.*





PLAN ELEVATION and SECTIONS of the IRON BRIDGE built over the RIVER SEVERN at BUILDWAS in the COUNTY of SALOP in the years 1795 and 1796.



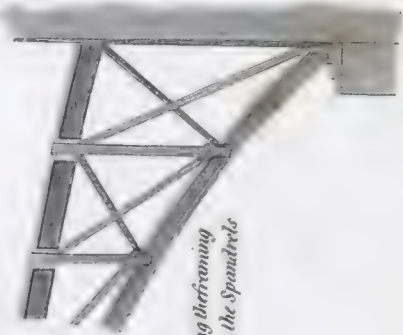
Plan of the Abutment



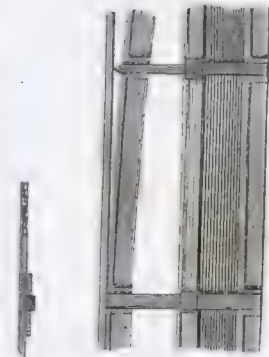
Section showing the Roadway and the Soffit of the Arch.



Section showing the Framing of the Braces in the Spandrels



Section showing the manner in which the two Ribs are connected by the King Posts at the centre



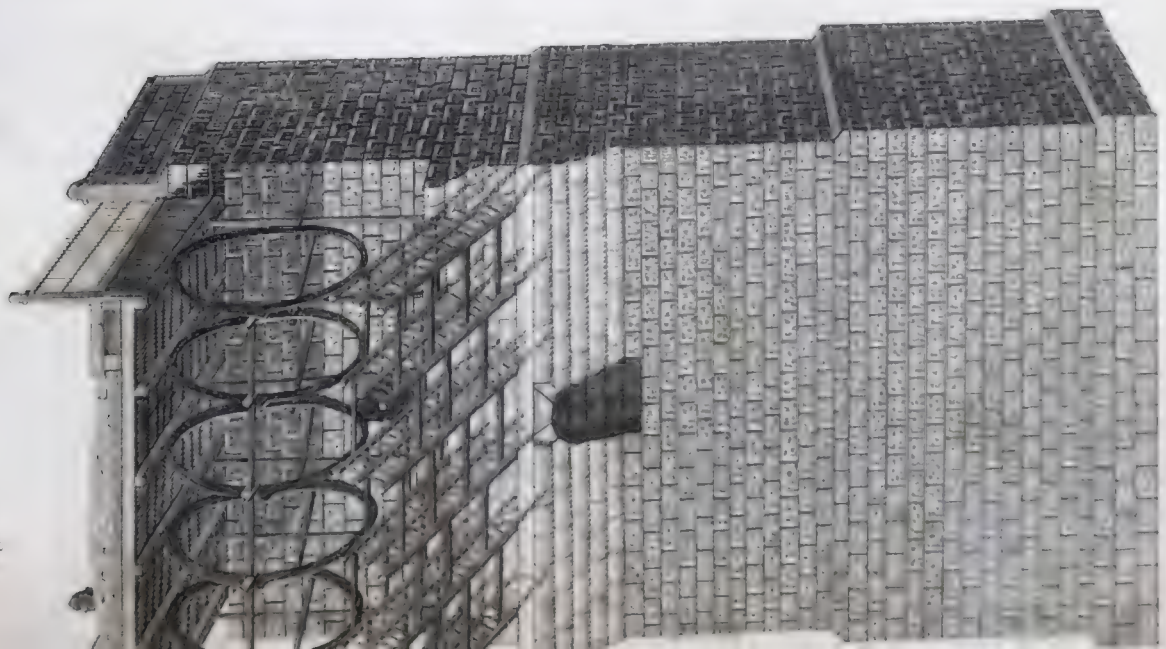
Section of Railing





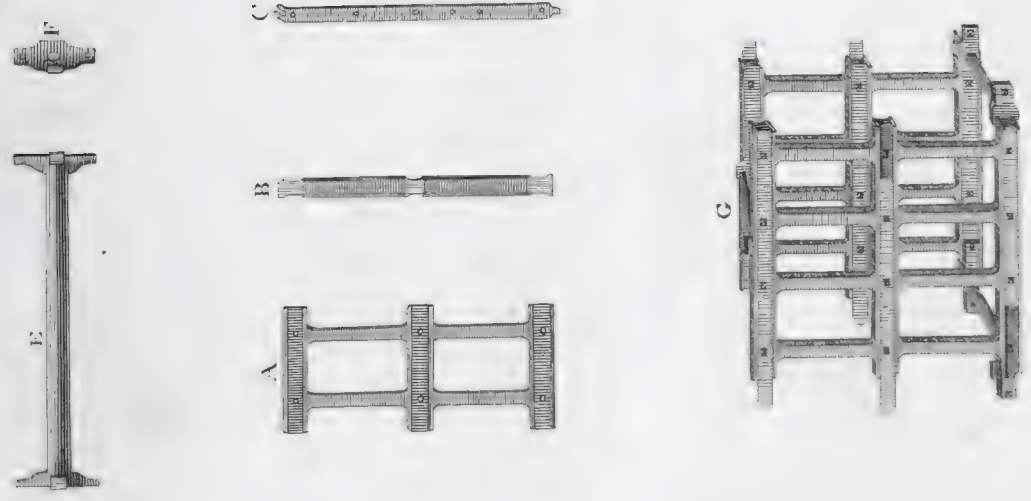


Fig. 5.



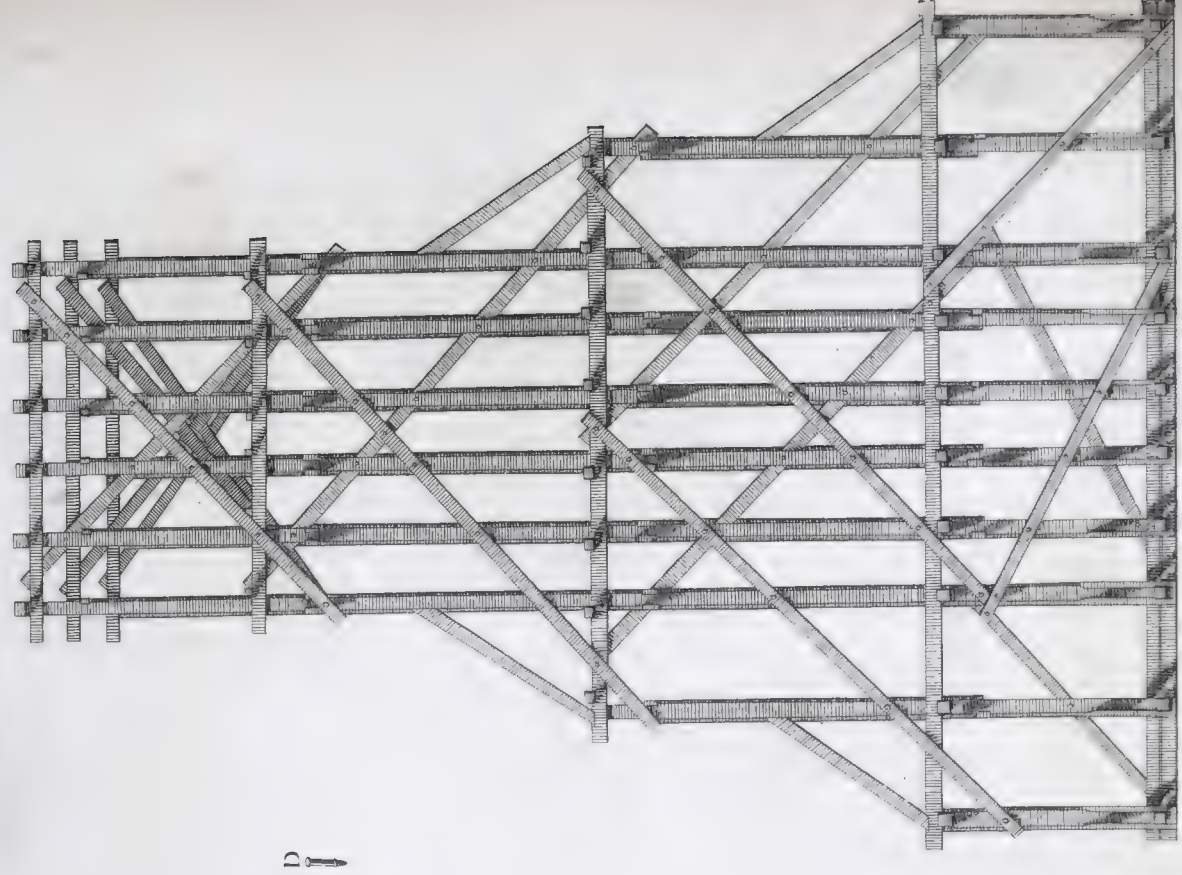
Scale of Feet

Fig. 1.



Scale of Feet

Fig. 2.

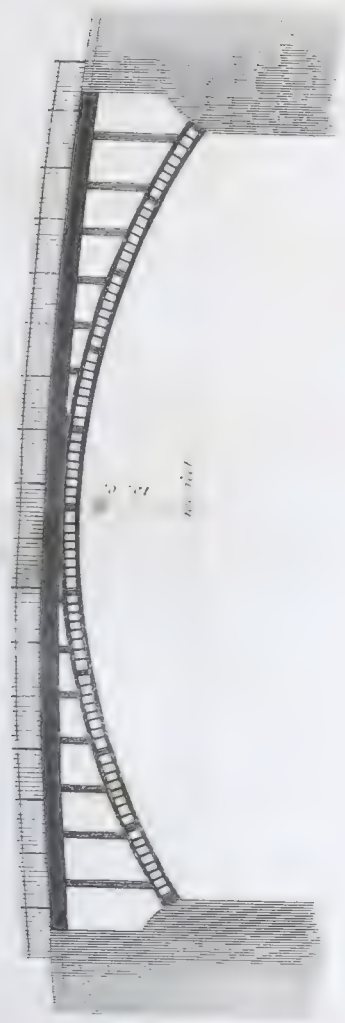


Scale of Feet

Engineered by W. Charlot.



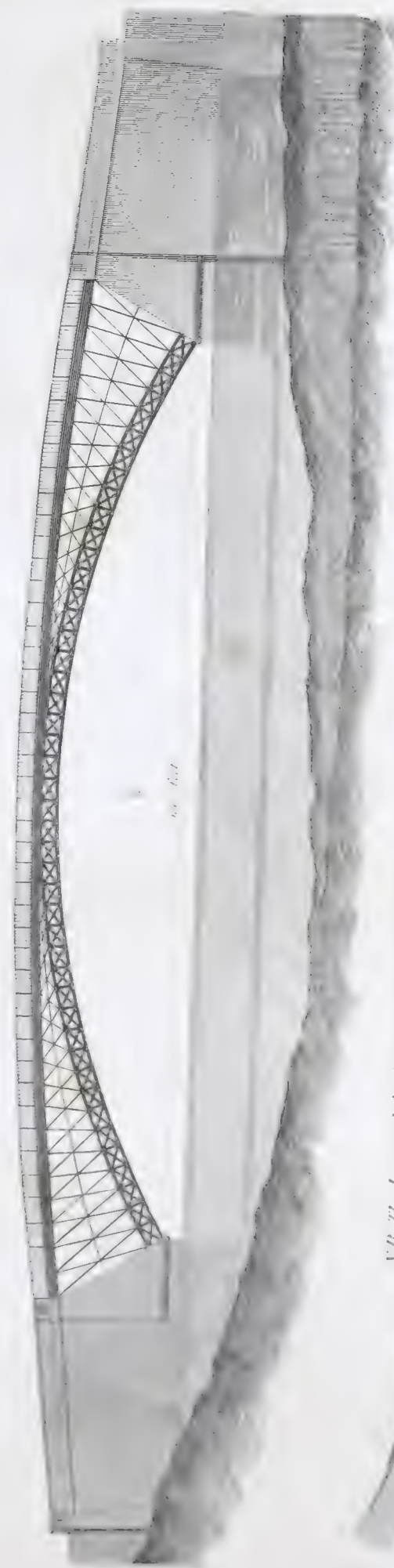
*Bristol Bridge*



*Eastern Bridge*



*Bonar Bridge*

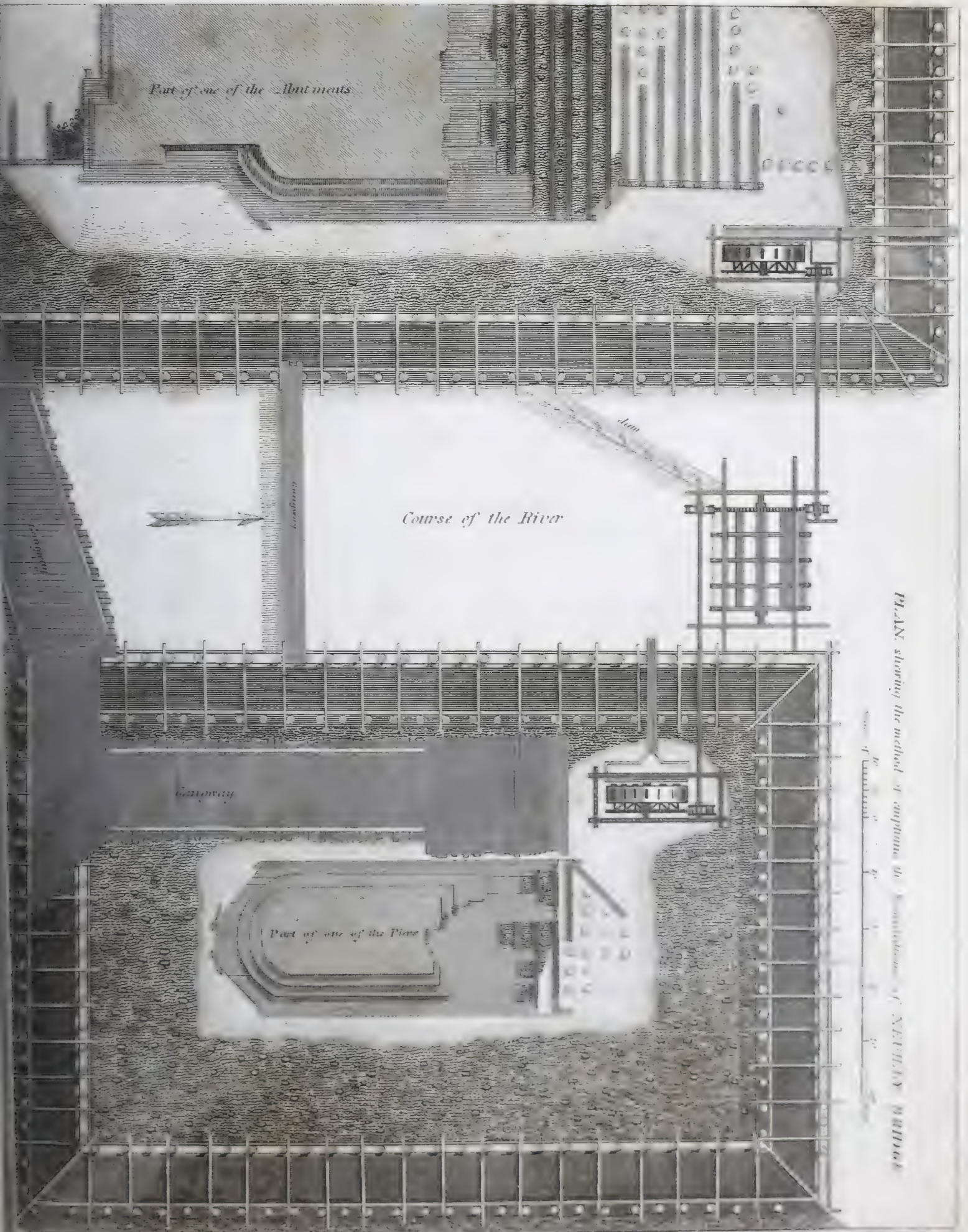


*A.B. The Iron work for the Manai Bridge of two feet span is on the same principle as this in all respects.*



*Manai Bridge*





PLAN showing the method of employing the Scaffolding of NEWTON BRIDGE

Scale of Lengths in Feet



Fig. 4. COFFERDAM used for rebuilding PULTENEY BRIDGE, BATH.

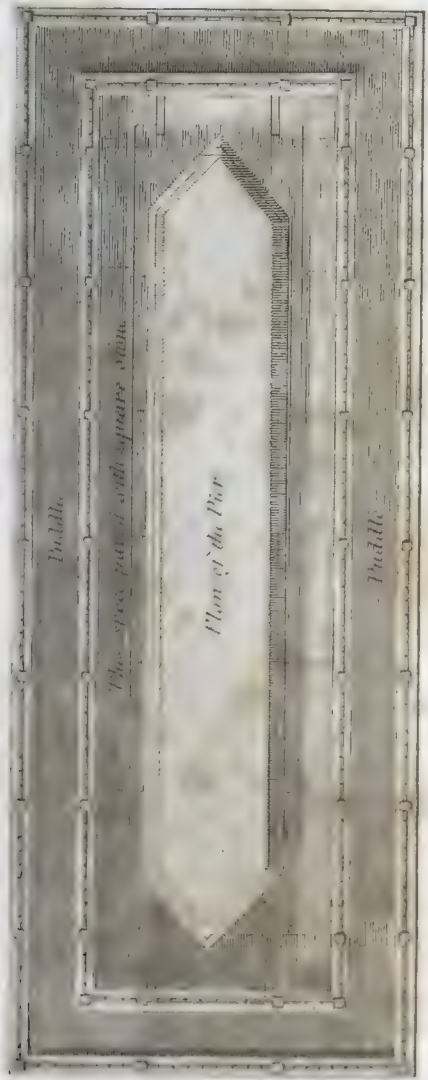


Fig. 5.

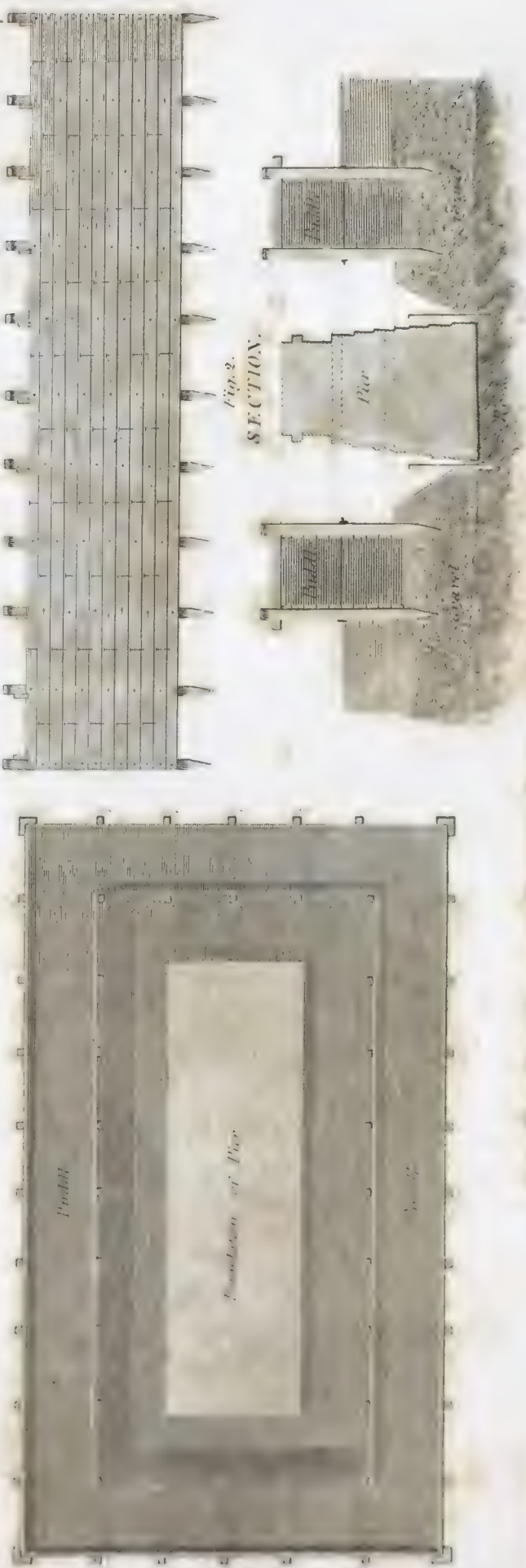
SECTION.



Fig. 1. COFFERDAM used for building BEWLEY BRIDGE.

Fig. 2.

SECTION.



H. Anderson, Jr.





Fig. 1.  
Cofferdam for founding a Pier by a single row of Piles.

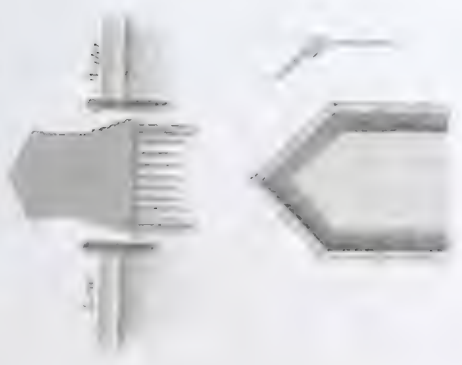


Fig. 2.  
Caisson for founding the Piers of a Bridge.

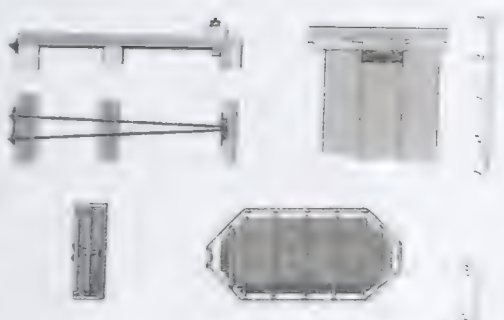


Fig. 3.  
Circular Cofferdam

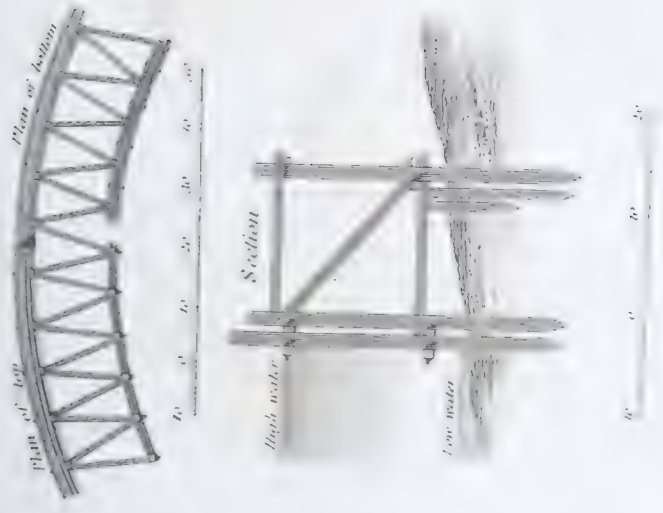


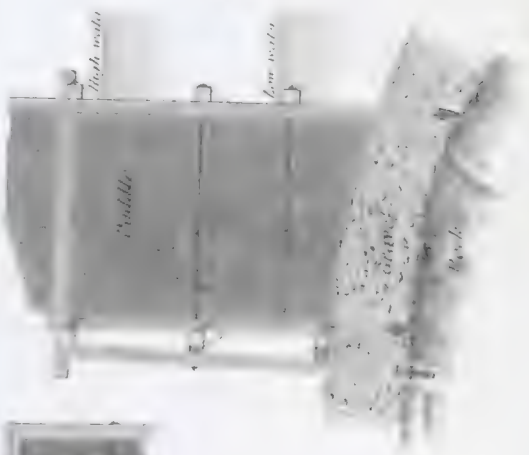
Fig. 3.  
COFFERDAM used for founding the SHALLOCK at the Western entrance of the CALEDONIAN CANAL.

General Plan

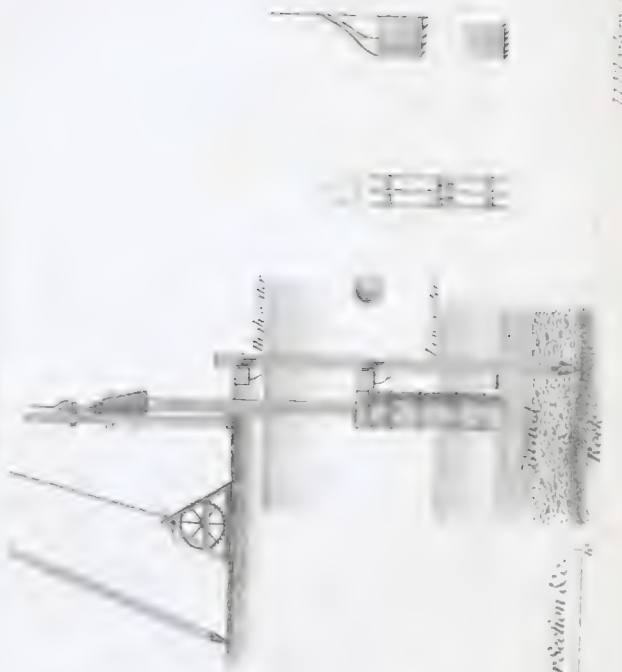


Scale of feet for General Plan

Section at A



Method of driving down the Cylinder.

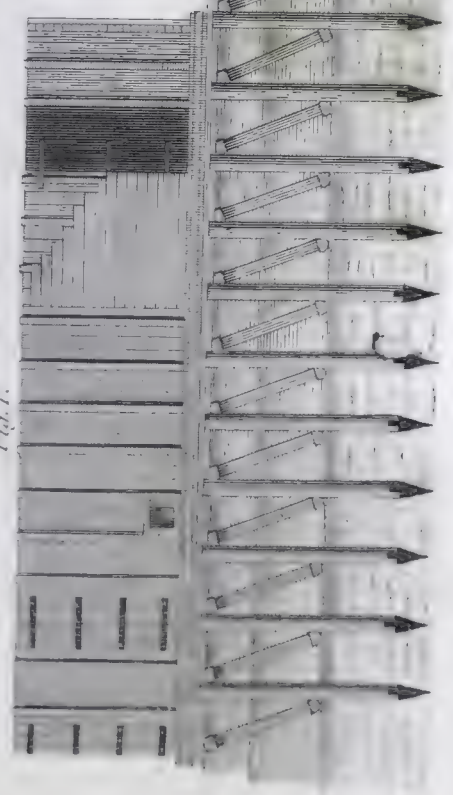


Scale of feet for Section A &c.



CAISSON USED FOR FOUNDING THE PIERS OF WESTMINSTER BRIDGE.

Elevation of one side with a section of the end. Fig. 1.

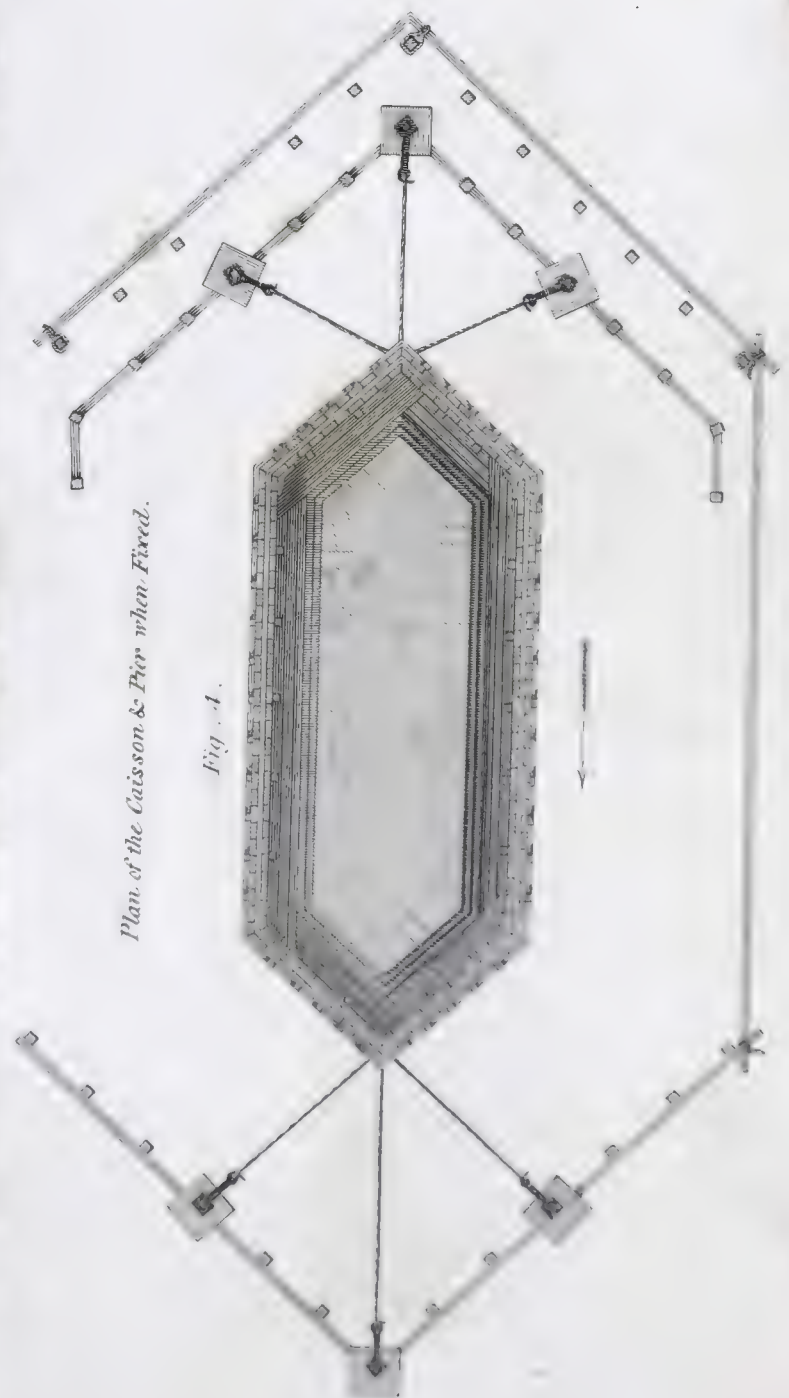
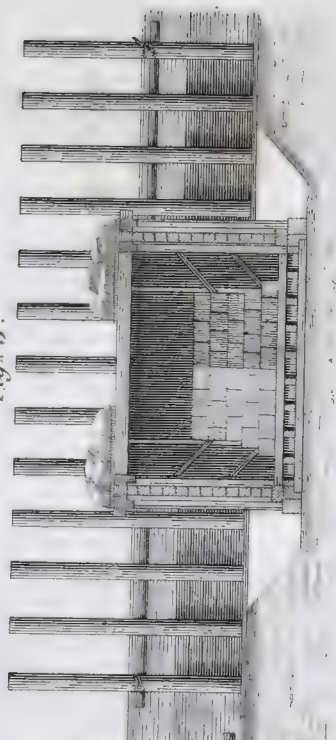


Elevation of one end. Fig. 2.

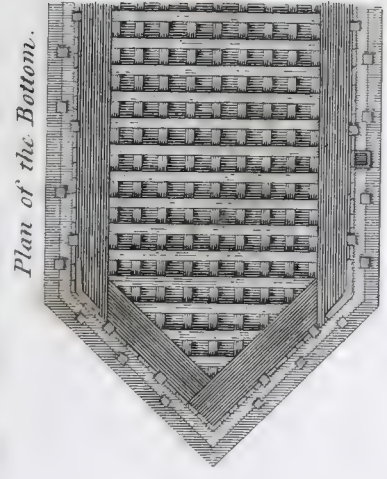


Scale of feet for Fig. 1, 2, 3, 4.

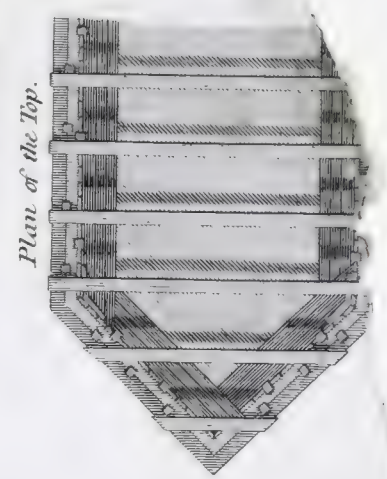
Transverse Section. Fig. 3.



Plan of the Caisson & Pier when Fixed. Fig. 4.



Plan of the Bottom.



Plan of the Top.

W. & A. PIERCE DEL.



CENTRES.

OF BLACKFRIARS BRIDGE, AT LONDON.



OF WESTMINSTER BRIDGE, AT LONDON.



OF NEUILLY BRIDGE, NEAR PARIS.



OF THE BRIDGE AT ORLEANS, IN FRANCE.



10 20 30 40 50 60 70 80 90 100 feet

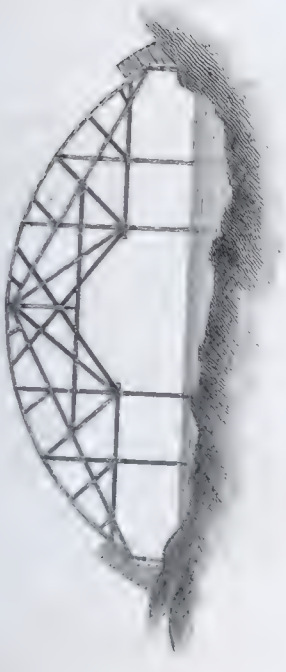
W. BUNESS SC.



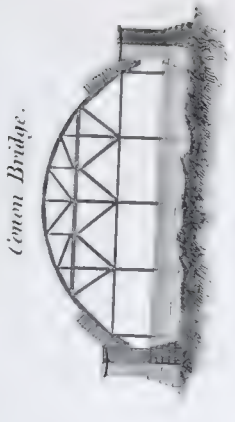
**BRIDGE.  
CENTERS.**



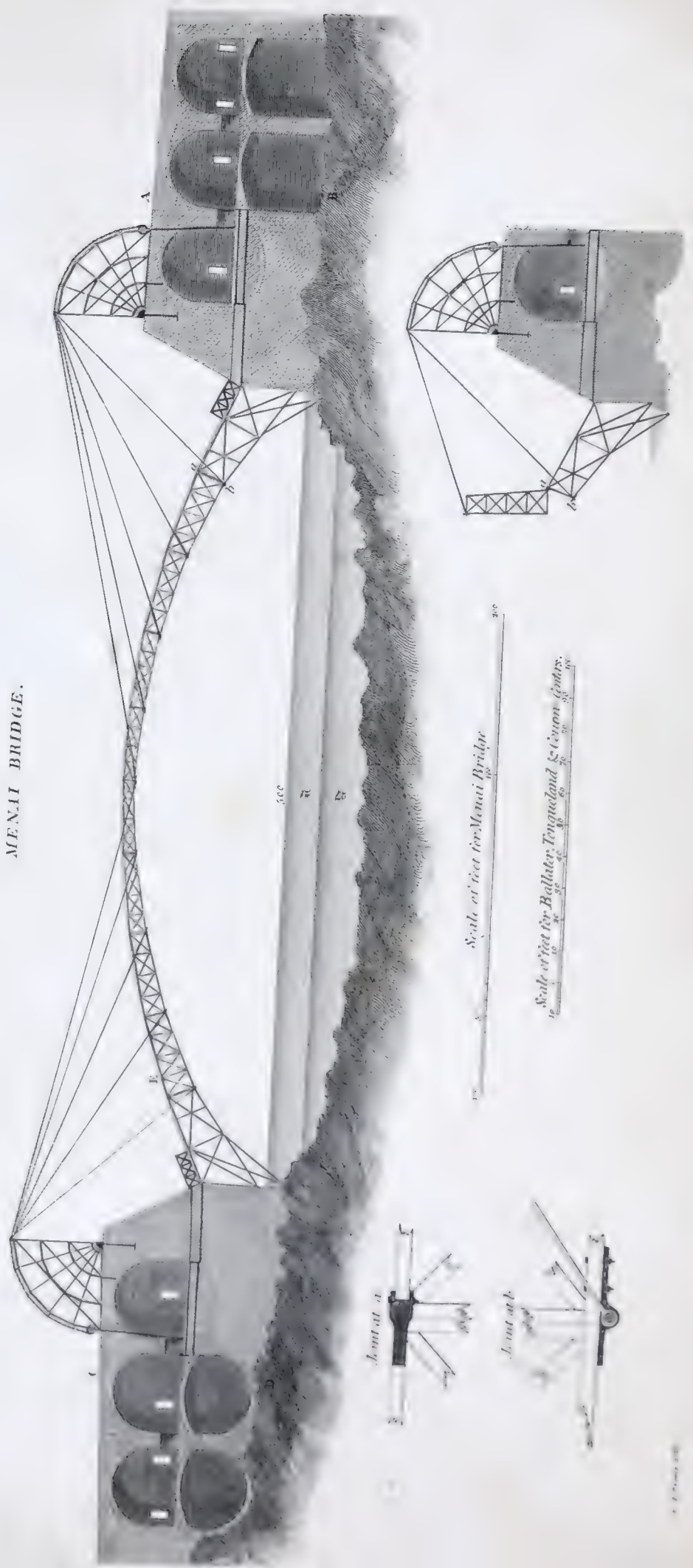
*Ballater Bridge*



*Tongueland Bridge.*



*Cenon Bridge.*



**MENAI BRIDGE.**

*Scale of feet for Menai Bridge*

A horizontal scale bar with markings every 10 feet, ranging from 0 to 100 feet.

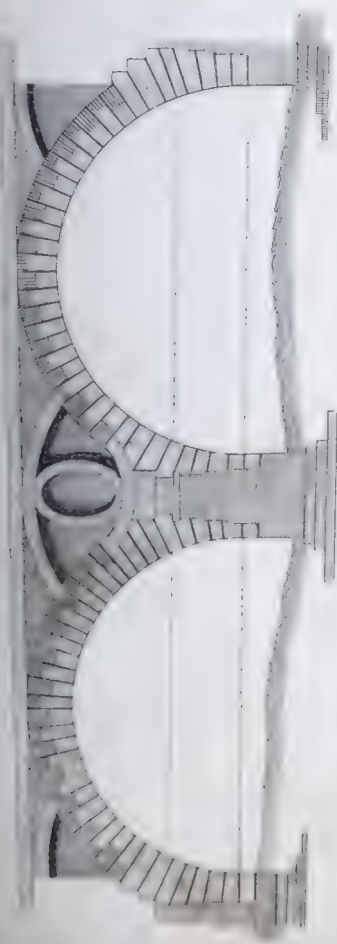
*Scale of feet for Ballater, Tongueland & Cenon Centers.*

A horizontal scale bar with markings every 10 feet, ranging from 0 to 100 feet.





SECTIONS



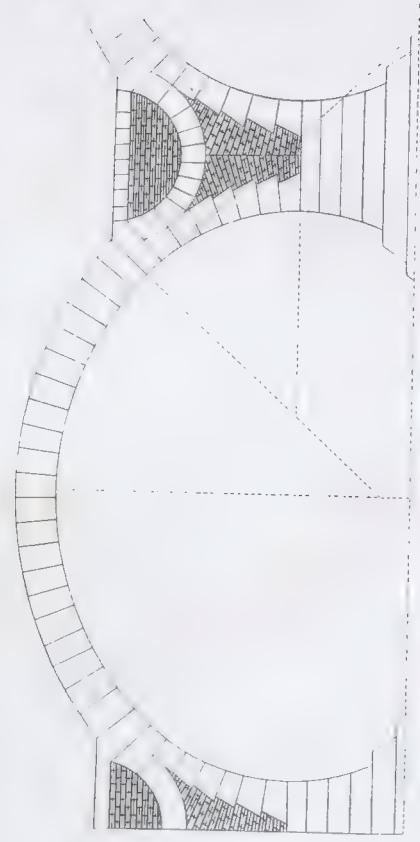
*The south Pier of Westminster Bridge*



*Westminster Bridge*



*Orleans Bridge*



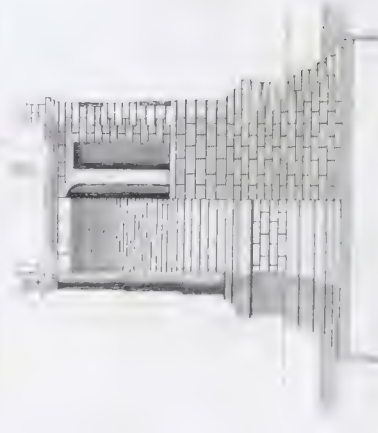
*Blackfriars Bridge*

Scale of Feet for Westminster, Dunkirk & Blackfriars

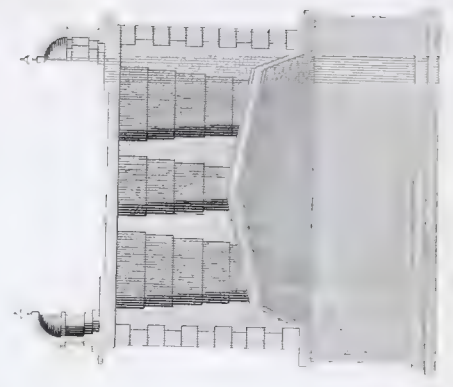
Scale of Feet for Orleans



*Lambeth Bridge*



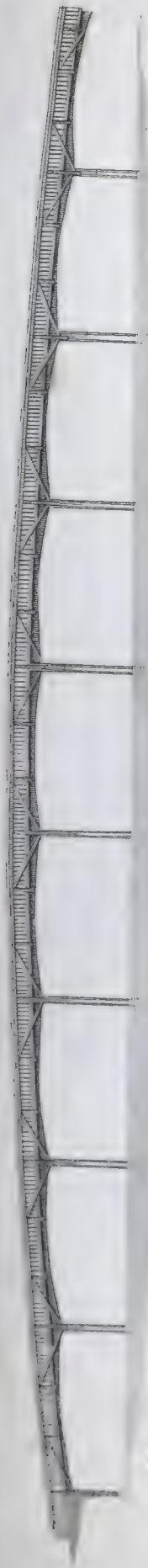
*Lambeth Bridge*



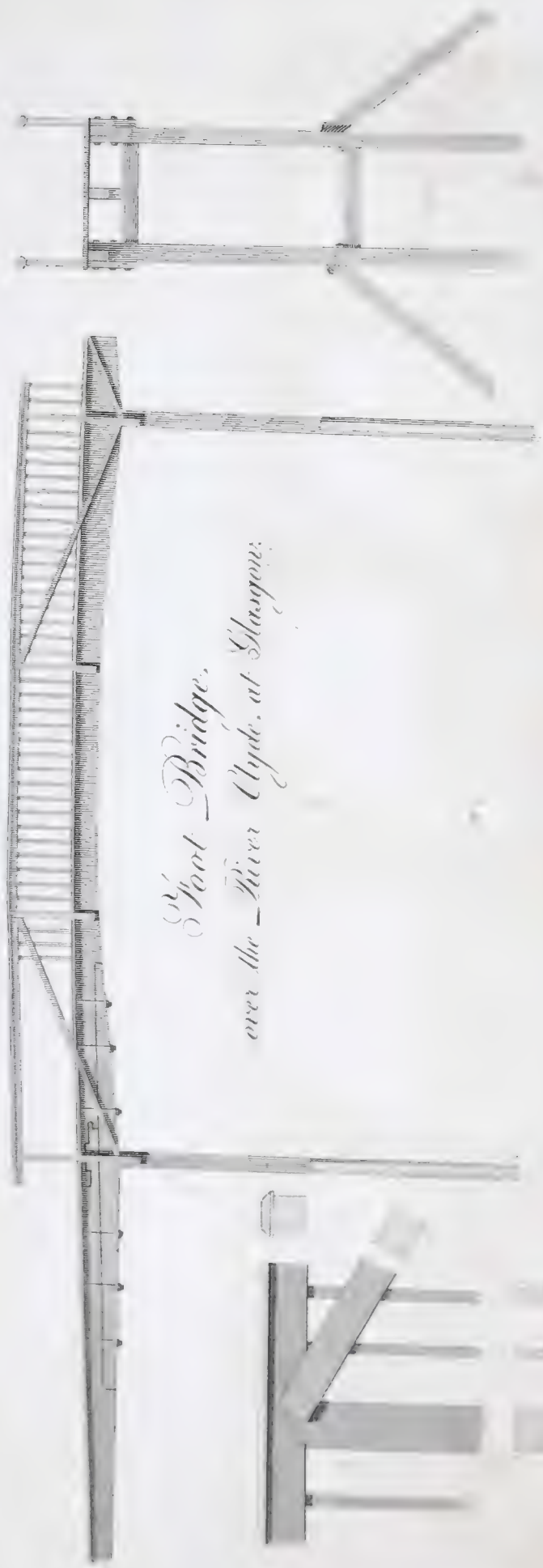
*Westminster Bridge*

*J. Thackeray sculpt.*

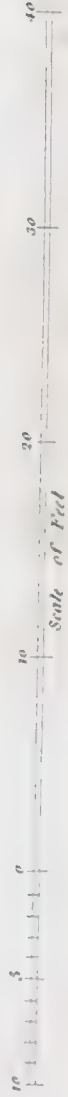




Scale of Feet



*W'ool Bridge,  
over the River Clyde, at Glasgow.*



Scale of Feet







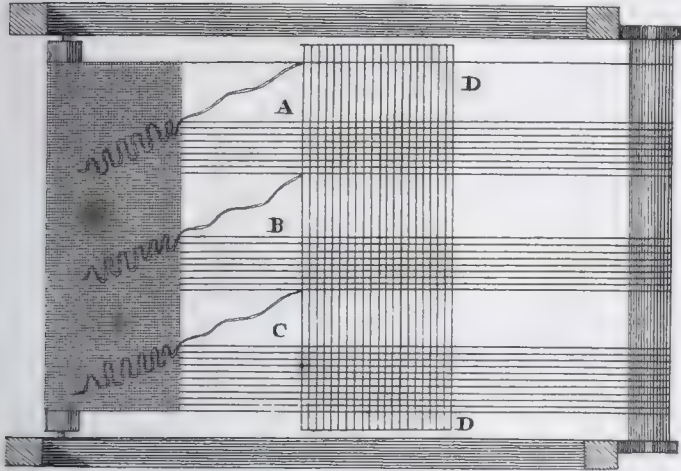
# BROCADE.

# PLATE CIV.

## BROCADING IN THE LOOM AND SPOTTING.

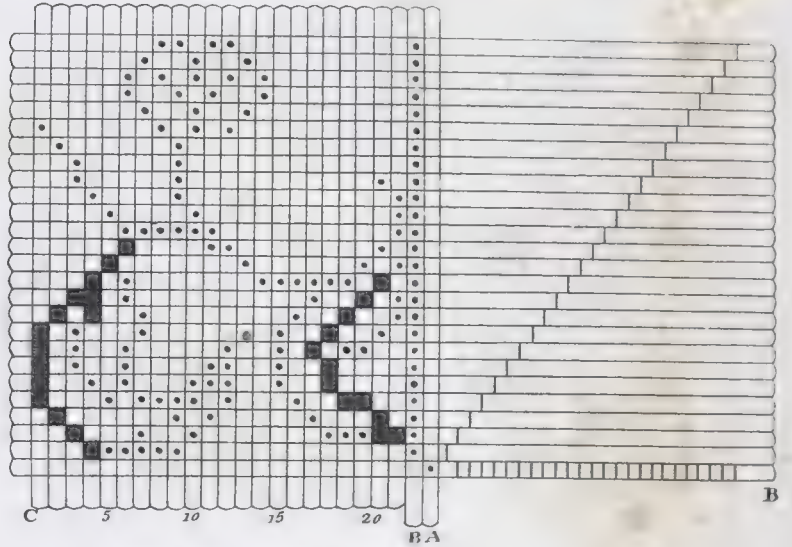
GENERAL PRINCIPLE.

Fig. 1.



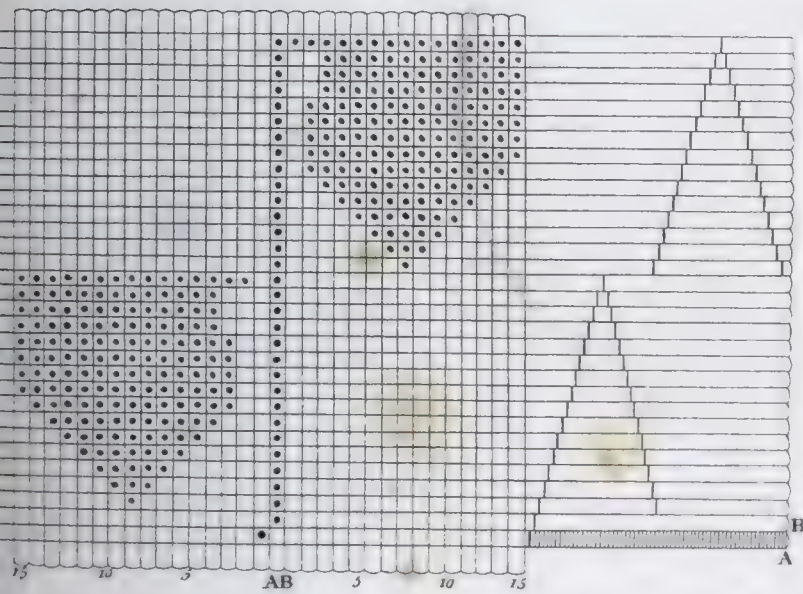
DRAUGHT AND CORDING.

Fig. 2.



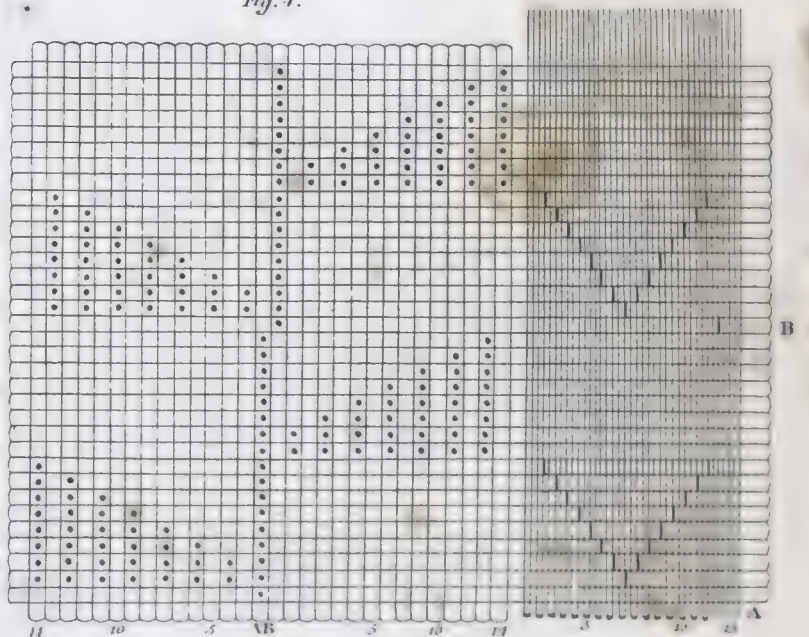
COMMON SPOTTING.

Fig. 3.



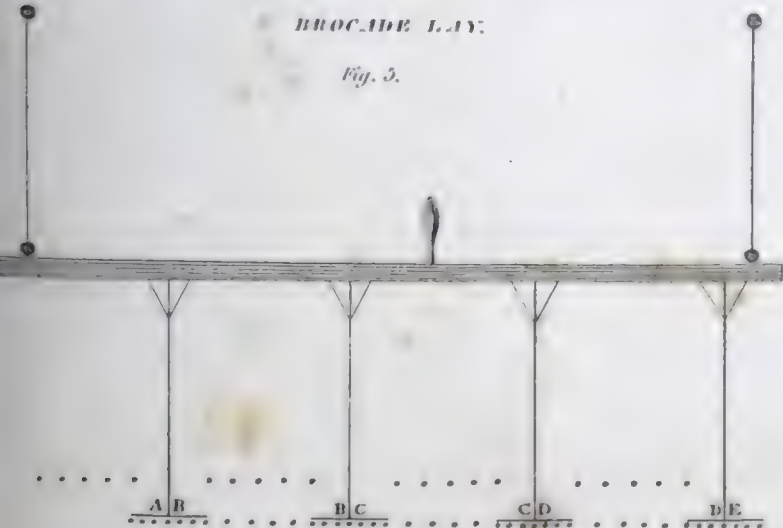
JAPAN OR PAPER SPOT.

Fig. 4.



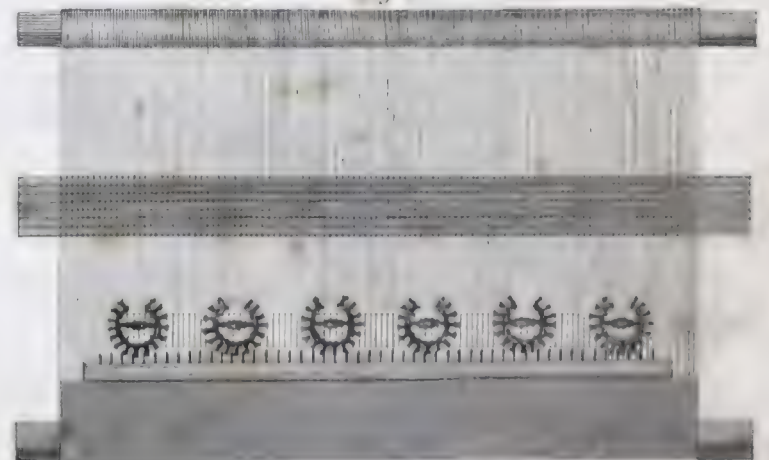
BROCADE LAY.

Fig. 5.



BROCADE SEGMENTS.

Fig. 6.







# BURNING INSTRUMENTS.

PLATE CV.

Fig. 5.

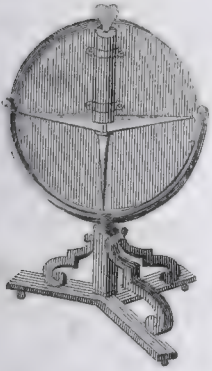


Fig. 1



Fig. 7.

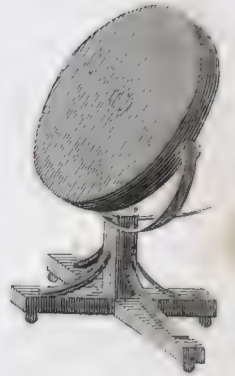


Fig. 6.



Fig. 8.



Fig. 2.

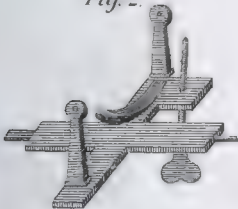


Fig. 3.

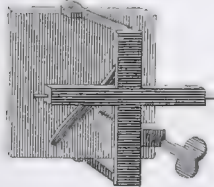


Fig. 4.

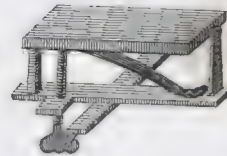


Fig. 9.

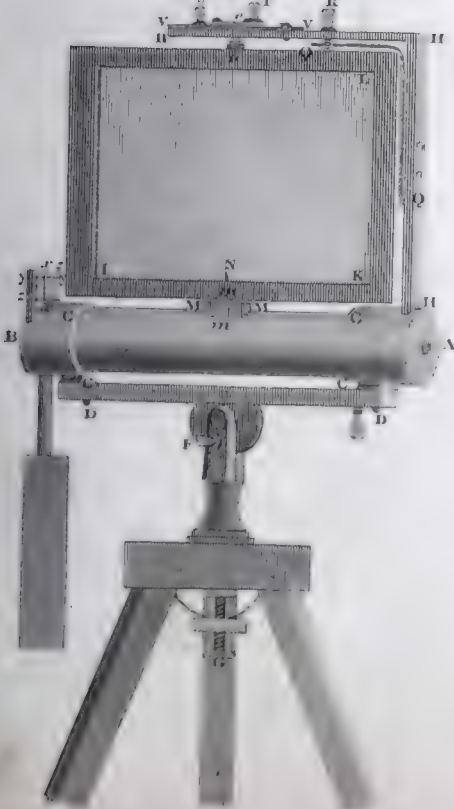


Fig. 10.

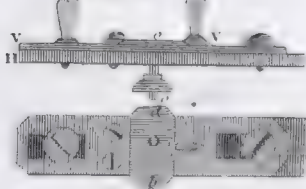


Fig. 11.





Fig. 1.

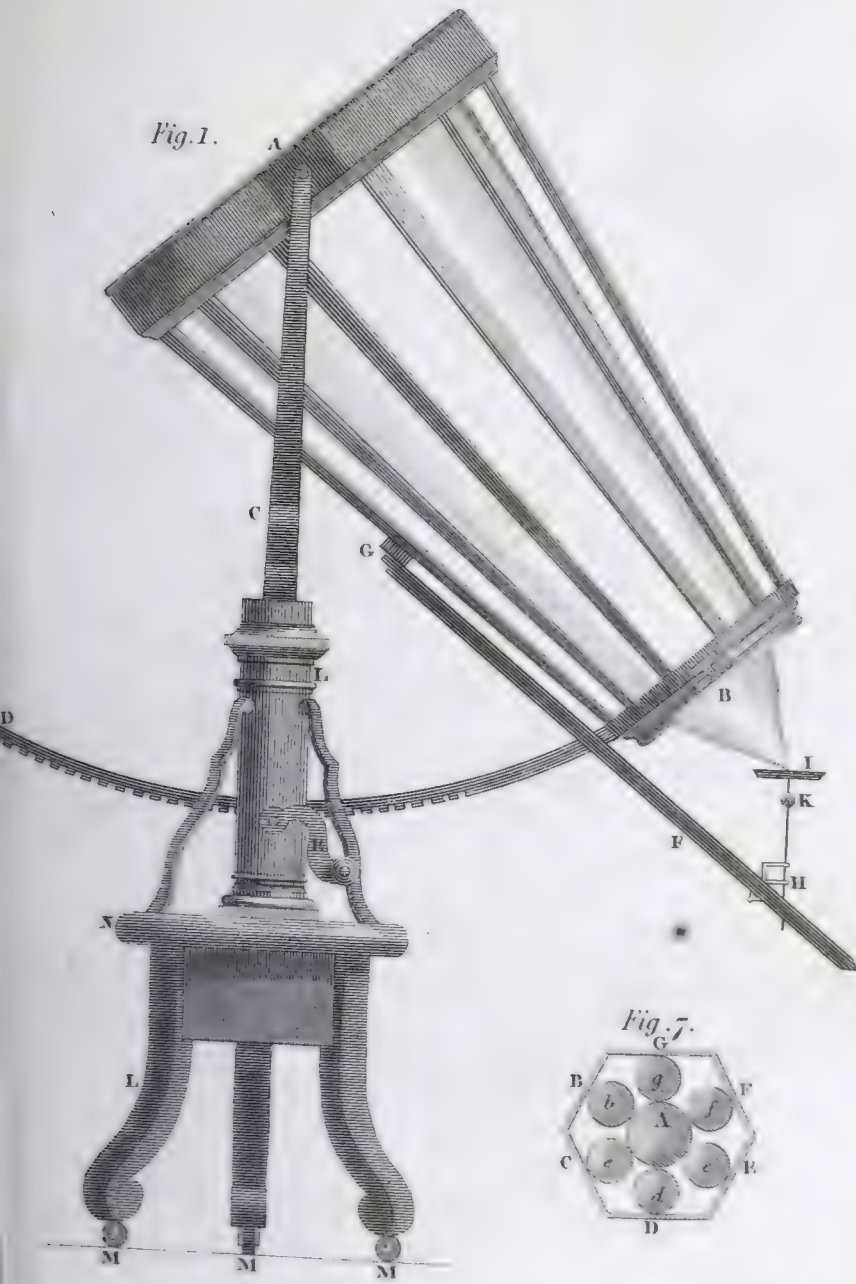


Fig. 2.



Fig. 3.



Fig. 4.



Fig. 5.

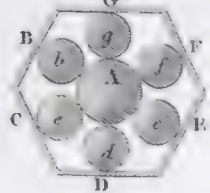


Fig. 6.



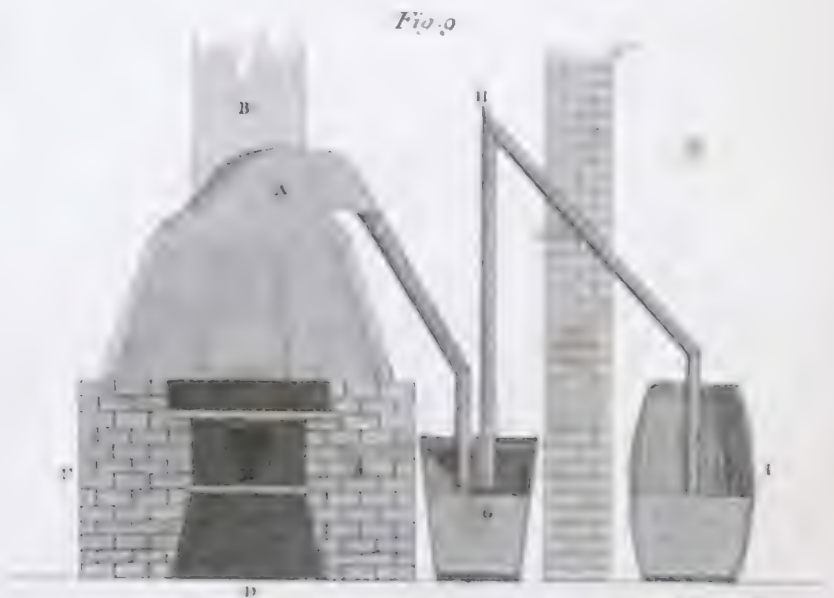
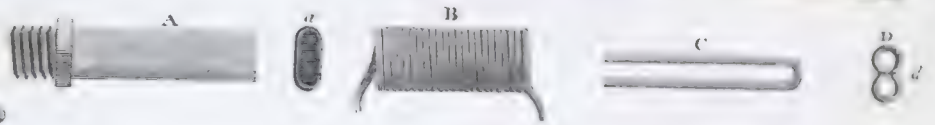
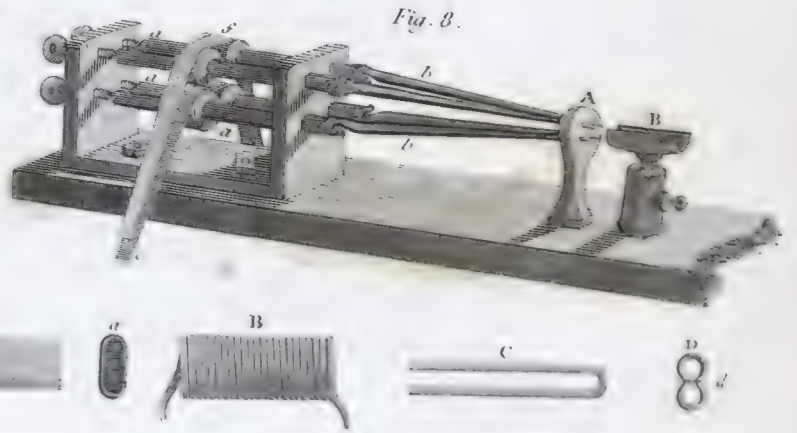
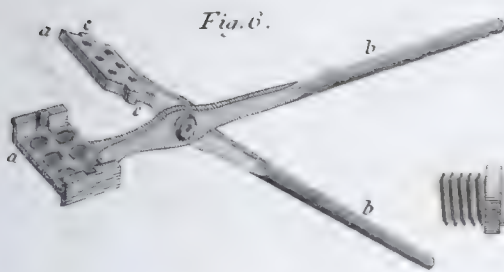
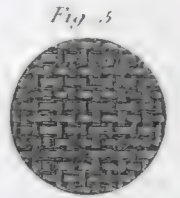
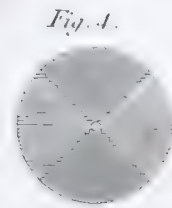
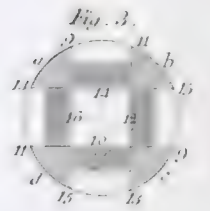
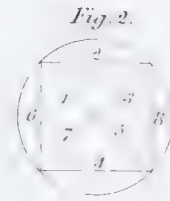
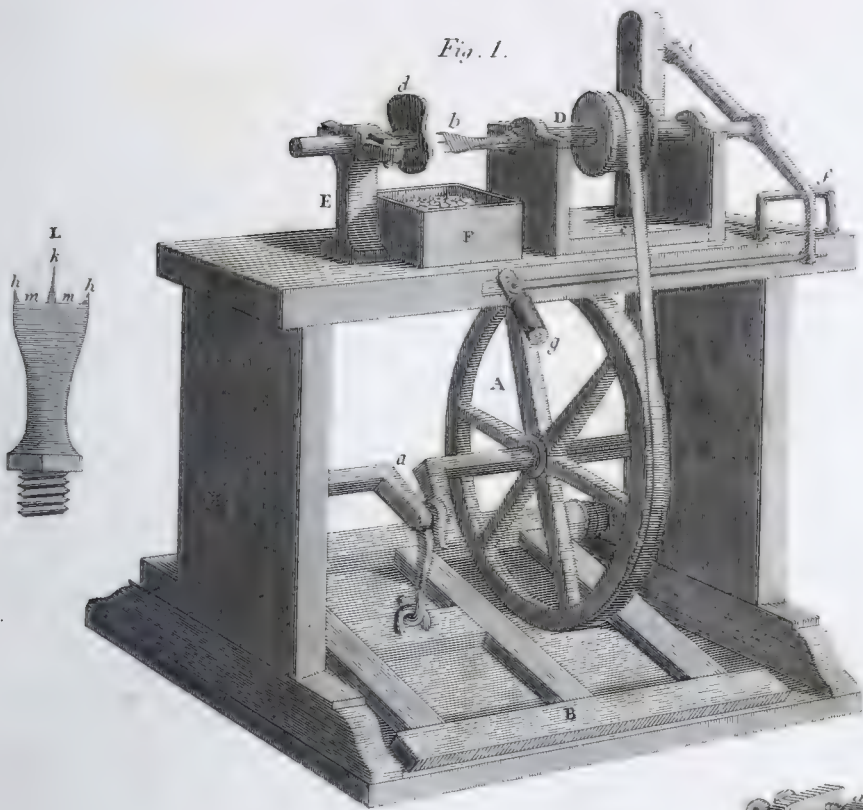
Fig. 7.





BUTTON MAKING.

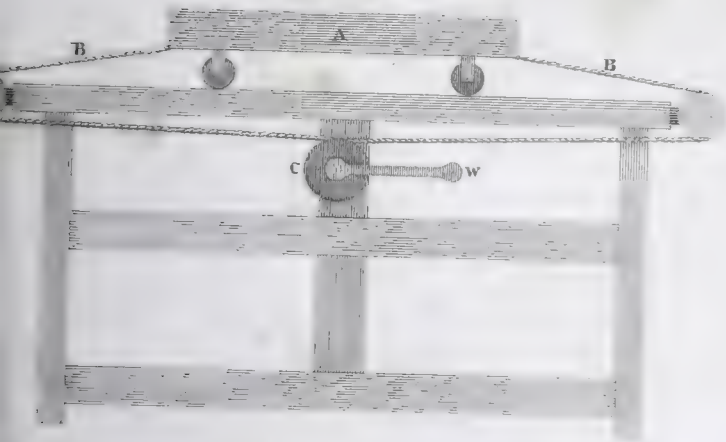
PLATE CVII.





COMMON MANGLE.

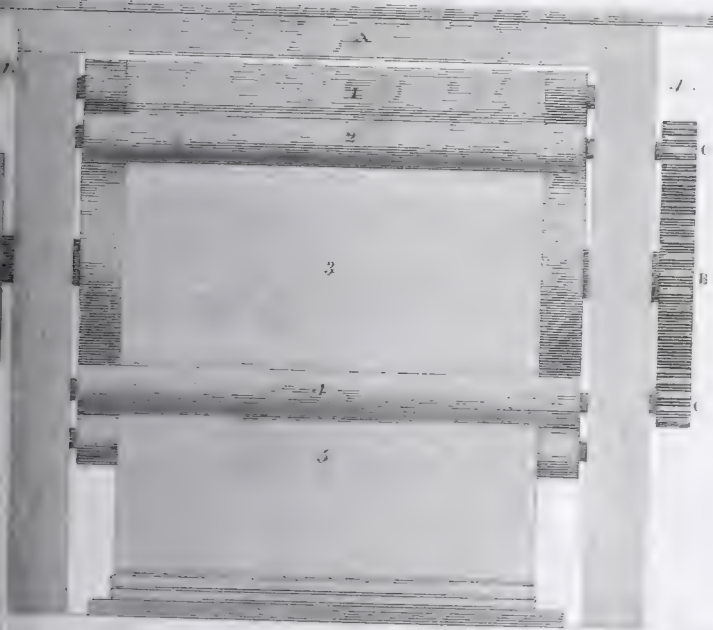
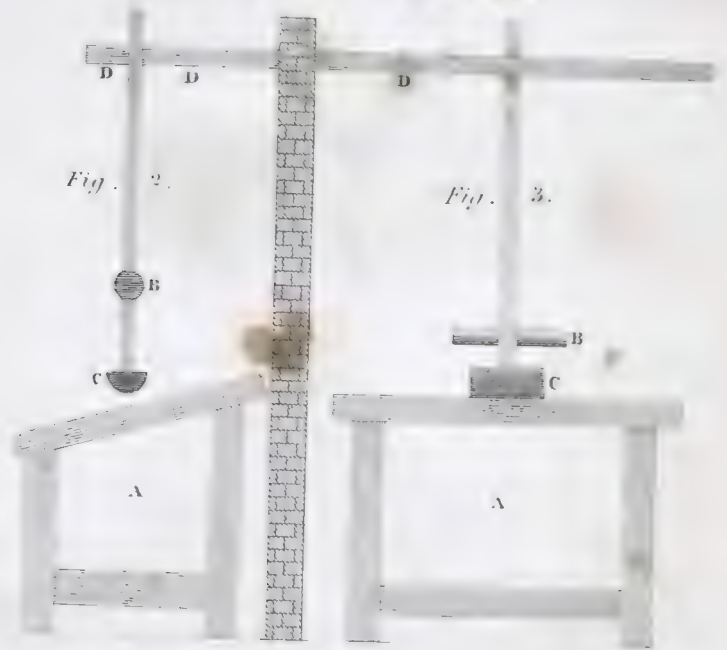
Fig. 1.



GLAZING TABLE.

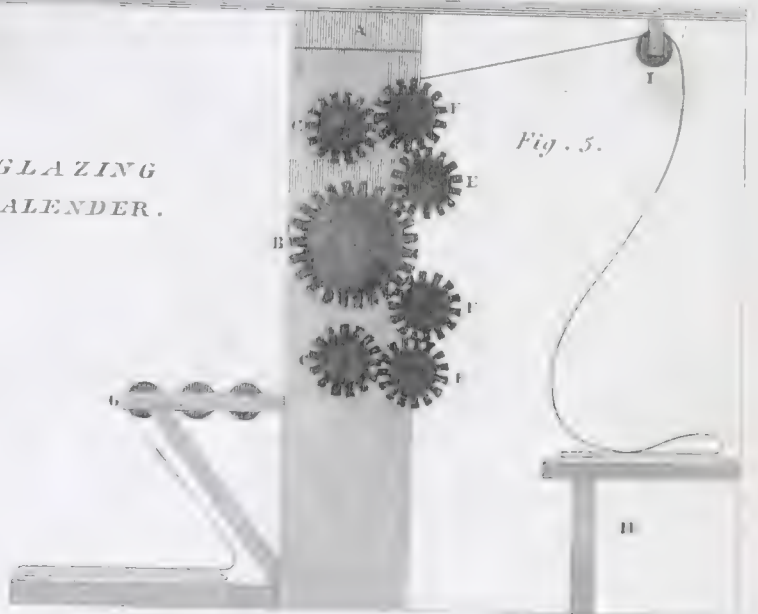
Fig. 2.

Fig. 3.



GLAZING CALENDER.

Fig. 5.



WATER PRESS.

Fig. 6.



MUSLIN CALENDER

Fig. 7.







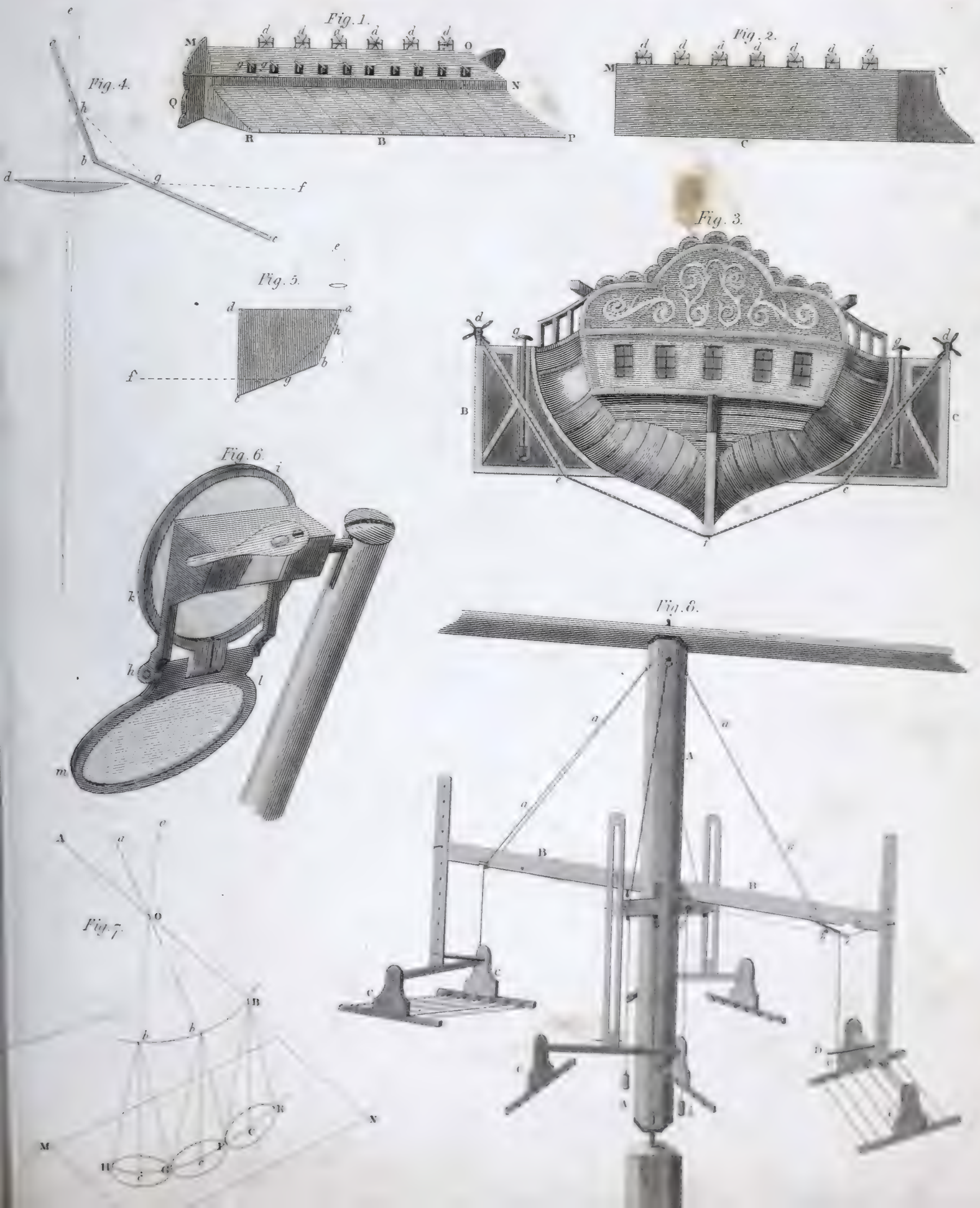




Fig. 1.



Fig. 2.

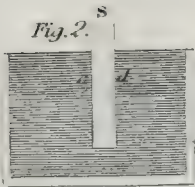


Fig. 3.



Fig. 4.

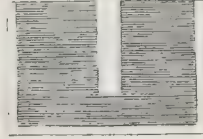


Fig. 6.

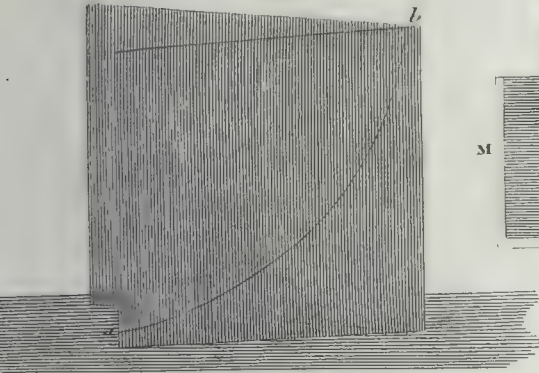


Fig. 5.

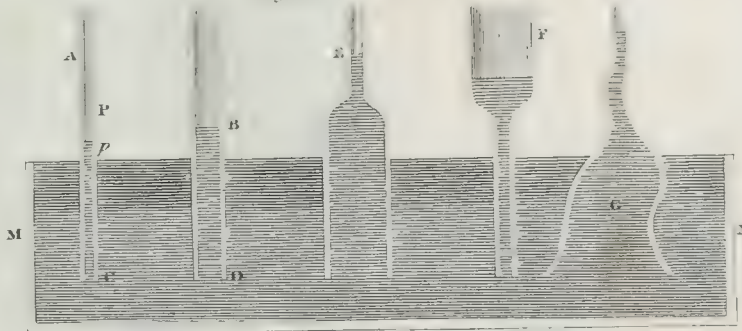


Fig. 8.



Fig. 10.

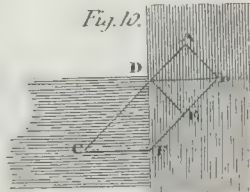


Fig. 11.

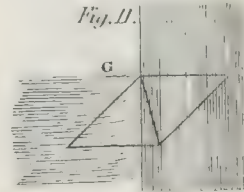


Fig. 12.

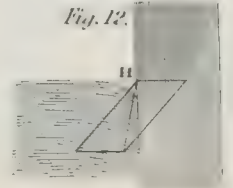


Fig. 7.

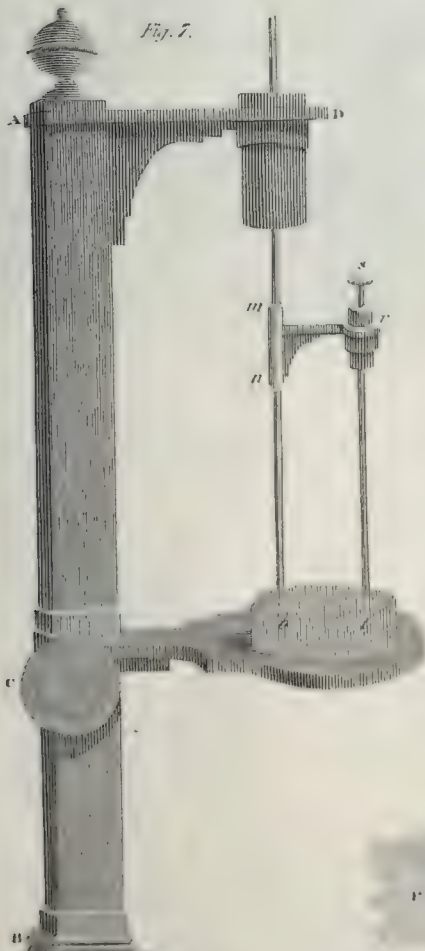


Fig. 7. A. 2.

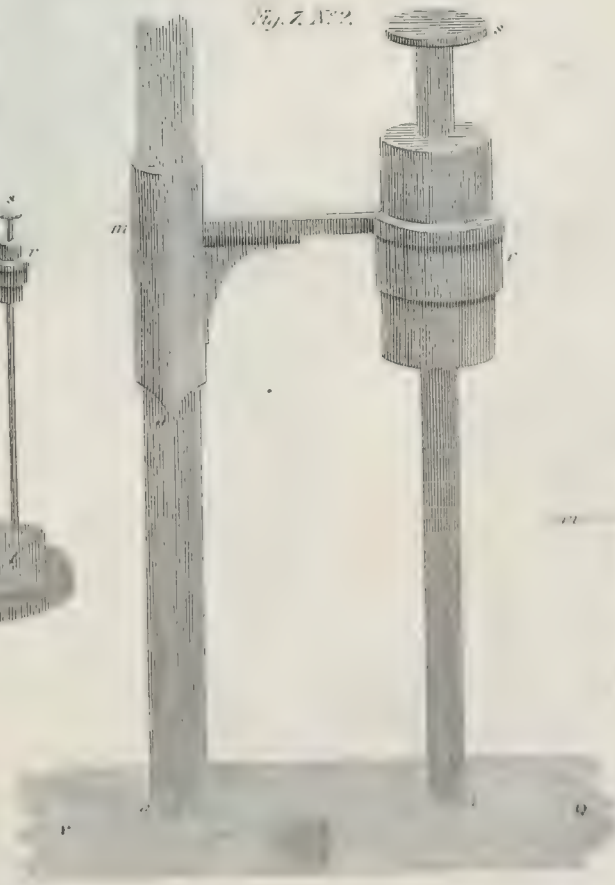
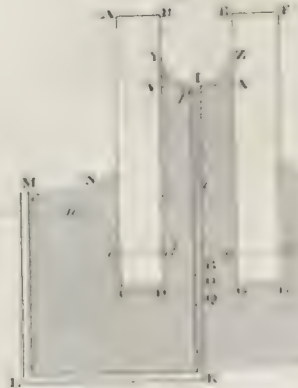
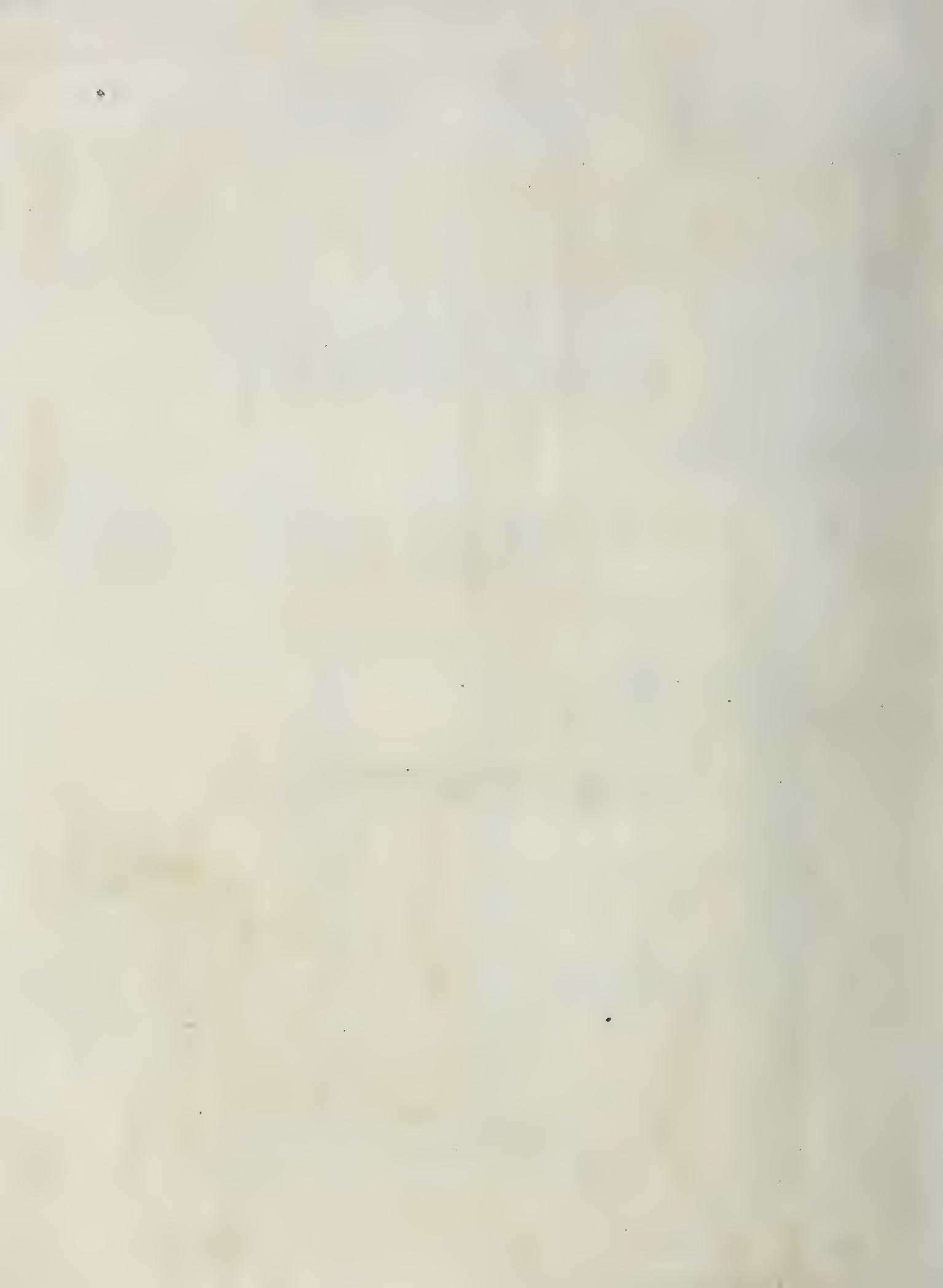


Fig. 9.





# CARD WIRE MACHINE.

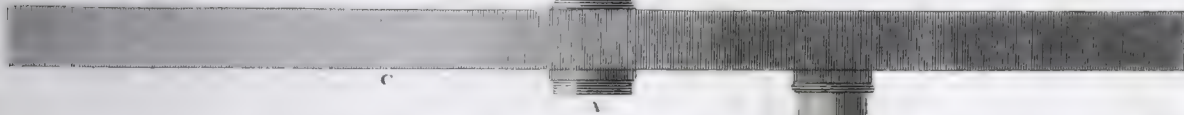
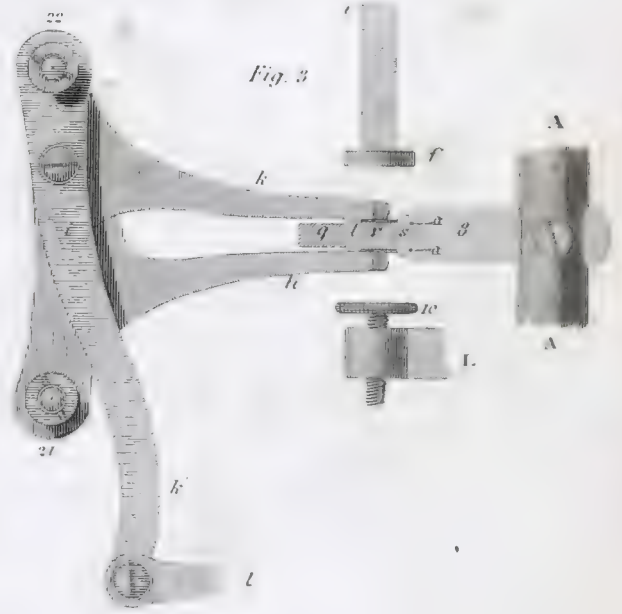
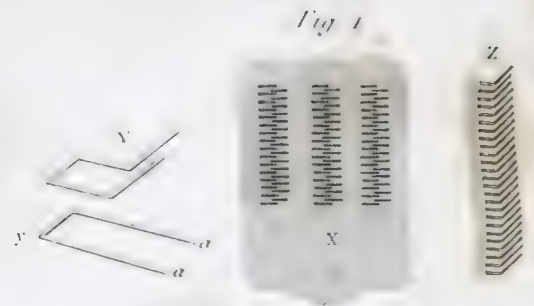
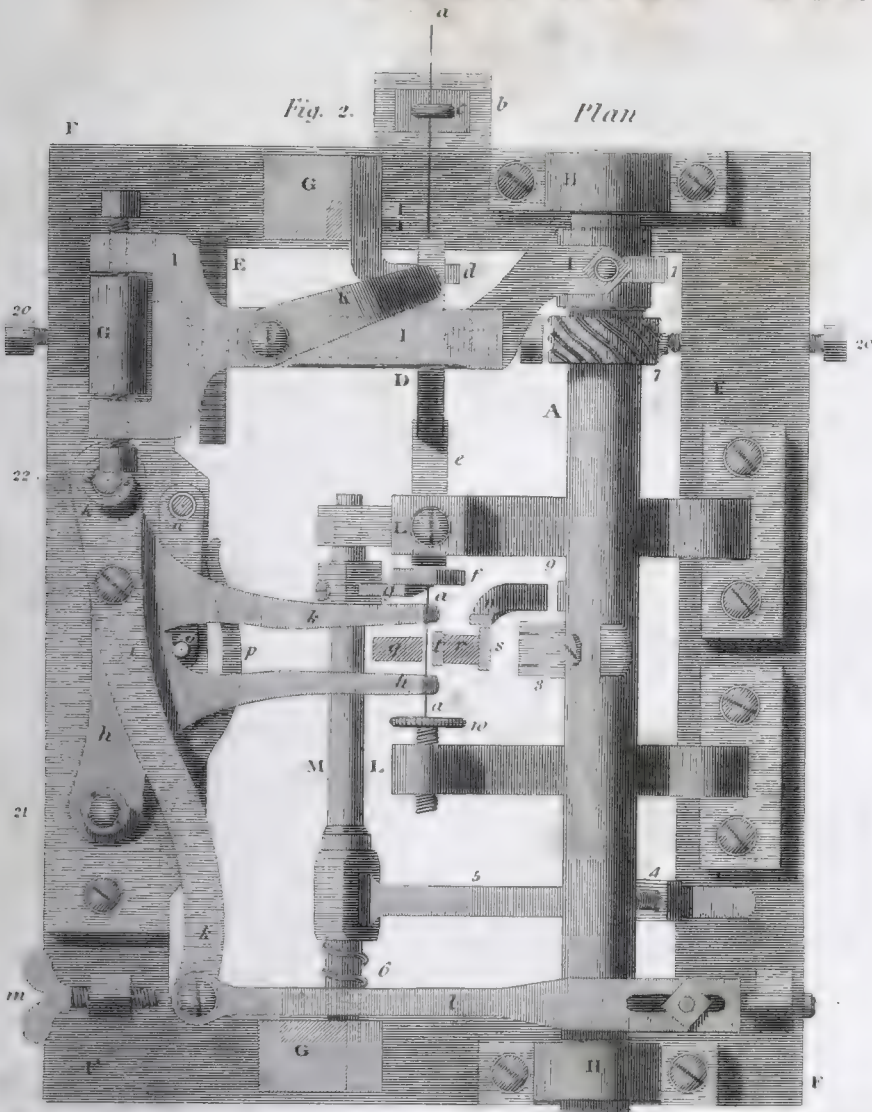
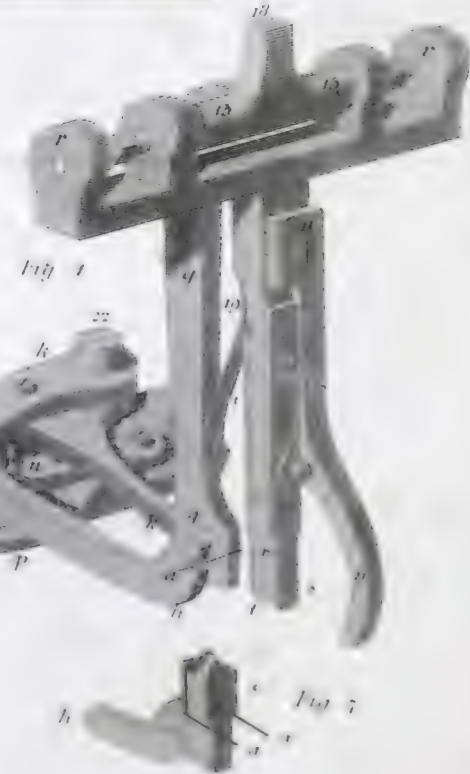
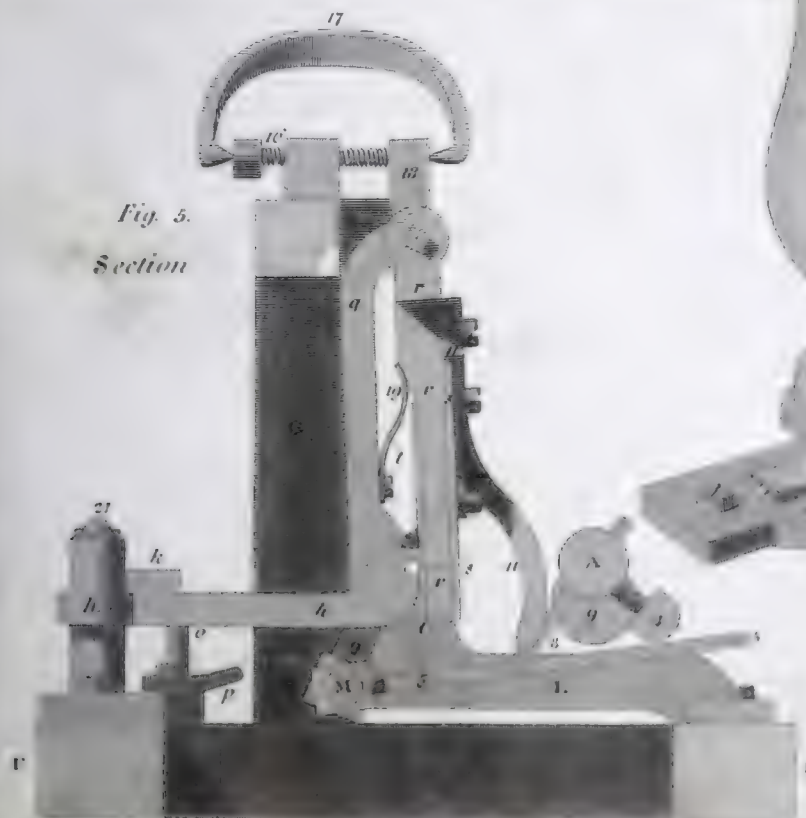


Fig. 5.  
Section





# CARPENTRY.

Fig. 1.

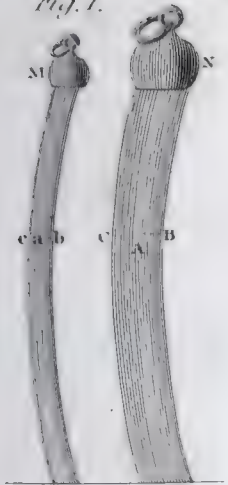


Fig. 2.

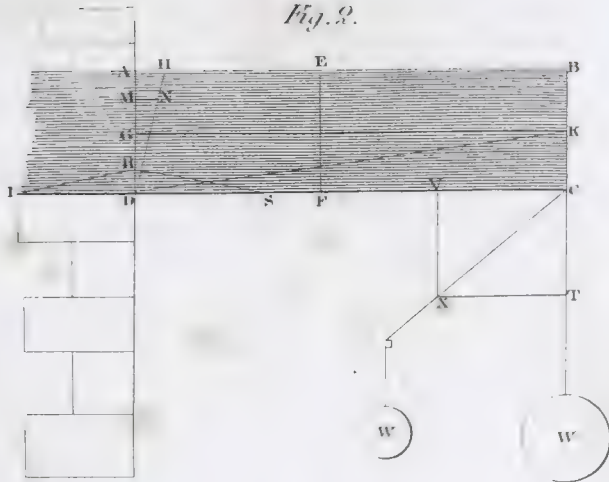


Fig. 3.

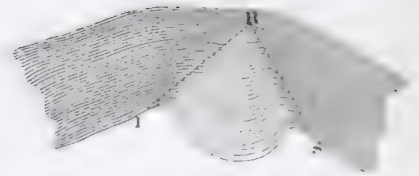


Fig. 5.

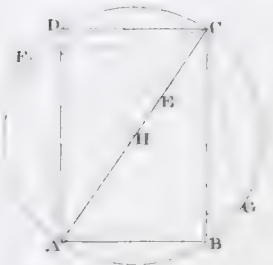


Fig. 4.



Fig. 6. N° 1.

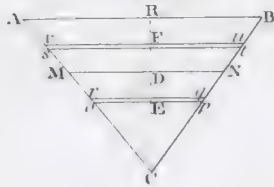


Fig. 6. N° 2.

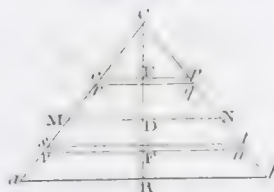


Fig. 7. N° 1.

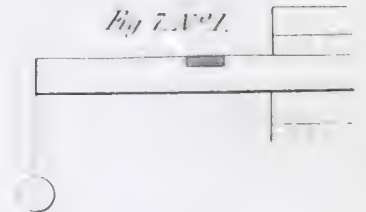


Fig. 7. N° 2.

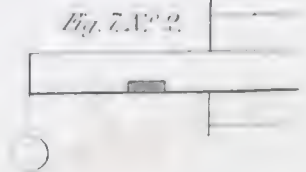


Fig. 7. N° 3.

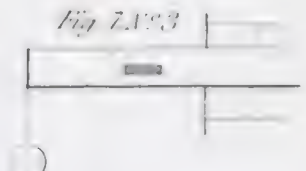


Fig. 7. N° 4.



Fig. 7. N° 5.

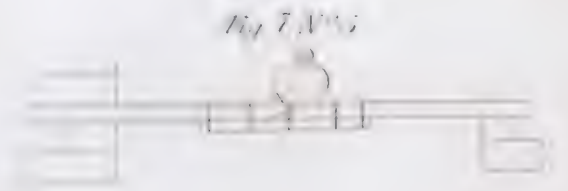


Fig. 9.

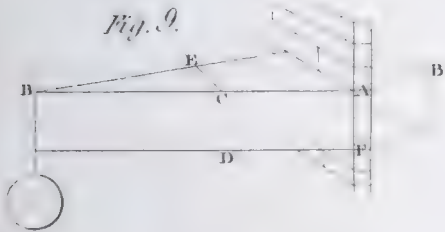


Fig. 10.

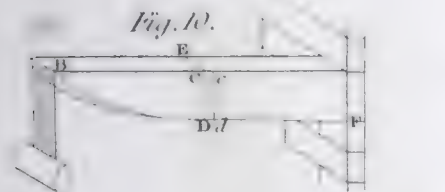


Fig. 11.

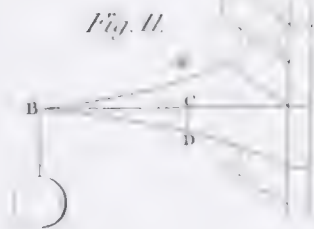


Fig. 8.







Fig. 2.

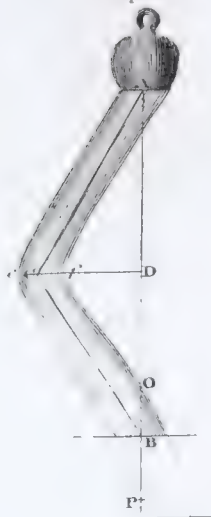


Fig. 3.



Fig. 4.

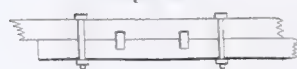


Fig. 1.

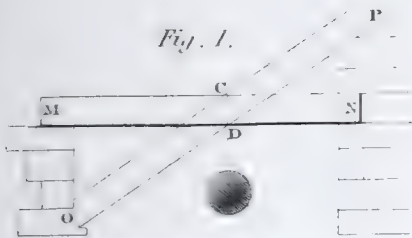


Fig. 5.



Fig. 8.



Fig. 6. N° 1.



Fig. 6. N° 2.



Fig. 9.



Fig. 10. N° 1.



Fig. 11. N° 1.



Fig. 12. N° 1.



Fig. 10. N° 2.



Fig. 11. N° 2.

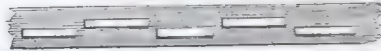


Fig. 13. N° 2.



Fig. 7. N° 1.



Fig. 11.



Fig. 7. N° 2.



Fig. 17. N° 1.



Fig. 15.

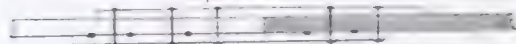


Fig. 17. N° 2.



Fig. 16.



Fig. 13.



Fig. 18.

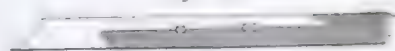


Fig.



Fig. 17. N° 3.



Fig. 19.





# CARPENTRY.

## GEOMETRICAL PRINCIPLES.

Fig. 1.

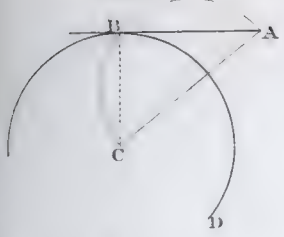


Fig. 7.

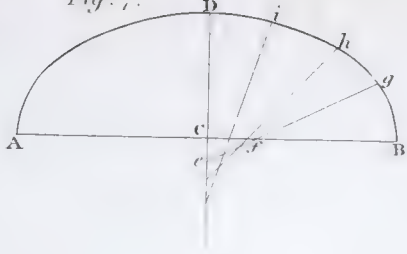


Fig. 4.

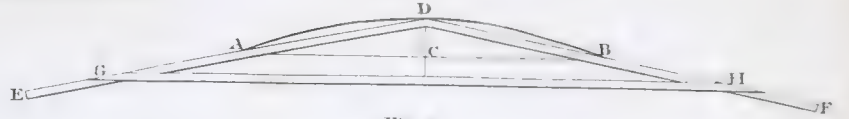


Fig. 5.

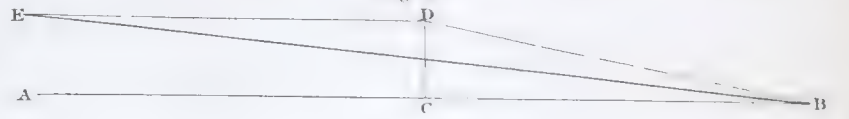


Fig. 6.



Fig. 2.

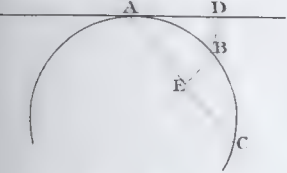


Fig. 3.

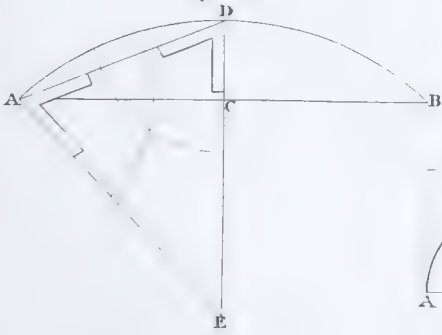


Fig. 8.



Fig. 9.

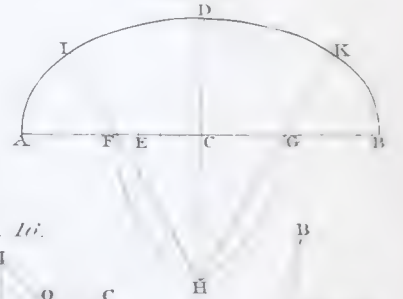


Fig. 10.

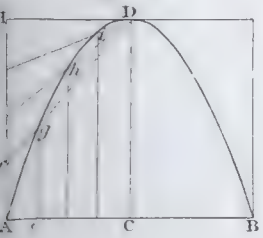


Fig. 11.

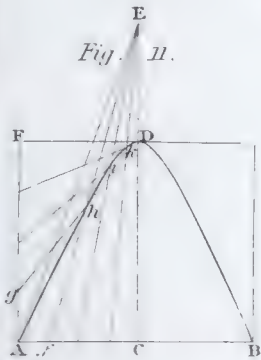


Fig. 12.

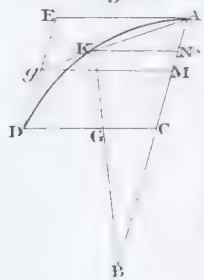


Fig. 15.

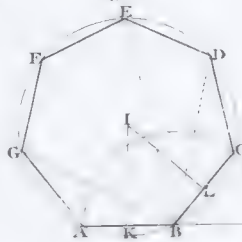


Fig. 16.

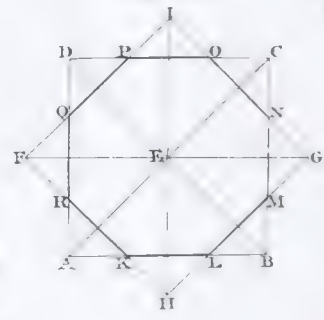


Fig. 13.

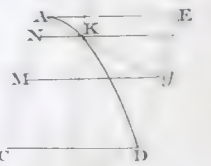


Fig. 14.

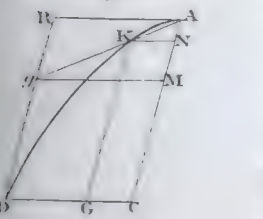


Fig. 19.

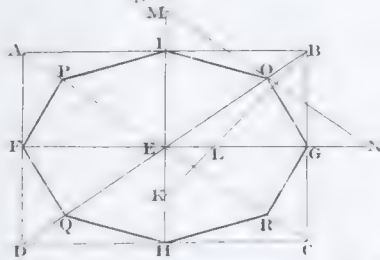


Fig. 20.

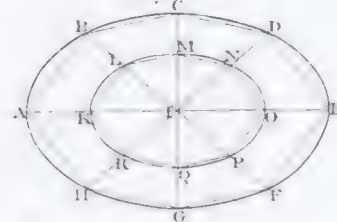


Fig. 21.

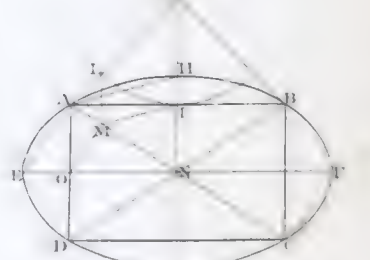


Fig. 18.

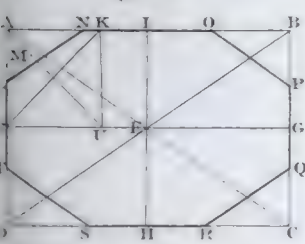


Fig. 17.

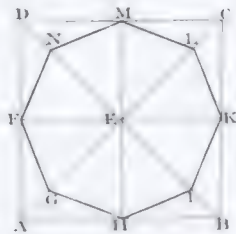


Fig. 25.

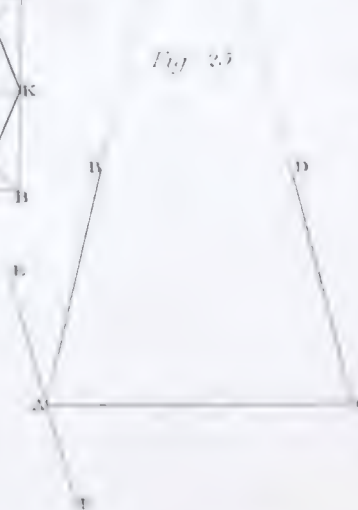


Fig. 23 N°1.



Fig. 23 N°2.



Fig. 24 N°1.

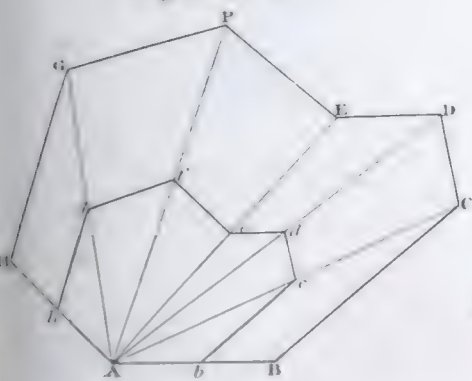


Fig. 24 N°2.



Fig. 22.





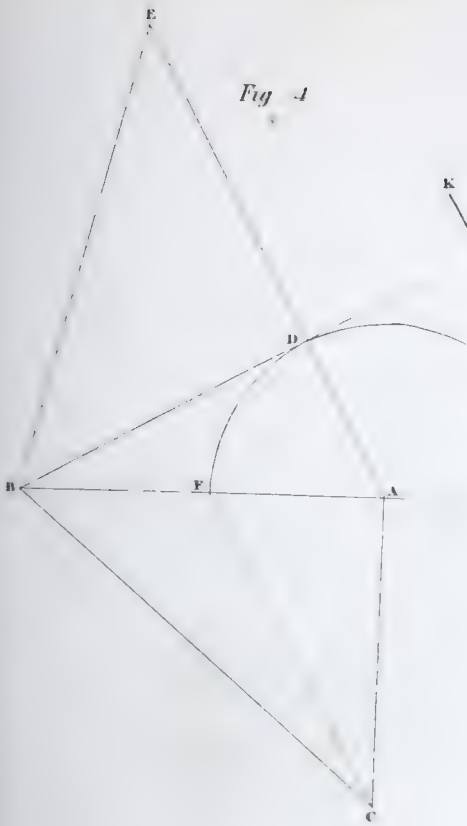


Fig. 4

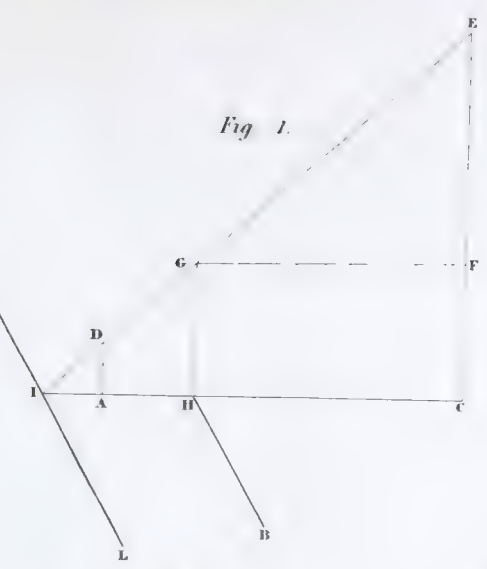


Fig. 1

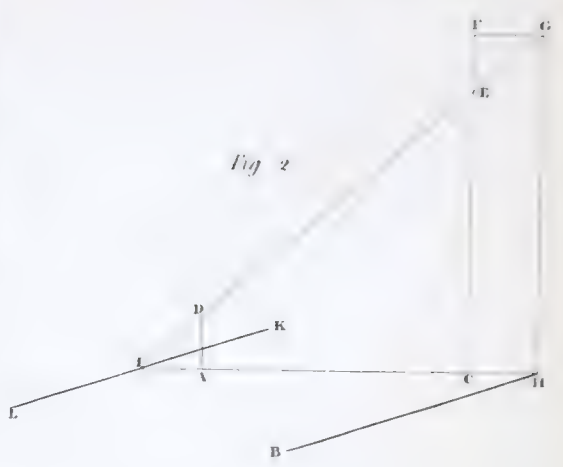


Fig. 2

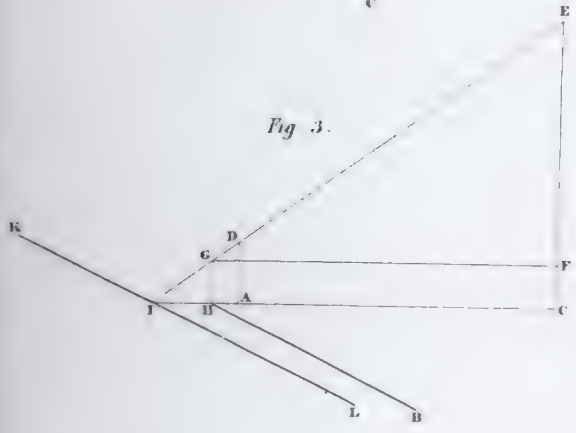


Fig. 3



Fig. 6

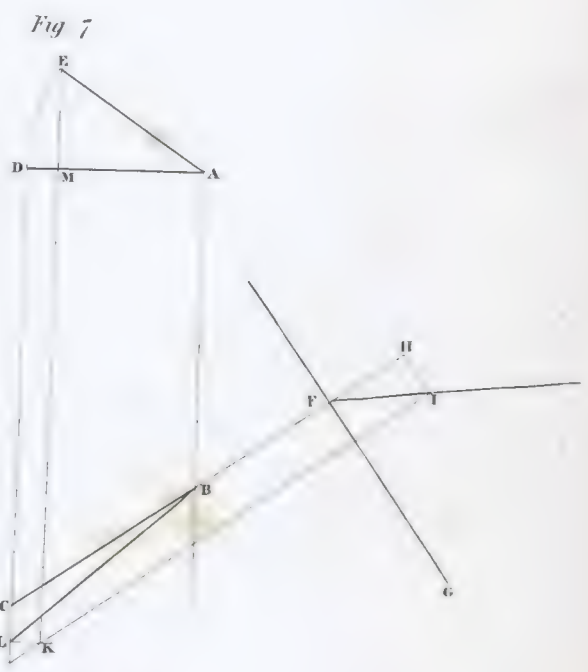


Fig. 7

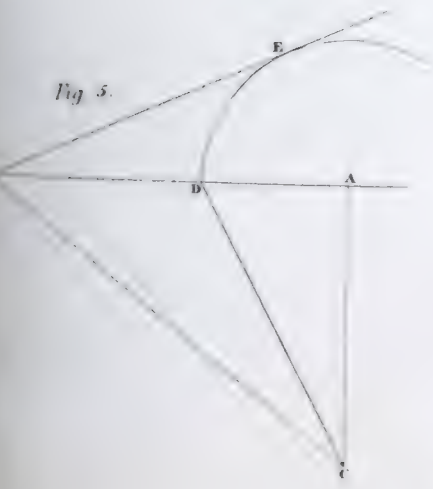


Fig. 5



Fig. 8

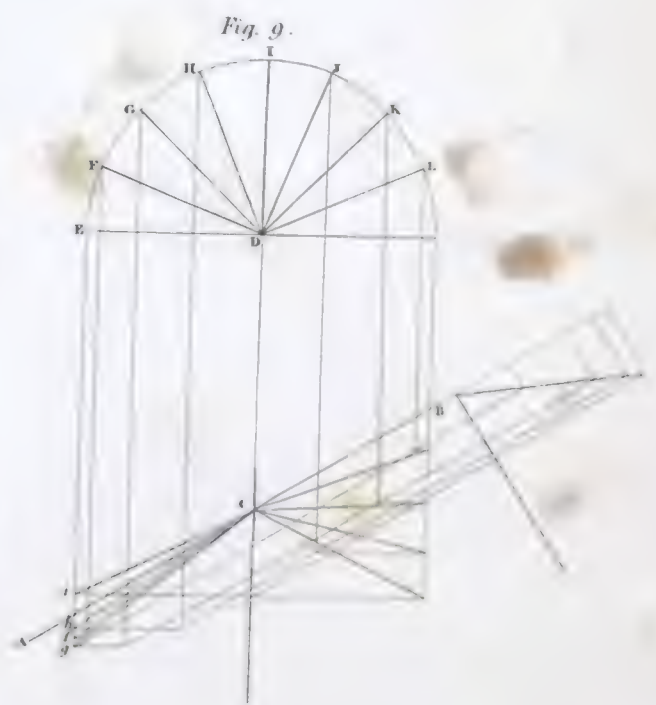


Fig. 9



Fig. 1.

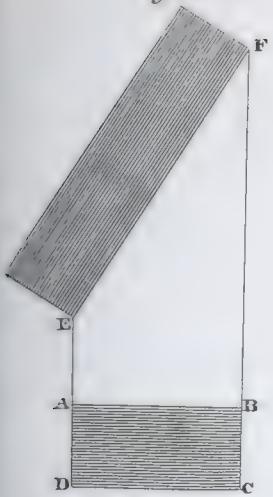


Fig. 2.

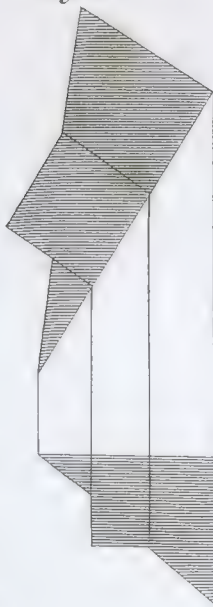


Fig. 3.



Fig. 4.

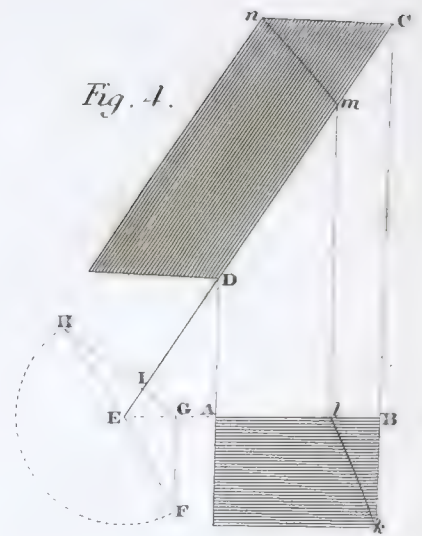


Fig. 5.

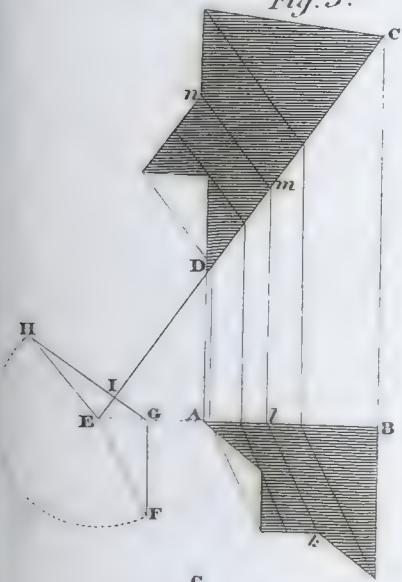


Fig. 7.

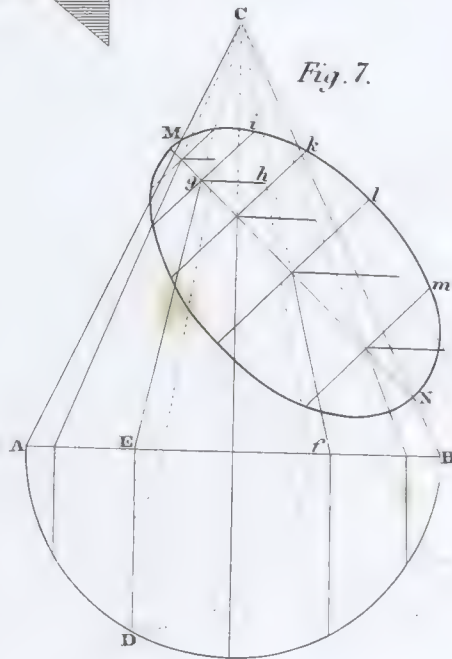


Fig. 6.

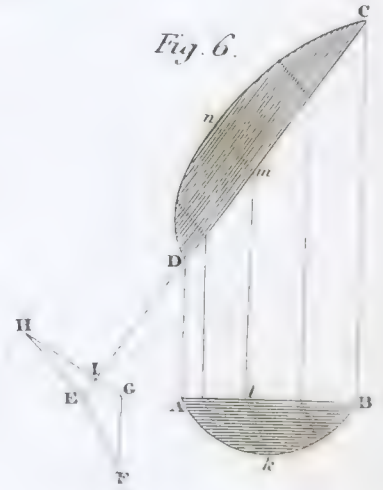


Fig. 9.

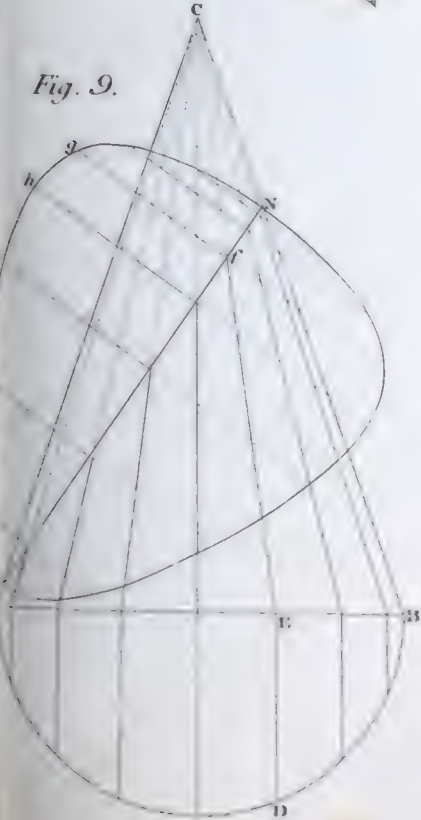


Fig. 8.

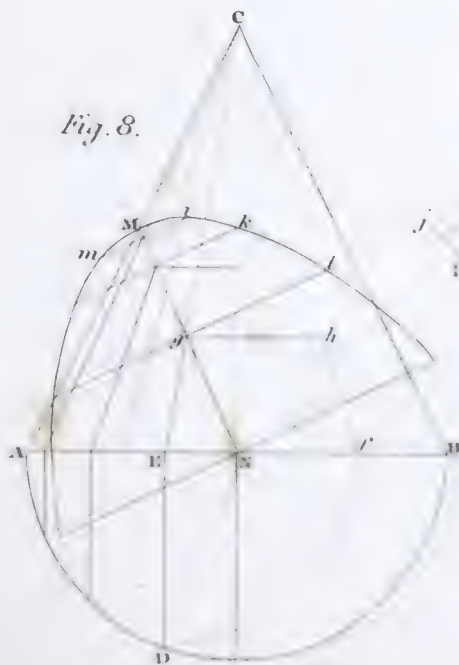
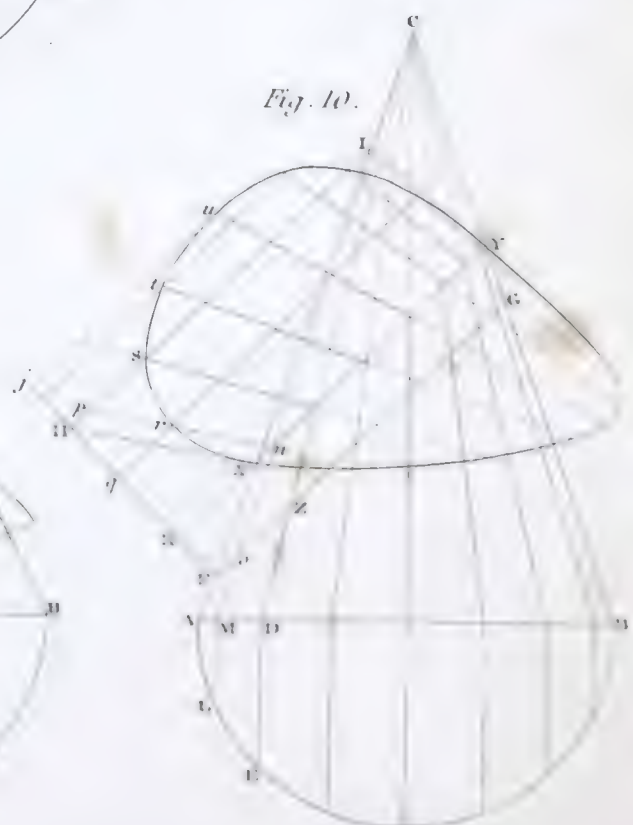
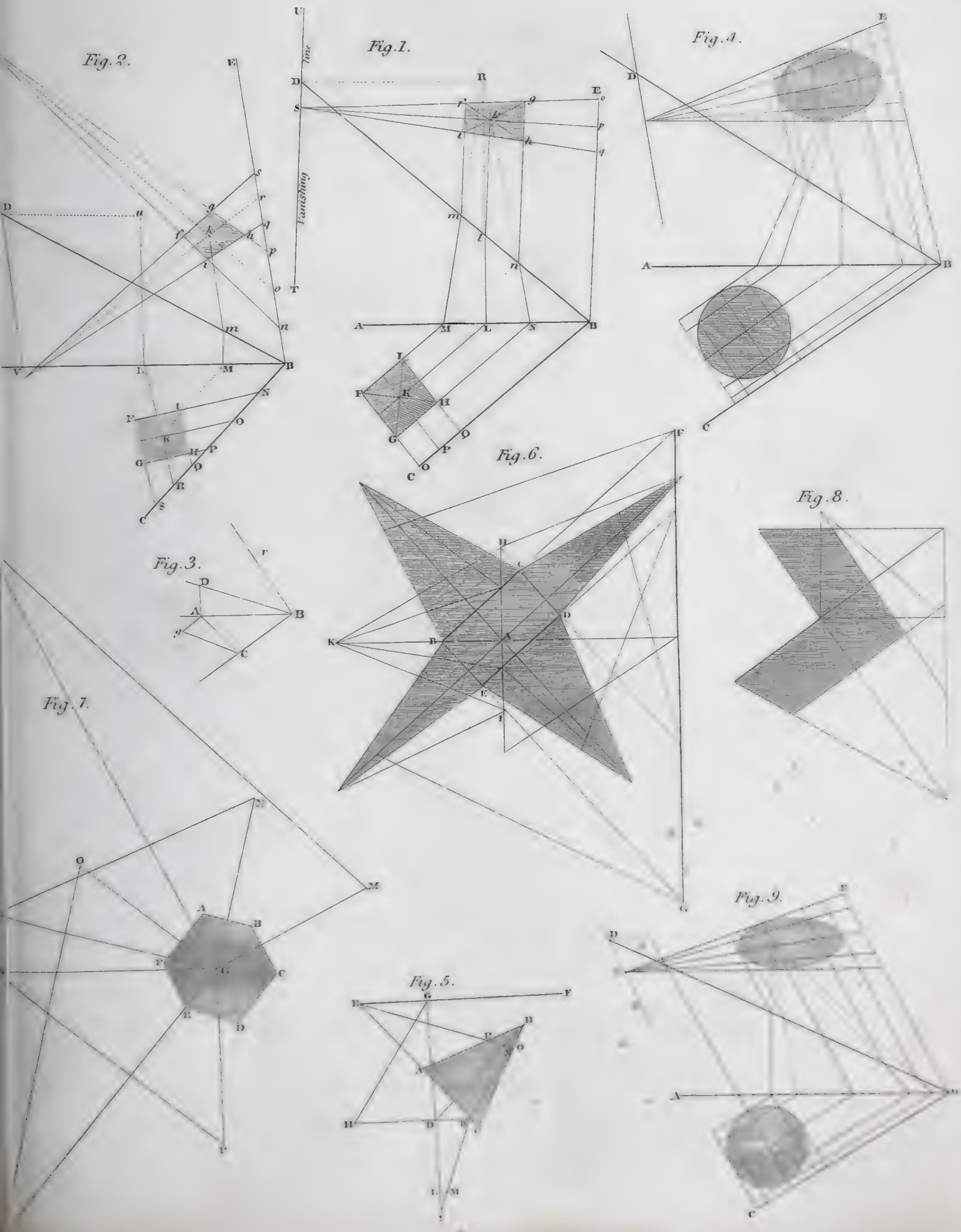


Fig. 10.











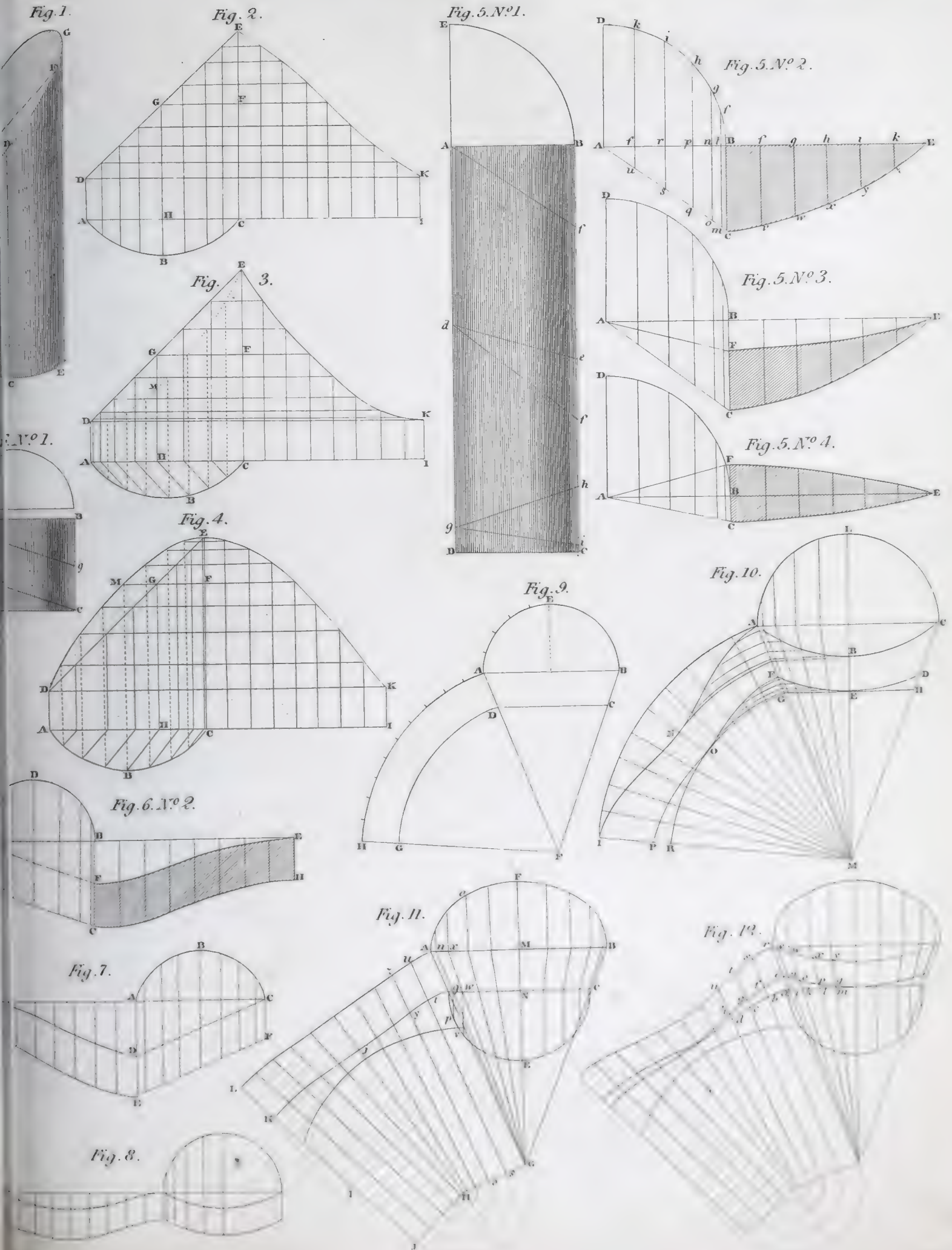




Fig. 1. N° 2.

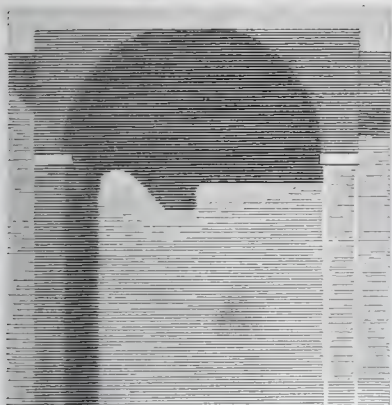


Fig. 1. N° 1

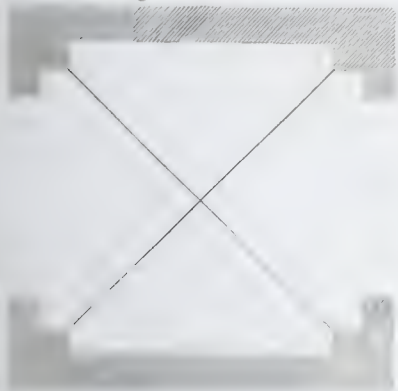


Fig. 2. N° 2.

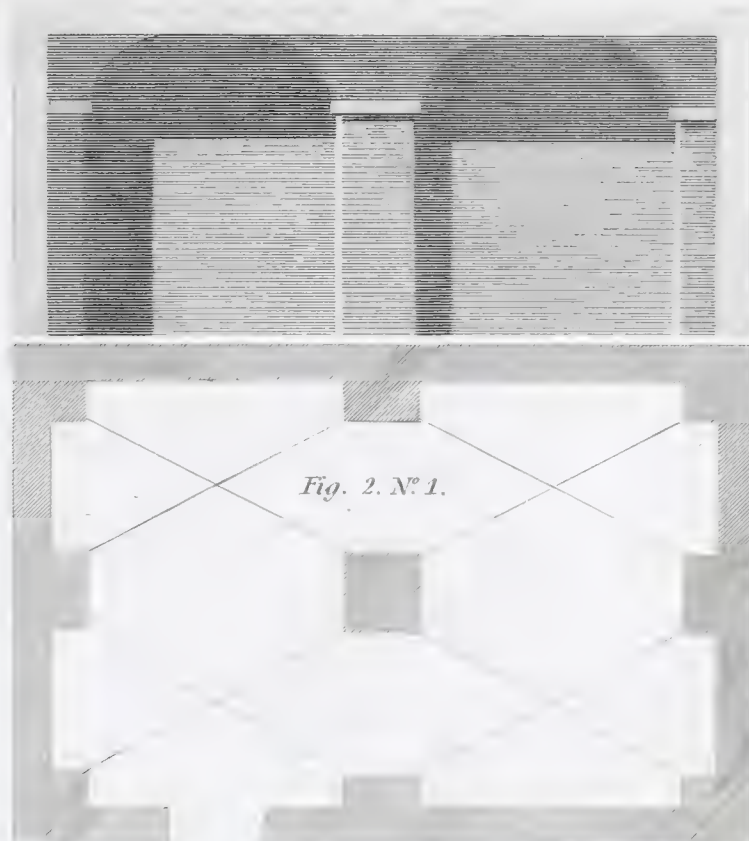


Fig. 2. N° 1.

Fig. 2. N° 3.



Fig. 2. N° 4

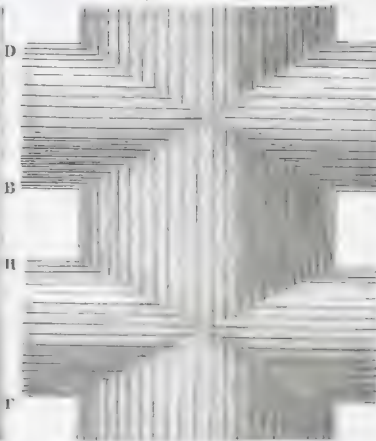


Fig. 2. N° 7.

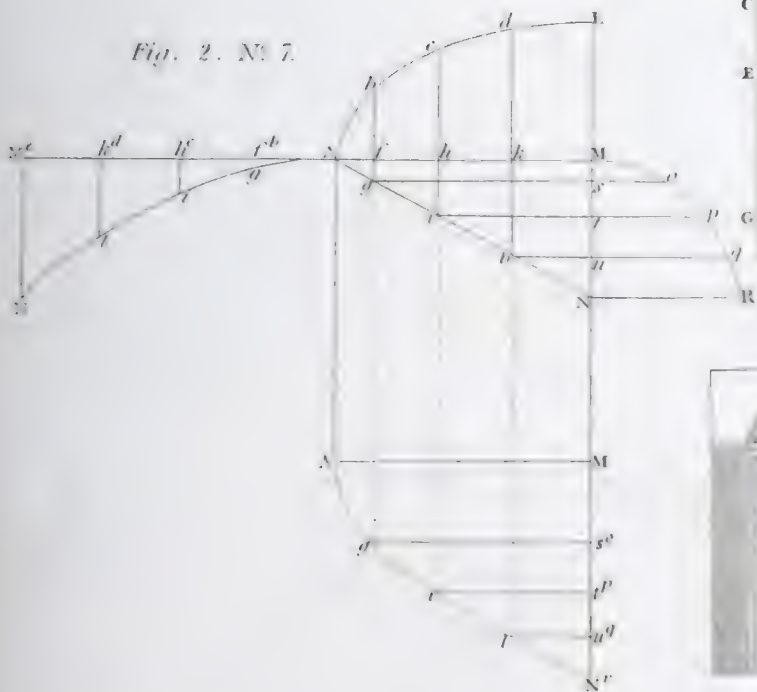


Fig. 2. N° 5



Fig. 2. N° 6



Fig. 1.

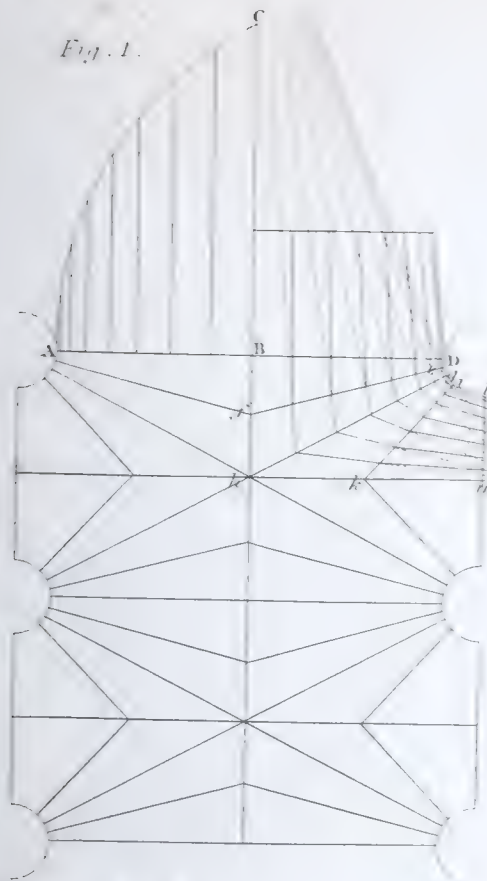


Fig. 2.

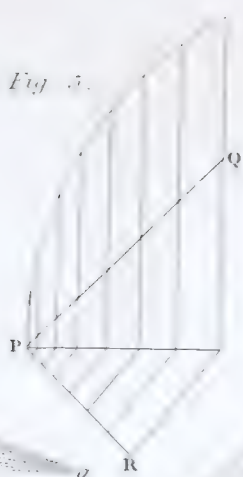


Fig. 3.

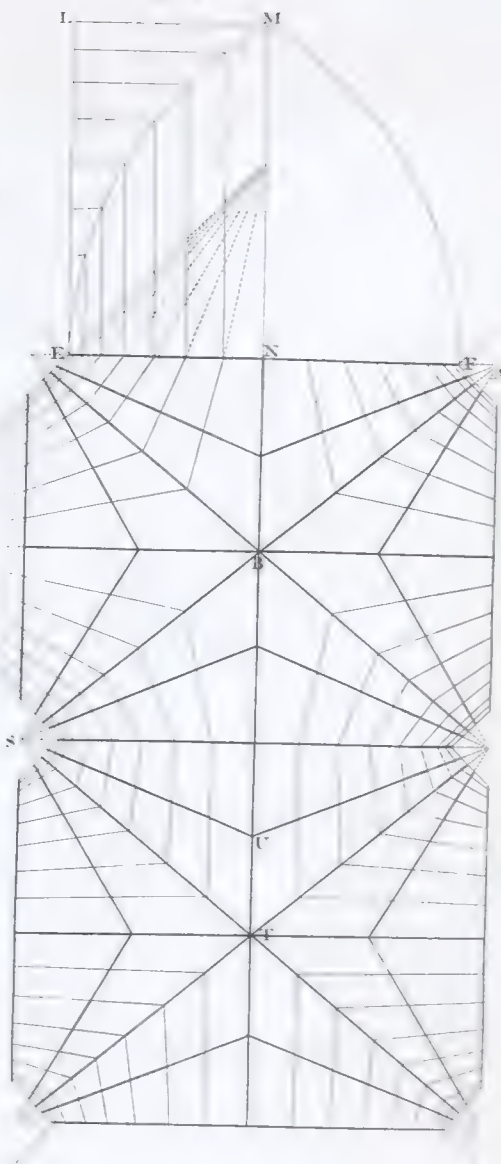


Fig. 4.

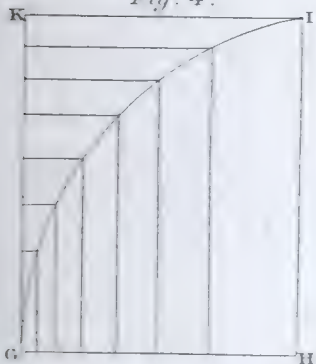


Fig. 5.



Fig. 7.

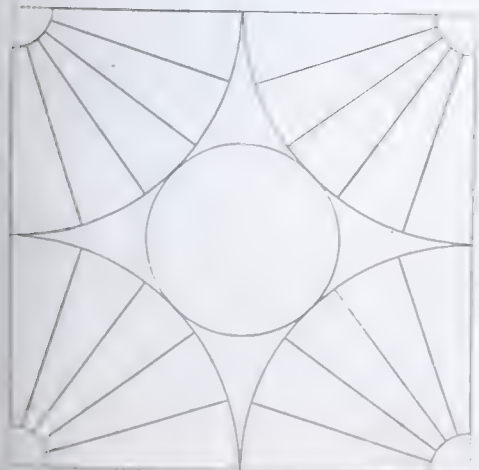


Fig. 6.



Fig. 8.

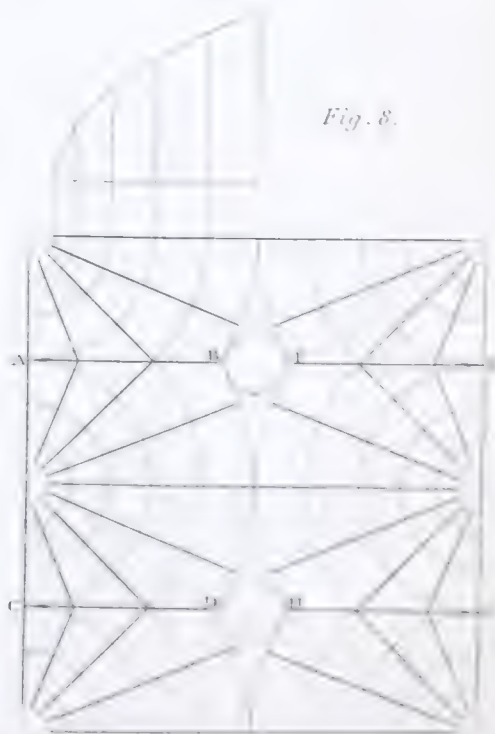






Fig. 2.

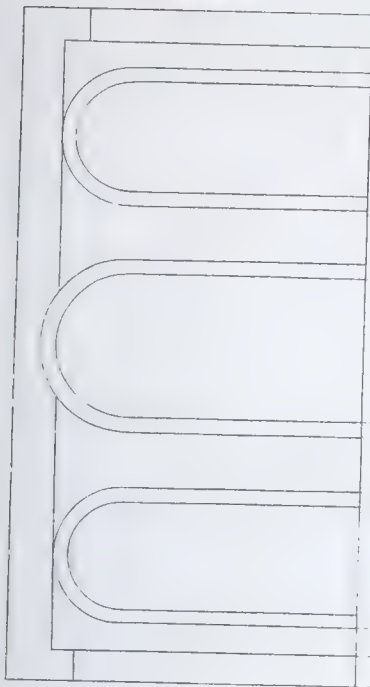


Fig. 1.

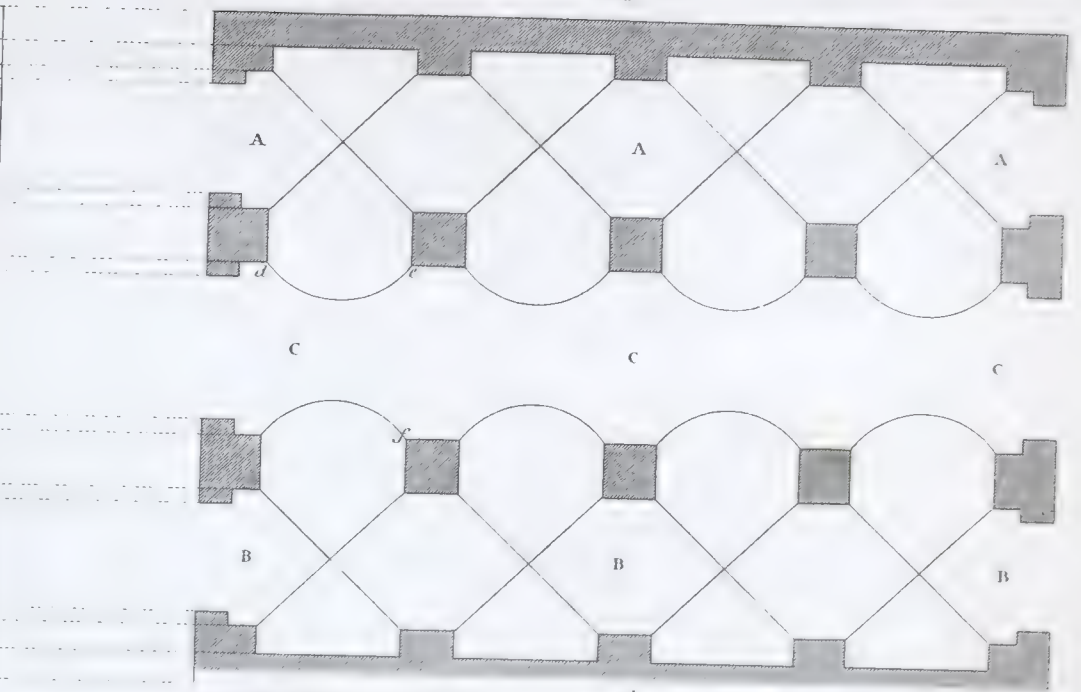
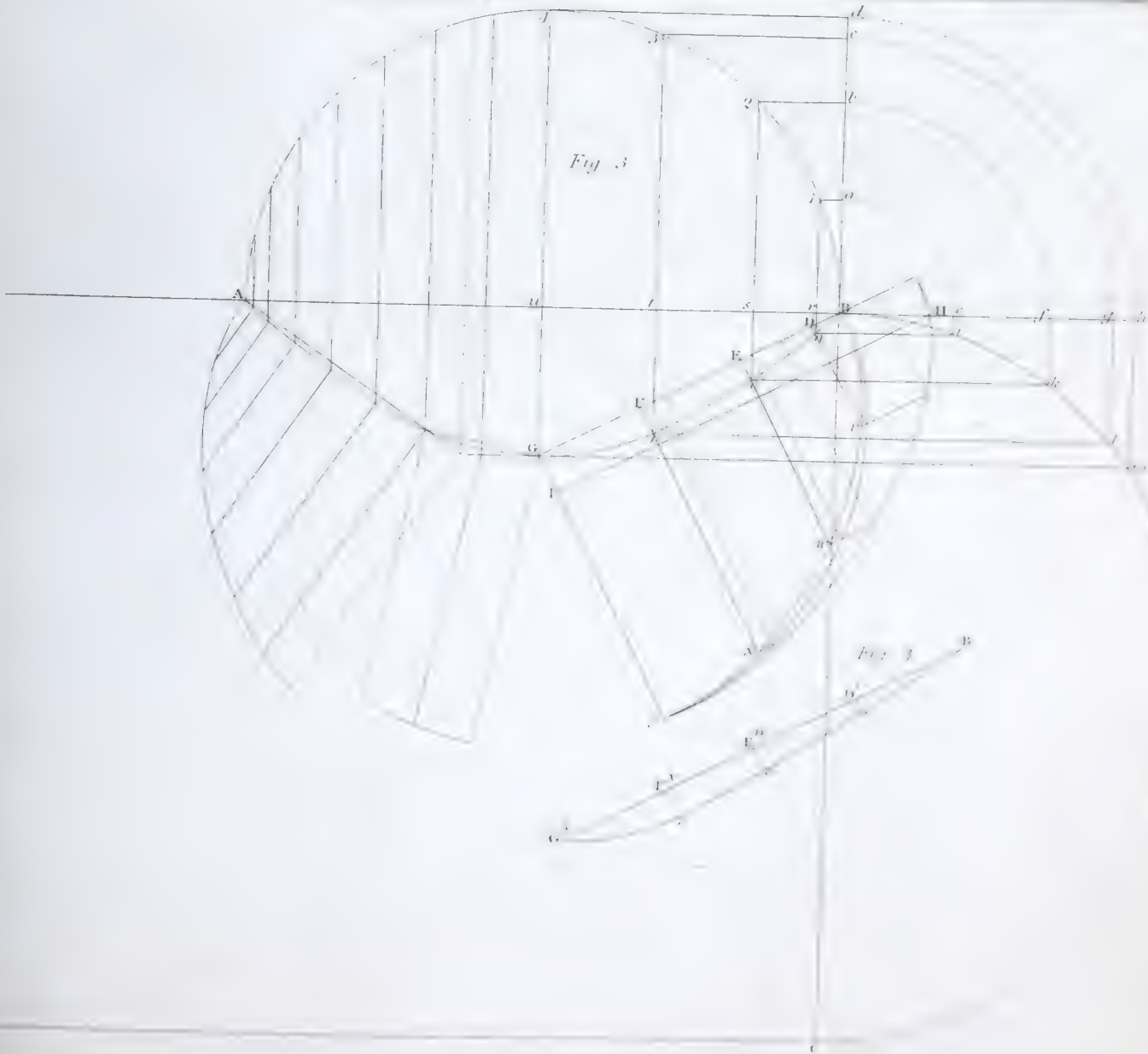


Fig. 3.





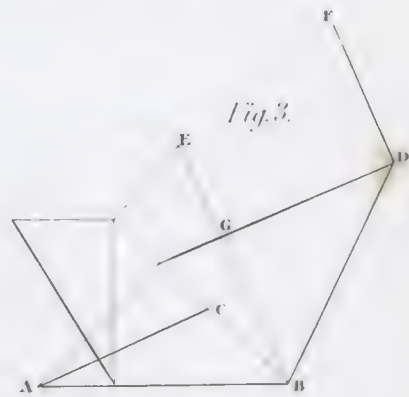
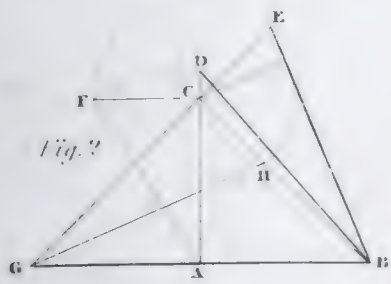
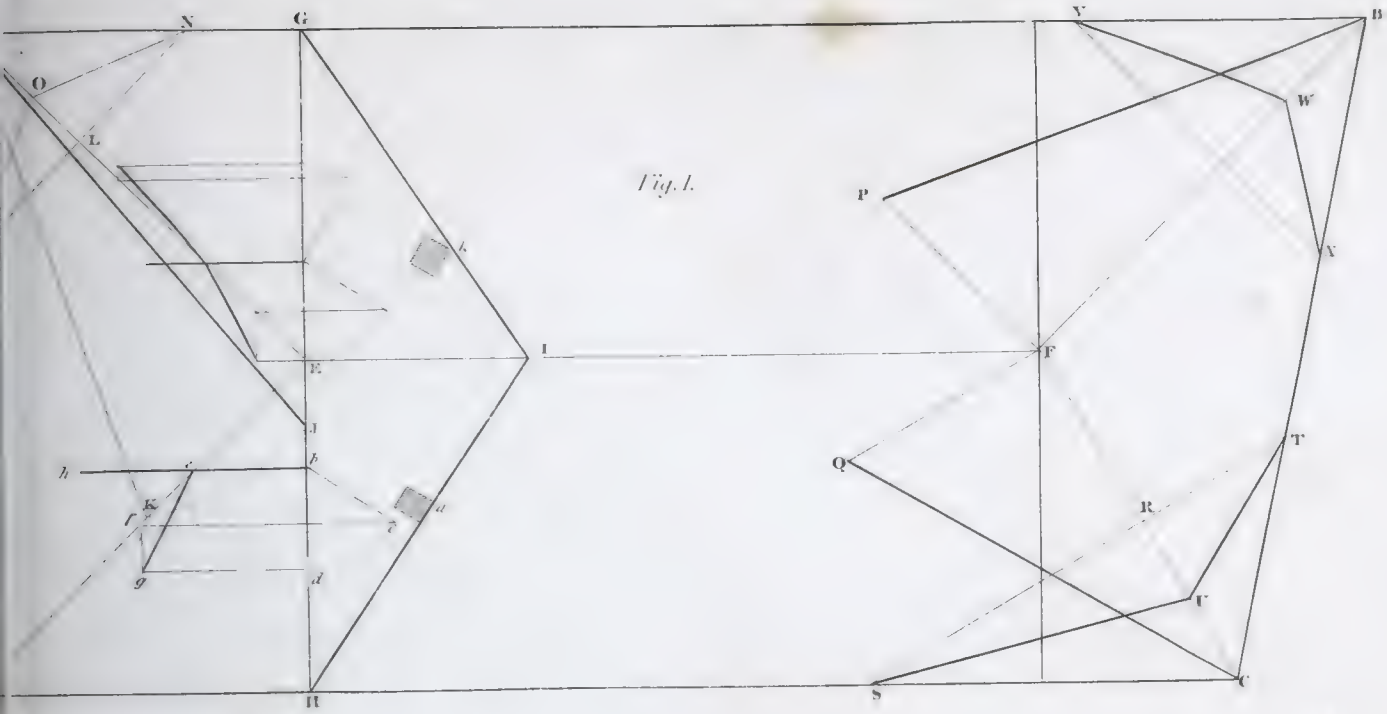




Fig. 1.

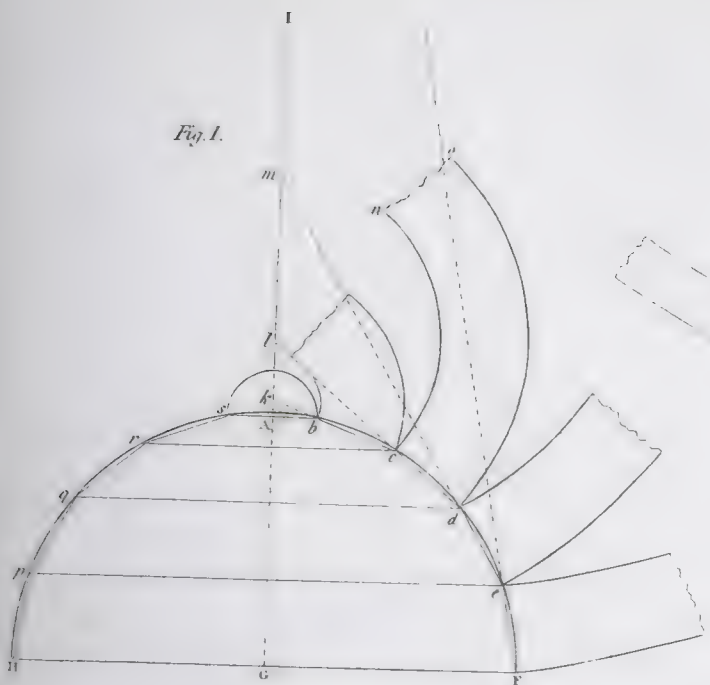


Fig. 2.

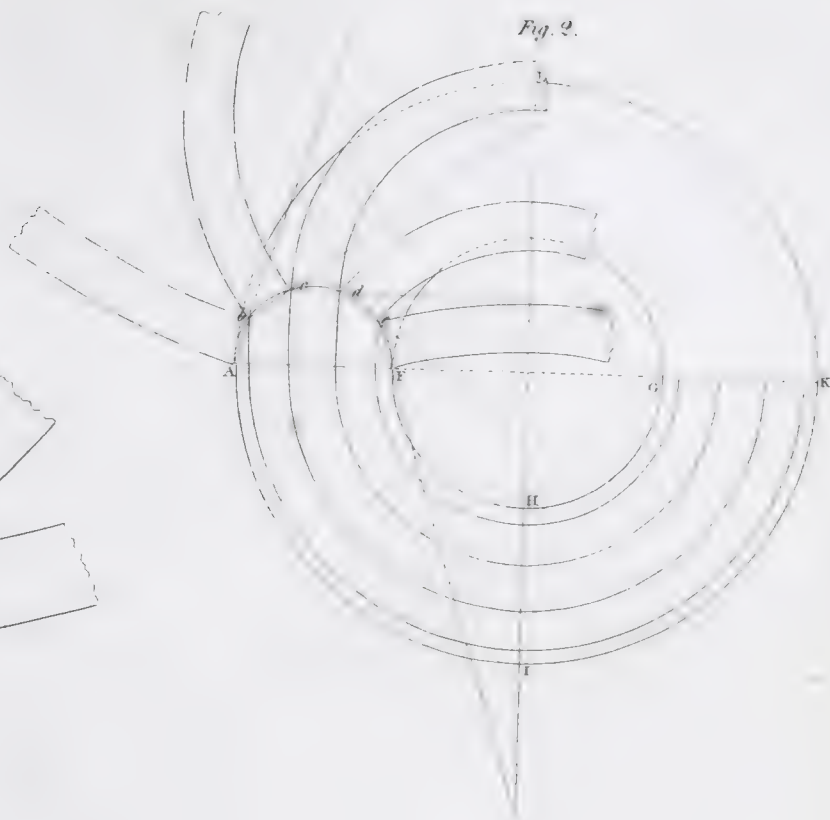


Fig. 3.

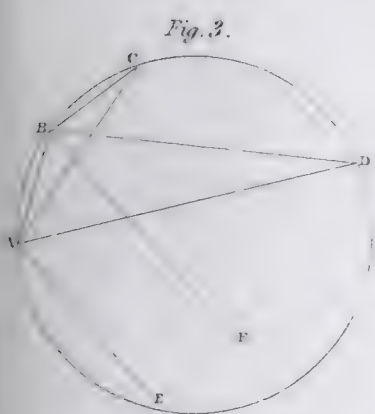


Fig. 5.



Fig. 4.

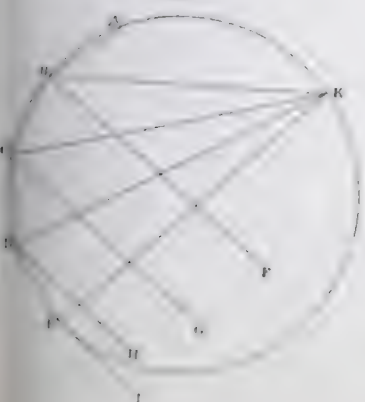


Fig. 6.

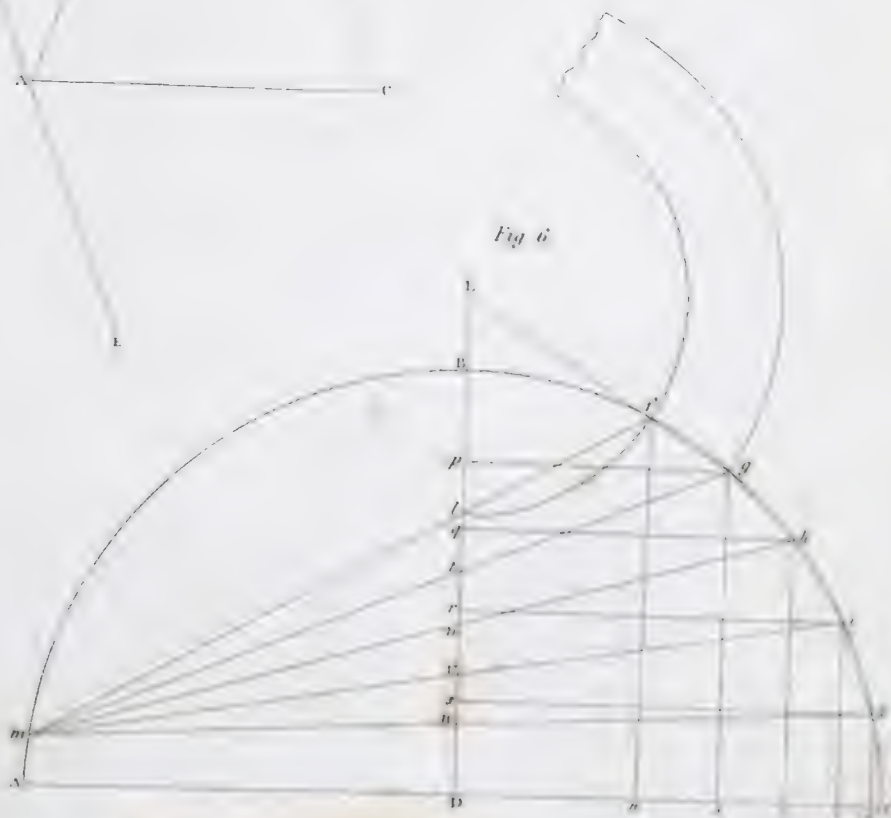




Fig 1.

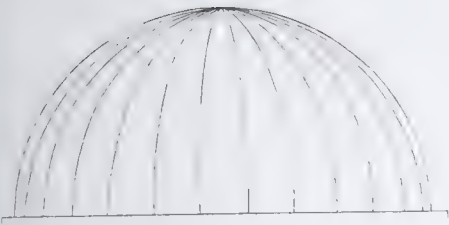


Fig. 2.

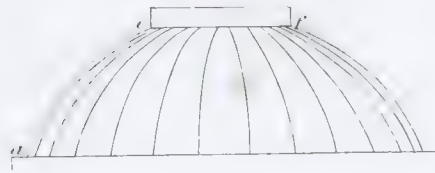


Fig 3.

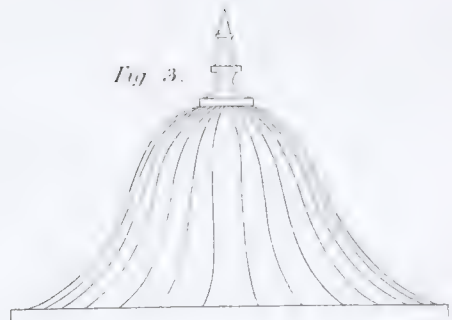


Fig. 4.

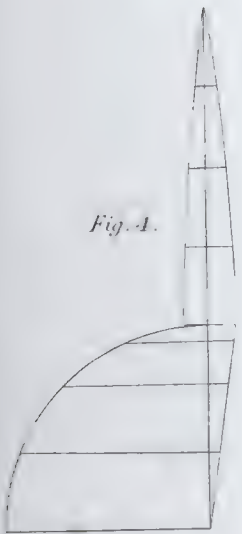


Fig. 5.



Fig. 6.



Fig. 7.



Fig. 8.



Fig. 9 N° 3.



Fig. 9 N° 2.

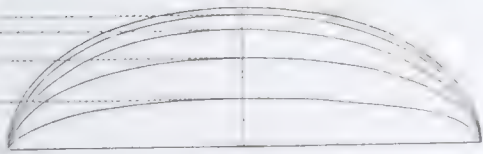


Fig. 10 N° 2.



Fig. 9 N° 4.

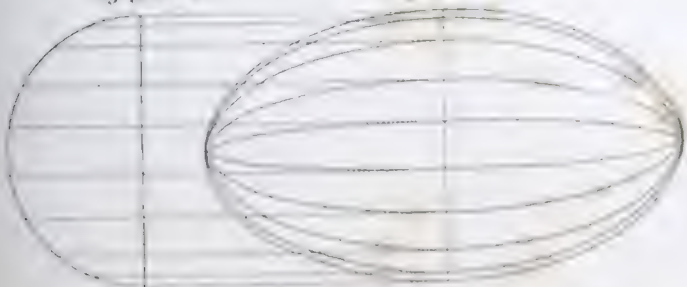


Fig. 9 N° 1.



Fig. 10 N° 1.

Fig 11.











*Fig. 1.*

SCARFINGS.

*Fig. 2.*



*Fig. 3.*

*Fig. 4.*



*Fig. 5.*

*Fig. 6.*



*Fig. 7.*



*Fig. 8.*

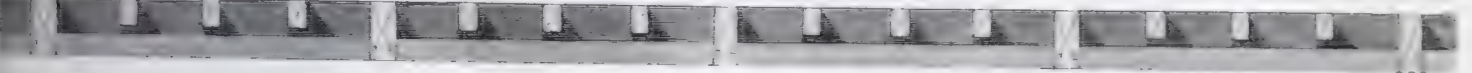


NAKED FLOORING.

*Fig. 9. N° 1.*



*Fig. 9. N° 2.*



*Fig. 10. N° 1.*



*Fig. 10. N° 2.*





# CARPENTRY.

PLATE CXXVII.

Fig. 1.



Fig. 2. N° 1.



Fig. 2. N° 2.



Fig. 2. N° 3. Fig. 2. N° 4.

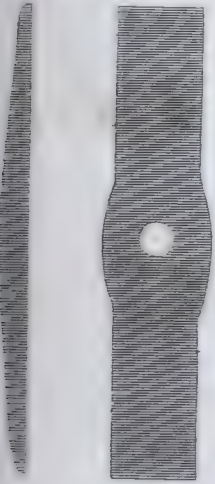


Fig. 2. N° 5.



Fig. 2. N° 6.

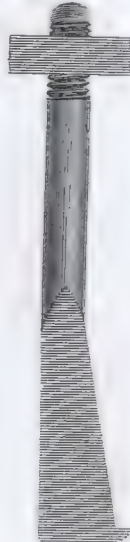


Fig. 2. N° 7.



Fig. 2. N° 8.



Fig. 3.

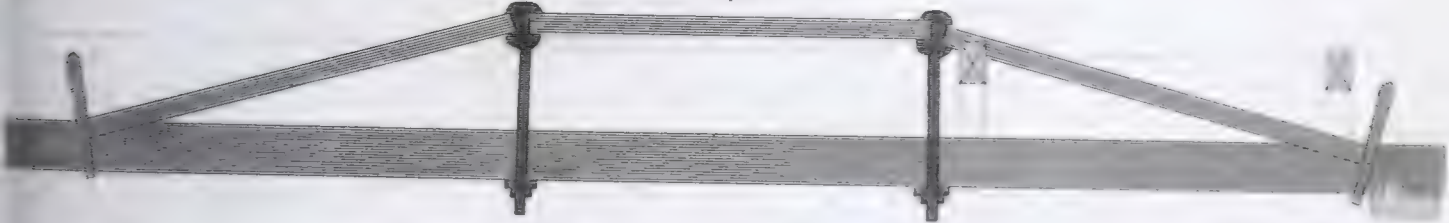


Fig. 5. N° 1.

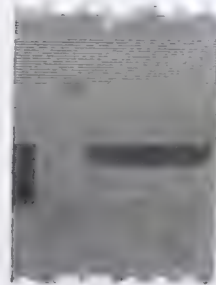


Fig. 4. N° 1.

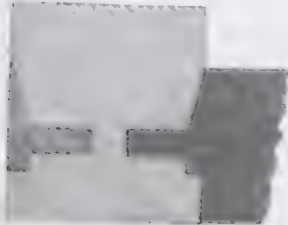


Fig. 5. N° 2.



Fig. 4. N° 2.





# CARPENTRY.

# PLATE CXXVIII.

Fig. 1.

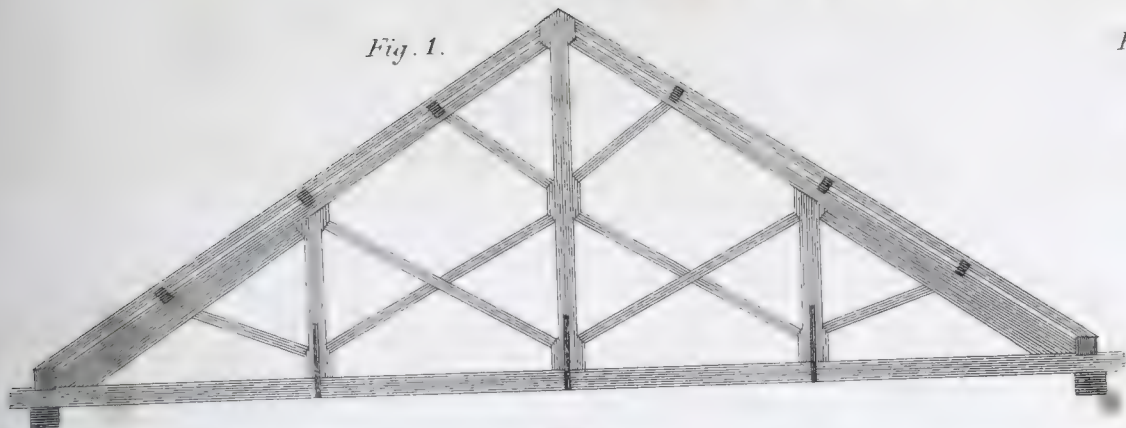


Fig. 2.

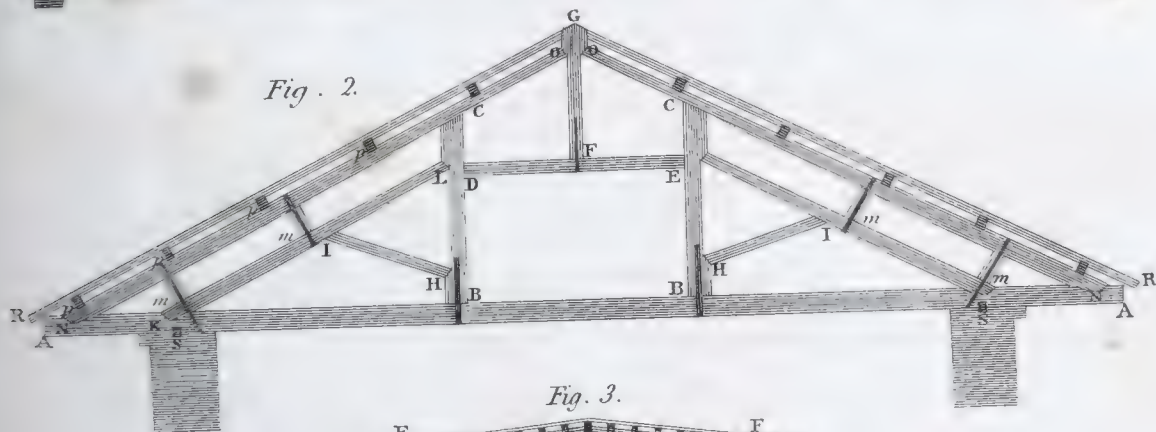


Fig. 3.

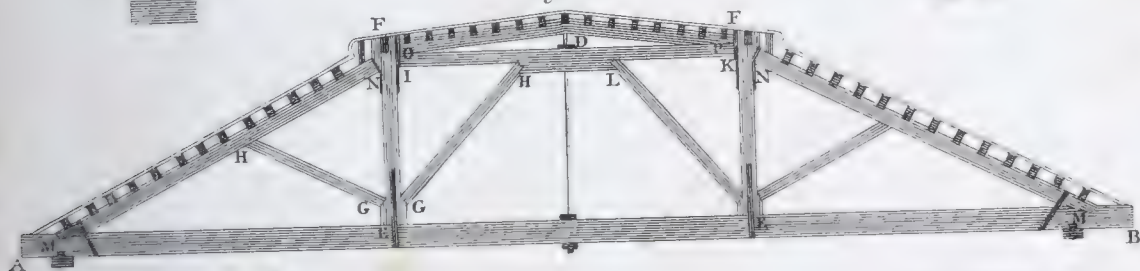


Fig. 4. N°1.

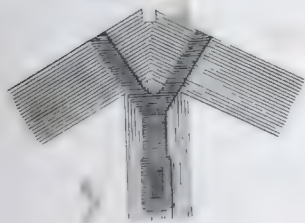


Fig. 5. N°1.

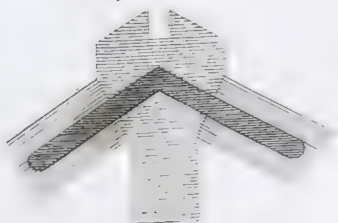


Fig. 4. N°3.

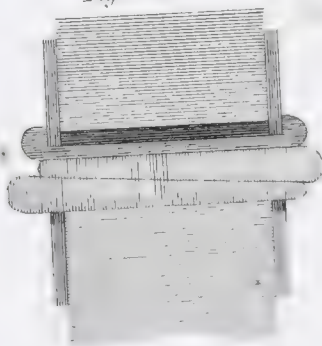


Fig. 3. N°1.

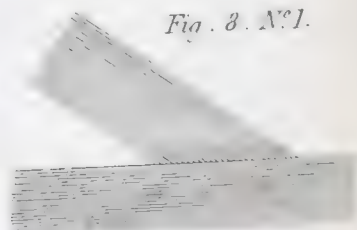


Fig. 4. N°2.



Fig. 5. N°2.



Fig. 10. N°1.

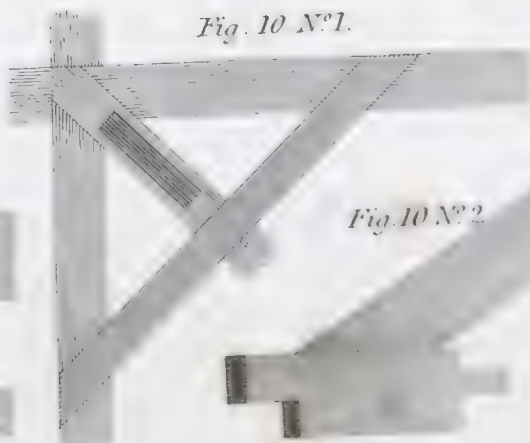


Fig. 3. N°2.

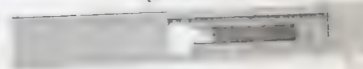


Fig. 9.



Fig. 10. N°3.

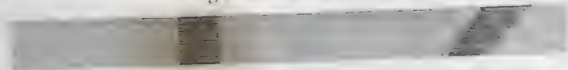






Fig. 10.



Fig. 11.



Fig. 12.



Fig. 7.

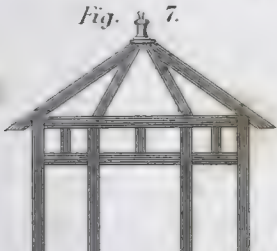


Fig. 1.

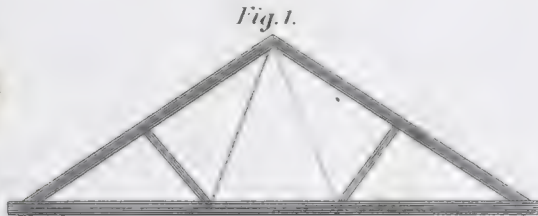


Fig. 9.

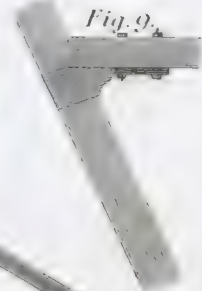


Fig. 2.

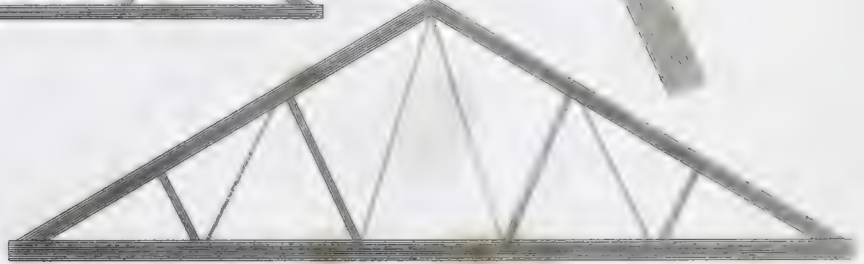


Fig. 3.

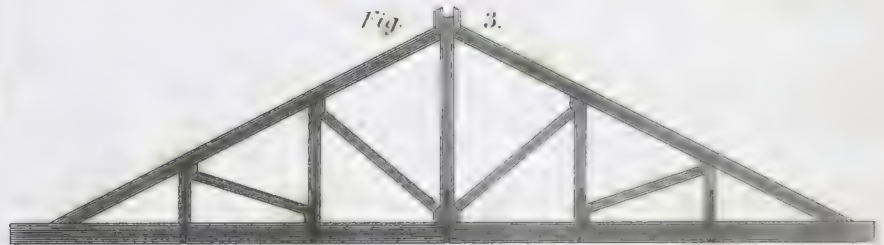


Fig. 4.

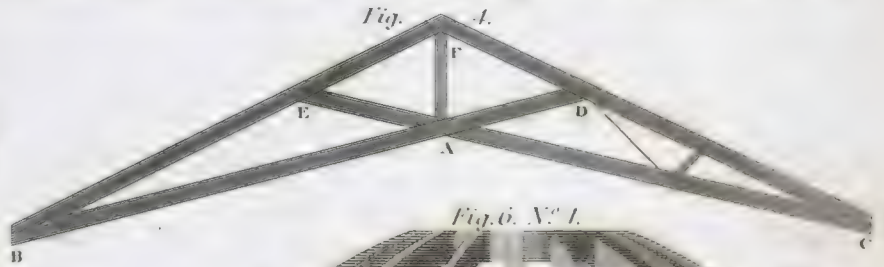


Fig. 8.



Fig. 5. N° 1.

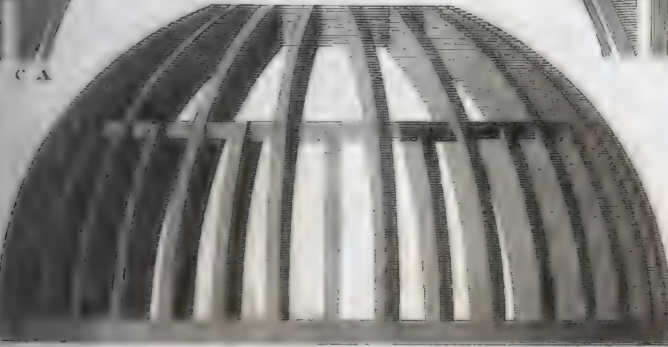


Fig. 6. N° 1.



Fig. 5. N° 2.

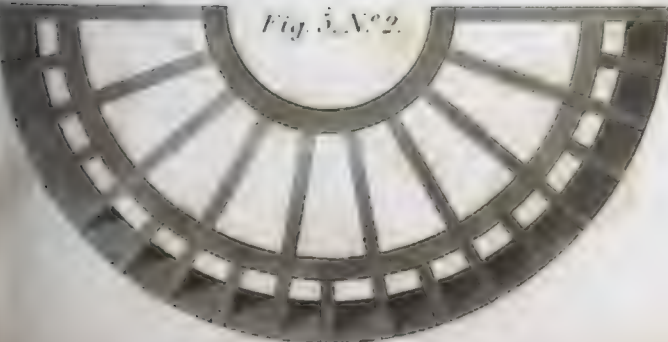


Fig. 6. N° 2.





DRAW LOOM OR HARNESS WORK.

Fig. 1.

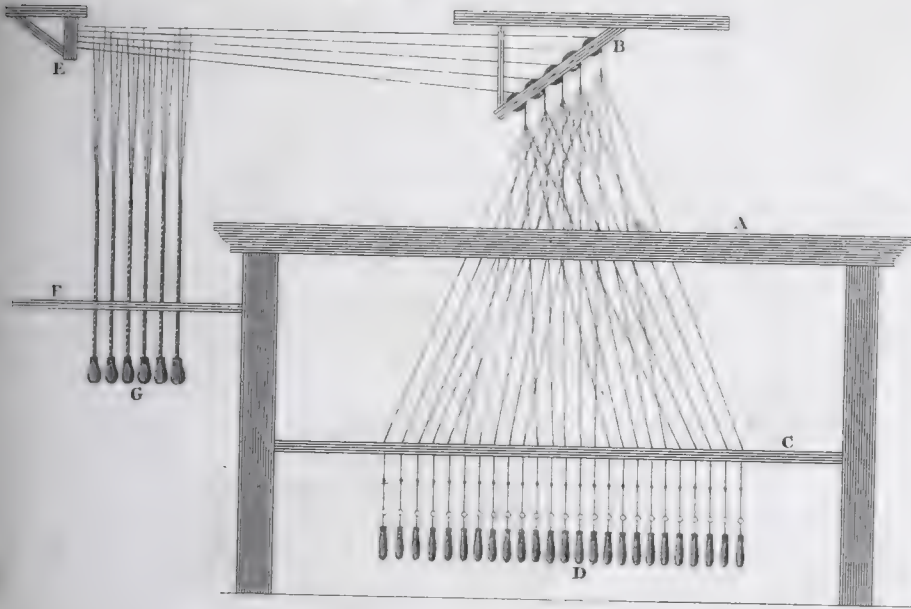


Fig. 2.

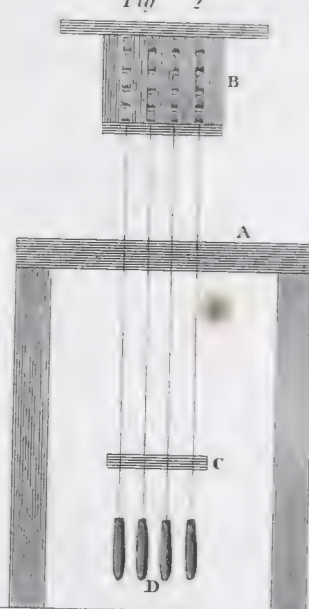
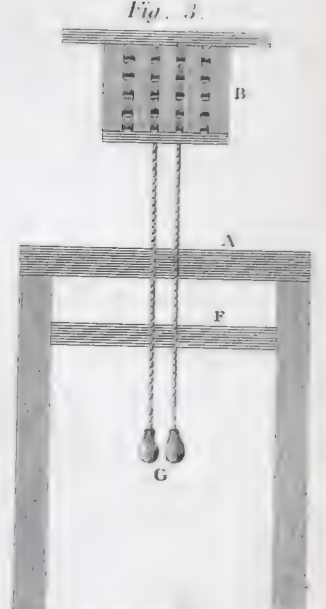


Fig. 3.



COMMON DAMASK LOOM.

Fig. 4.

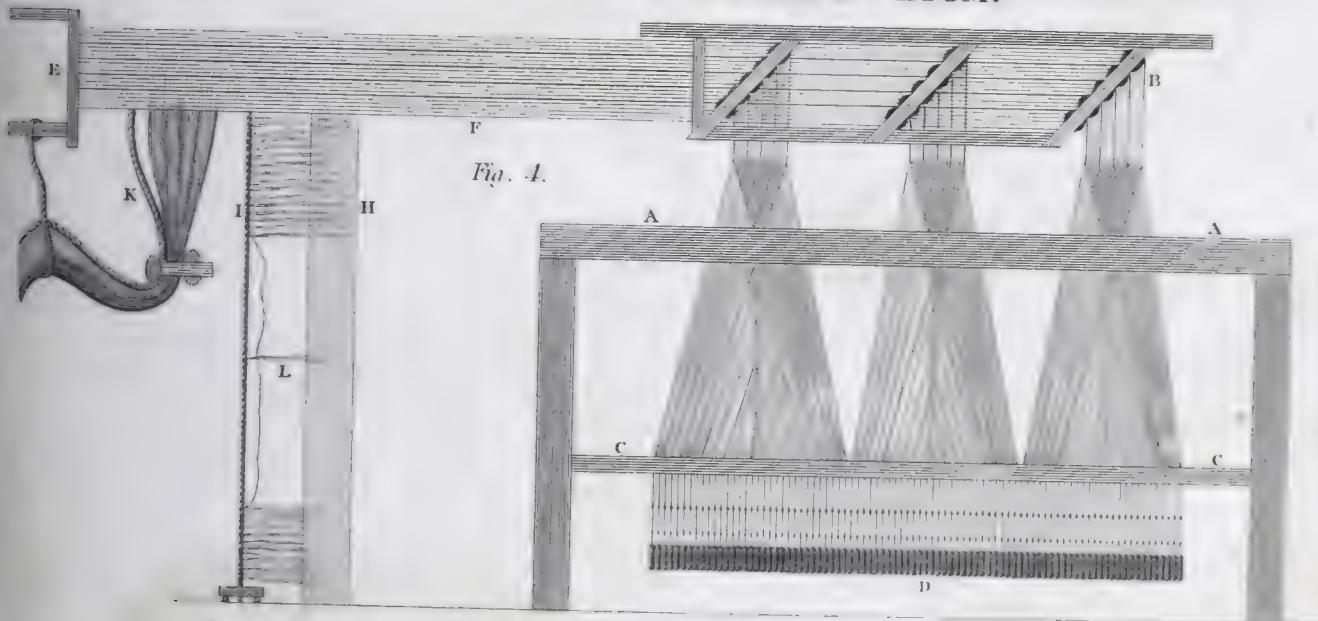


Fig. 5.

FRONT LEAVES.



AUTOMATIC CARPET DRAW LOOM.

Invented by John Duncan

Fig. 6.

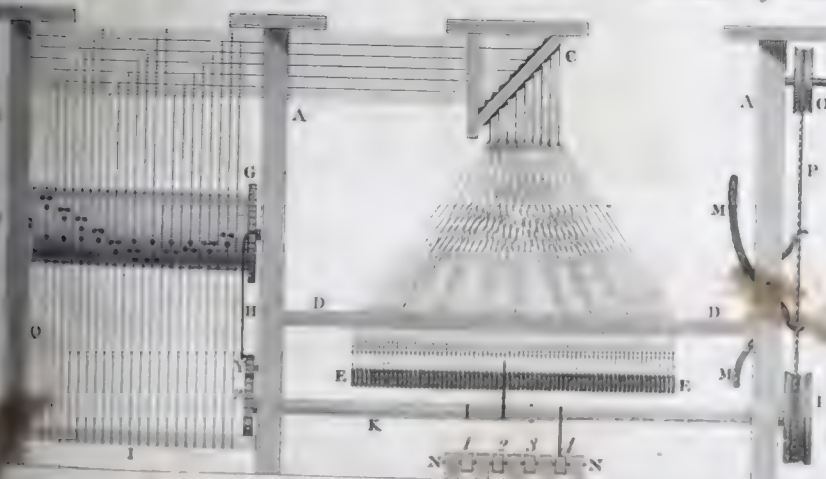


Fig. 7.

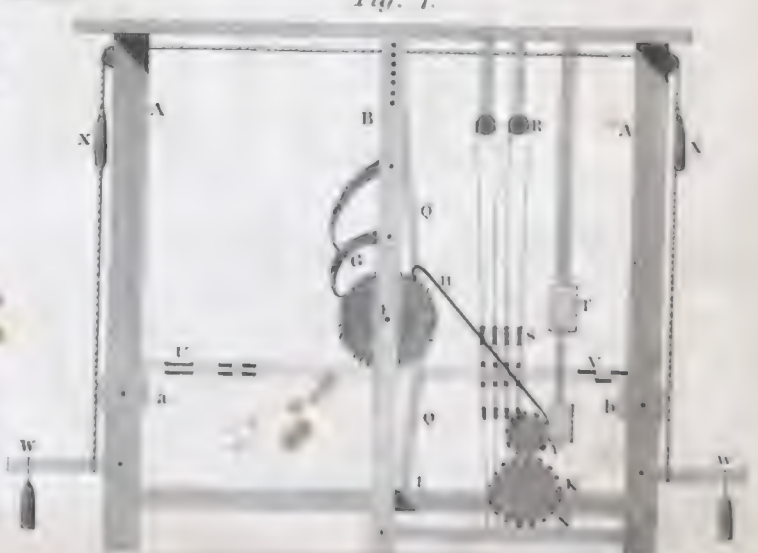
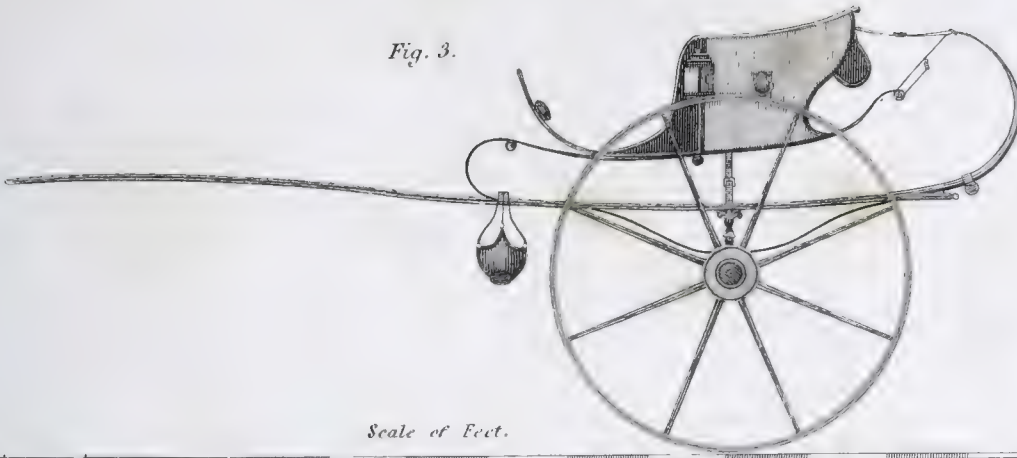








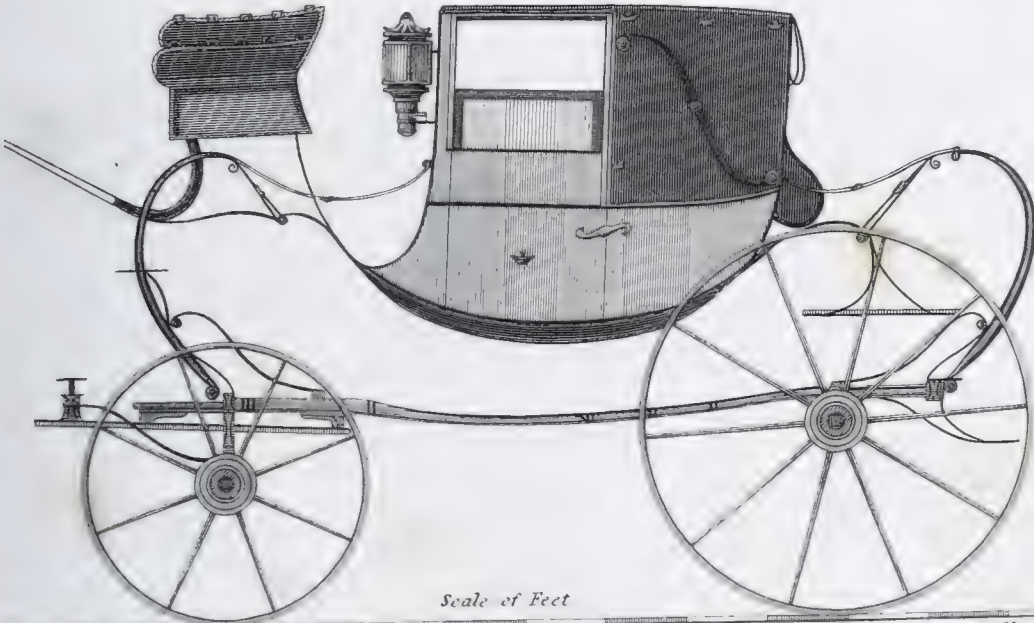
Fig. 3.



Scale of Feet.



Fig. 2.



Scale of Feet

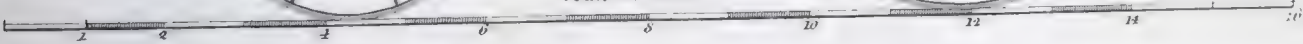
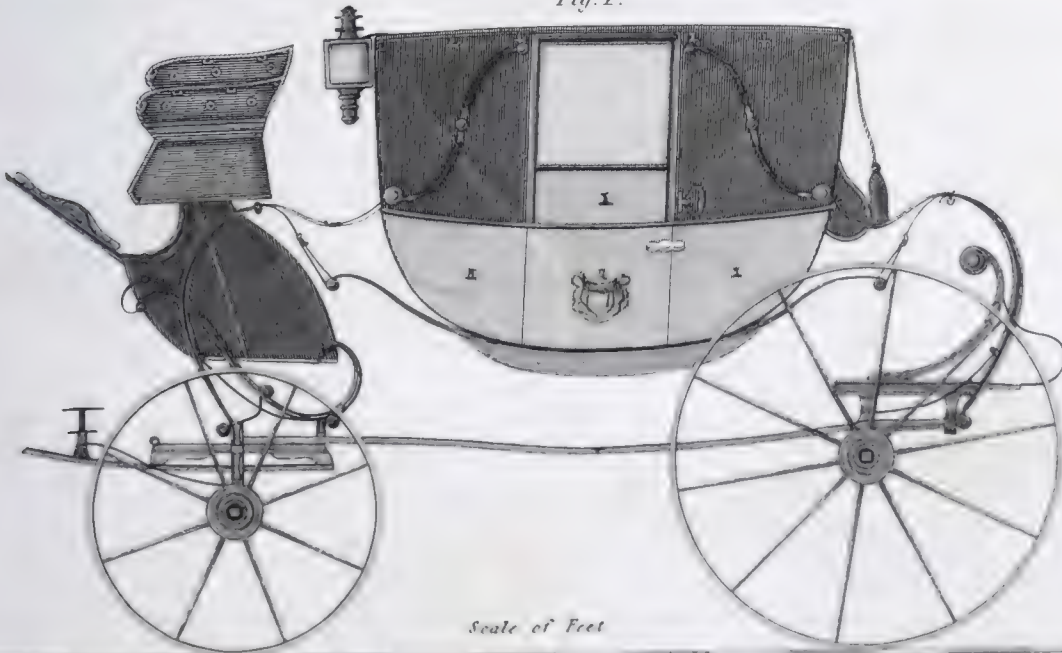


Fig. 1.



Scale of Feet







Fig. 1.



Fig. 2.



Fig. 3.



Fig. 5.

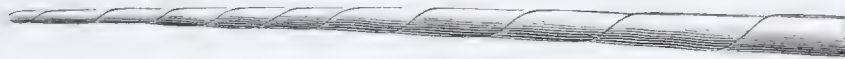


Fig. 6.

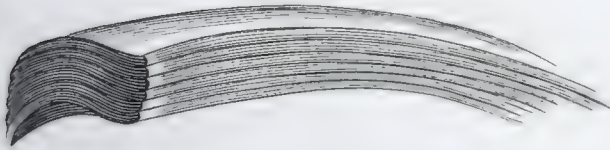


Fig. 4.

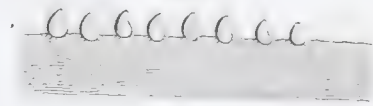


Fig. 8.

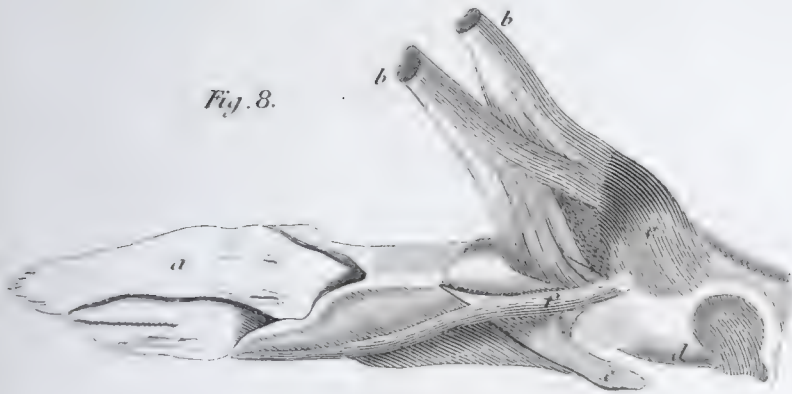


Fig. 7.

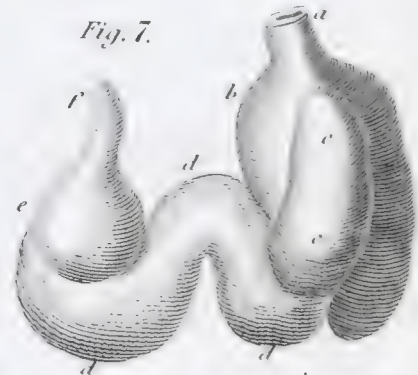


Fig. 9.



Fig. 10.





# CETOLOGY.

PLATE CXXXIV.

GREENLAND WHALE from a drawing taken by M<sup>r</sup> SCORESBY JUN<sup>r</sup> being the only Correct Representation of this ANIMAL.



Fig. 1.

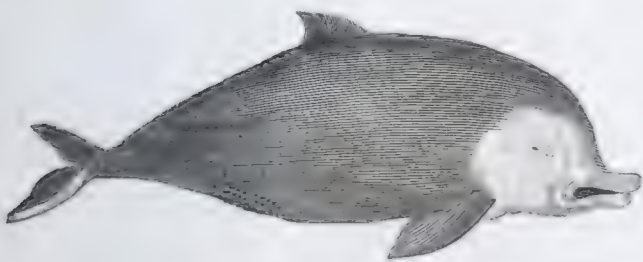
SMALL HEADED NARWHAL.



Fig. 3.

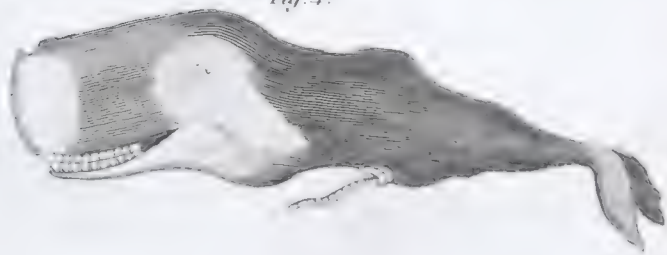
BEAKED WHALE.

Fig. 5.



SPERMACETI WHALE.

Fig. 4.



PIKED WHALE.

Fig. 2.





# CHAFF CUTTER.

Fig. 1.

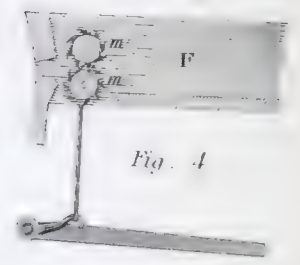
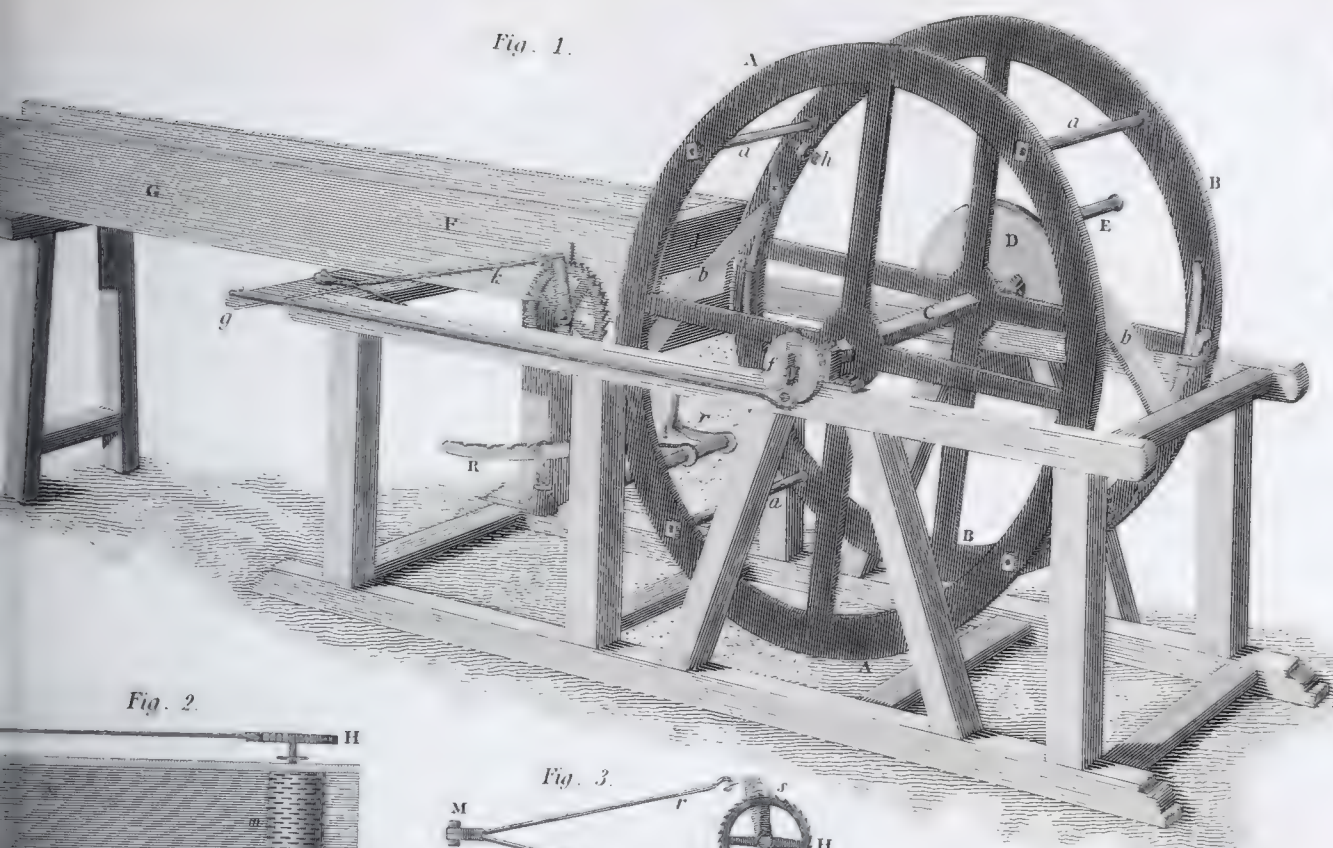


Fig. 4

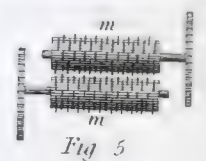


Fig. 5

Fig. 2.

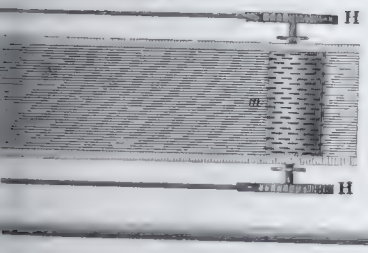


Fig. 3.

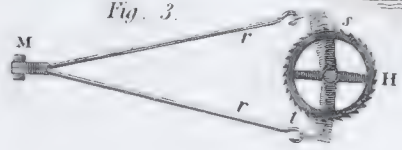


Fig. 3.

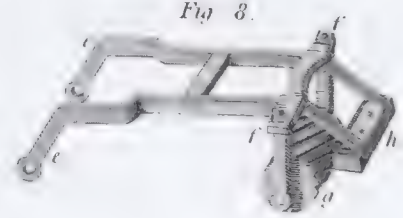


Fig. 6.

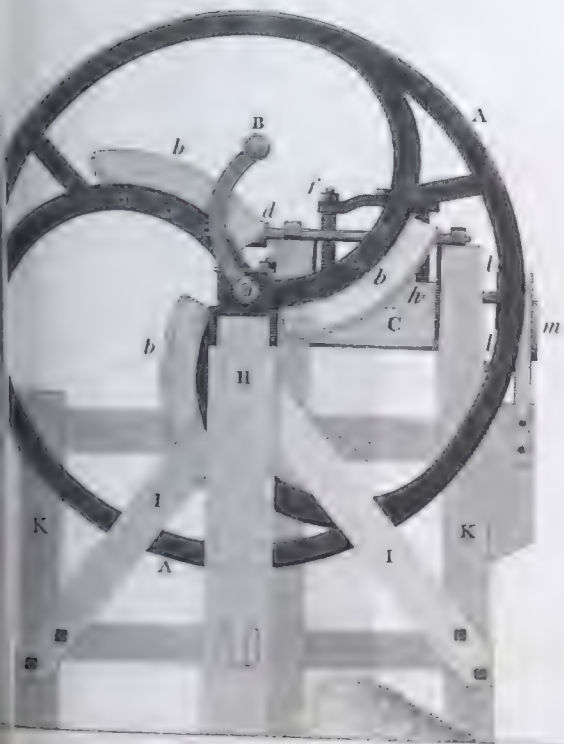
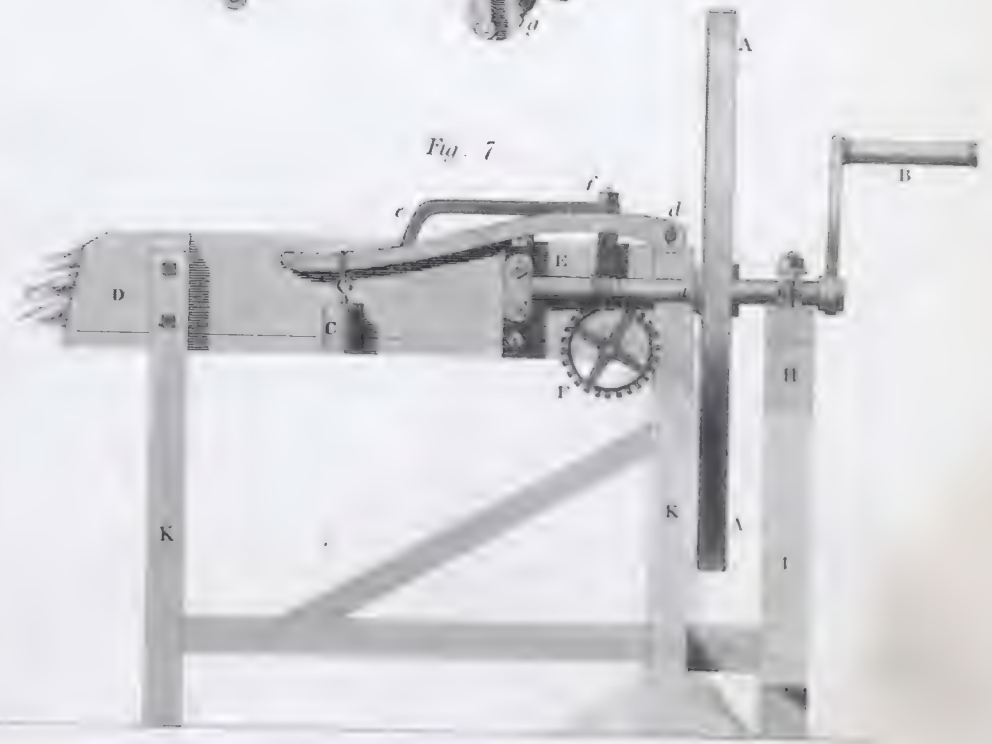


Fig. 7.





TAMBOURING-MACHINE.

Fig. 1.

Fig. 2.

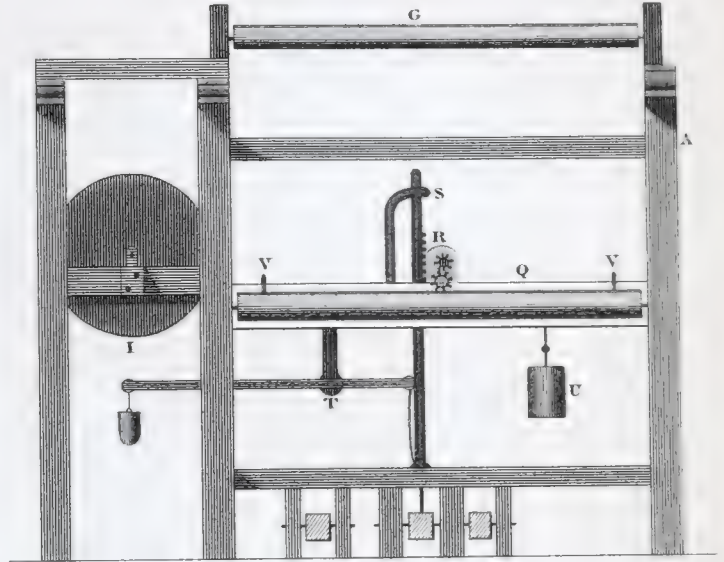
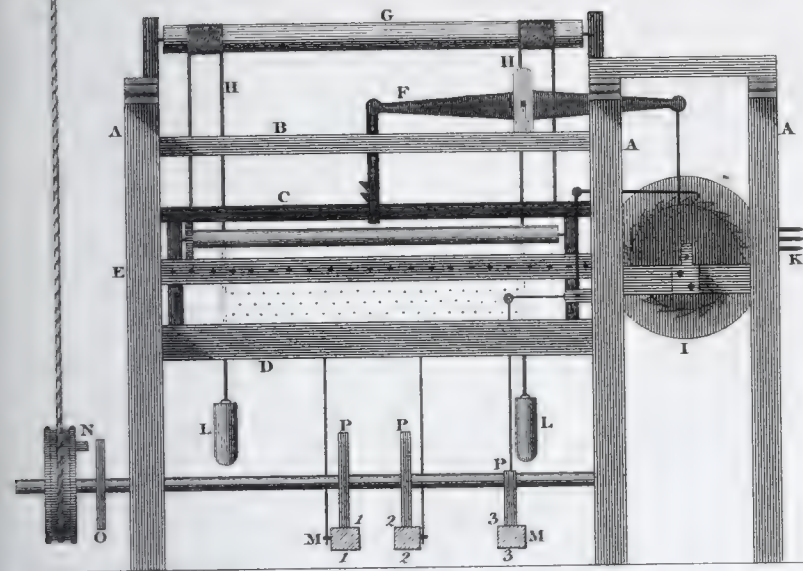


Fig. 4.

Fig. 6.

Fig. 3.

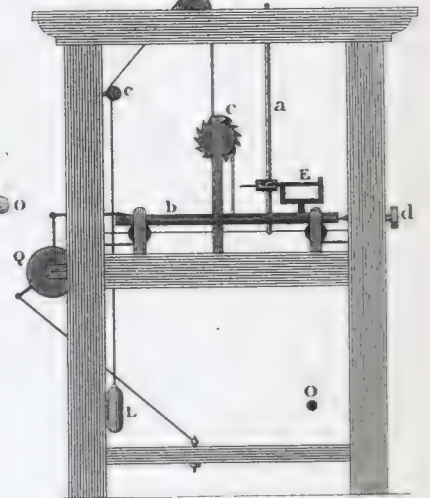
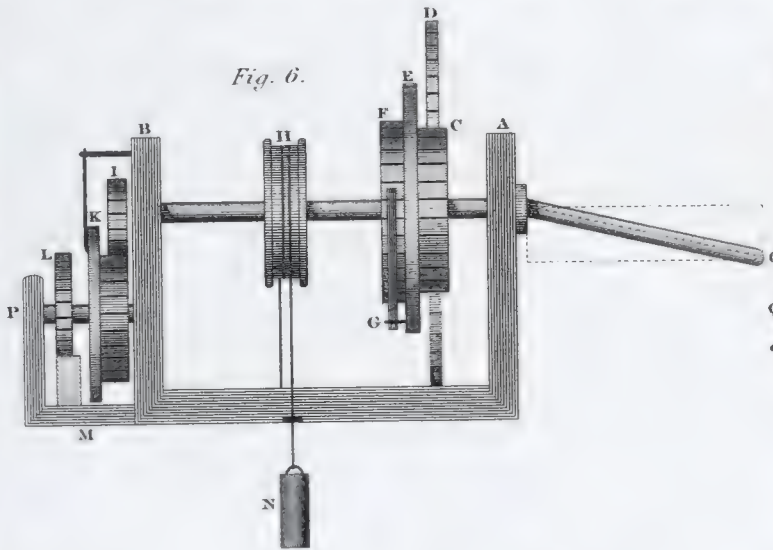
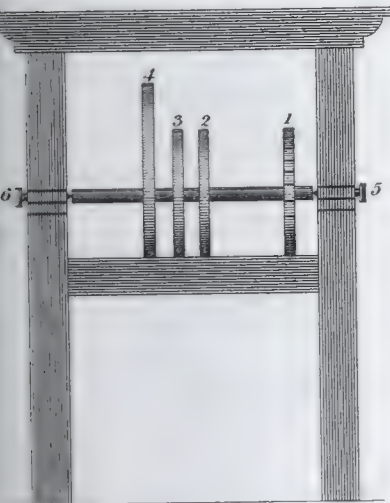
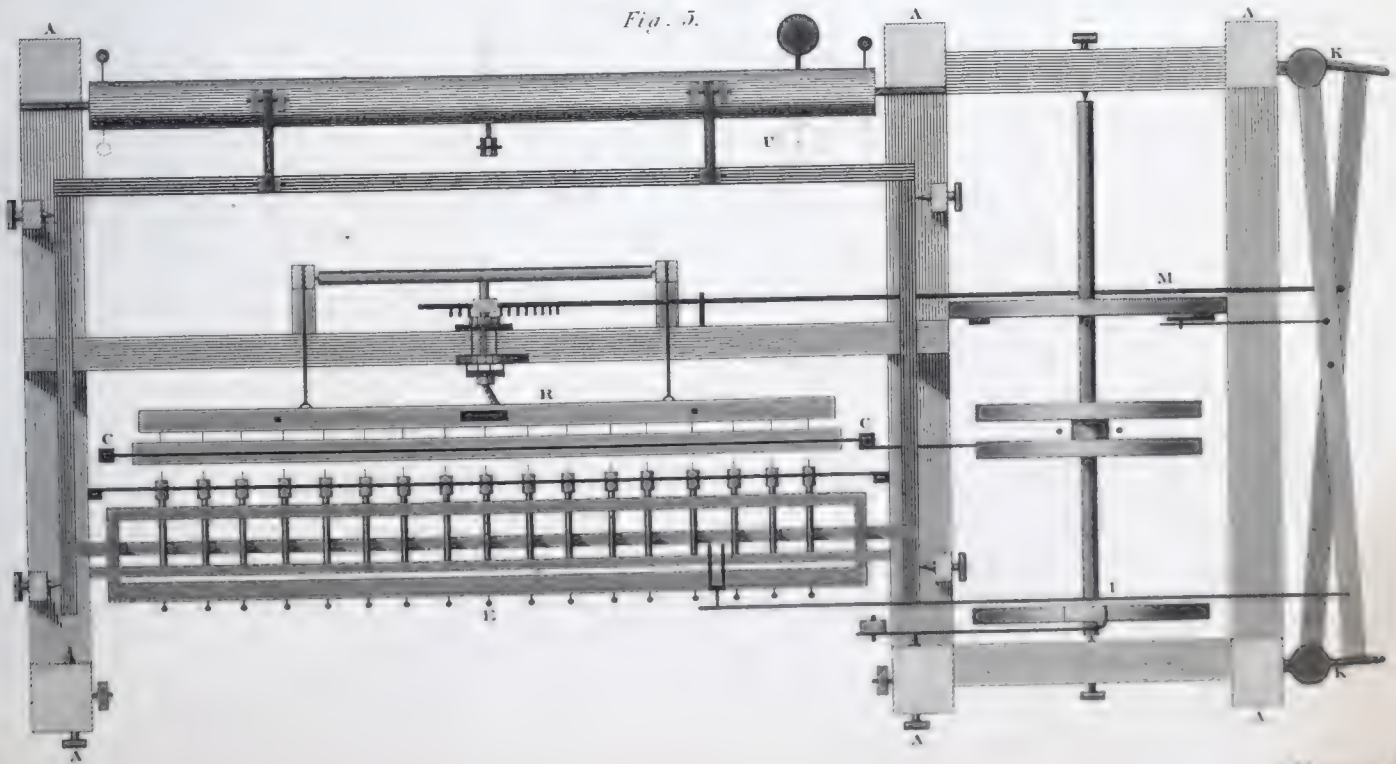
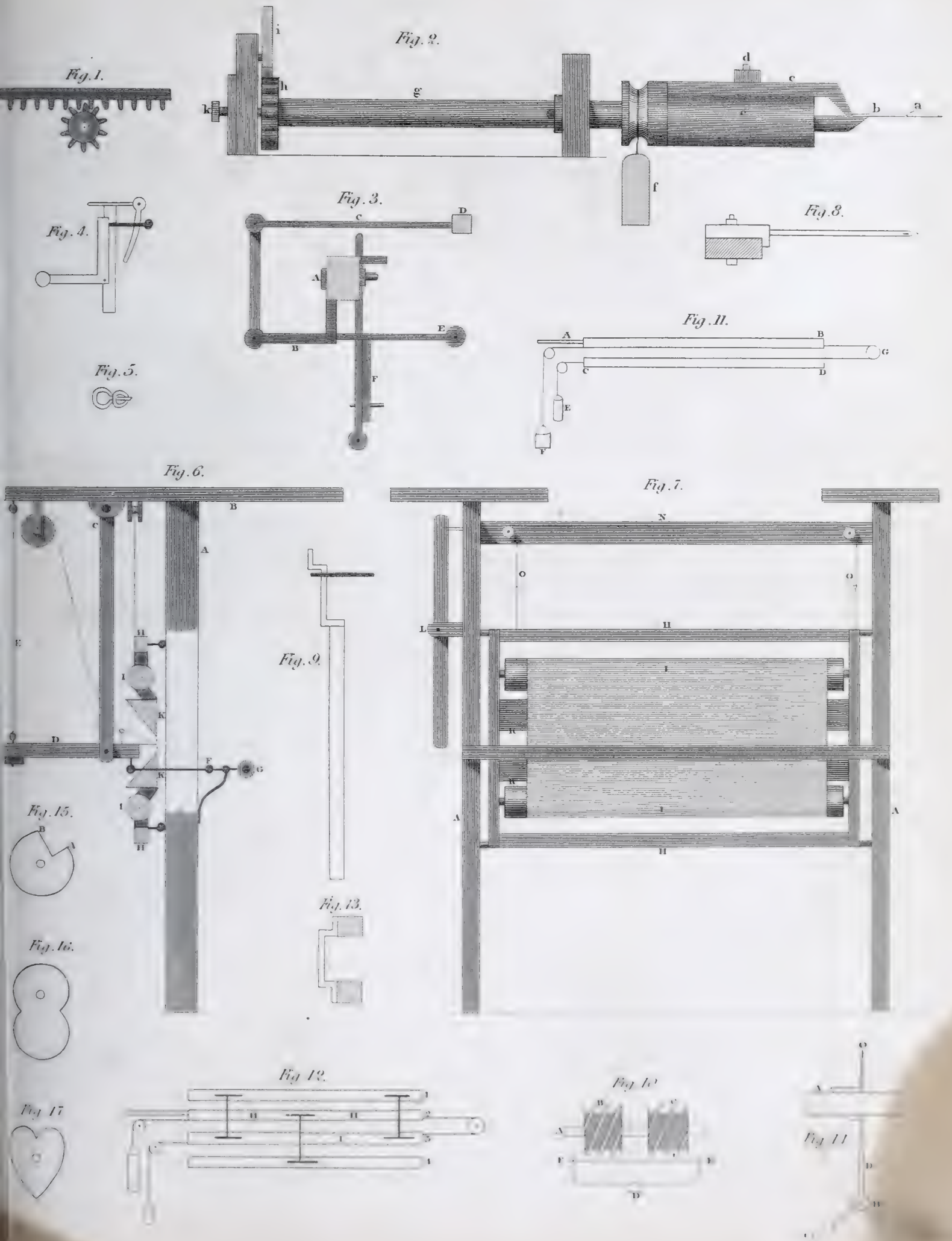


Fig. 5.







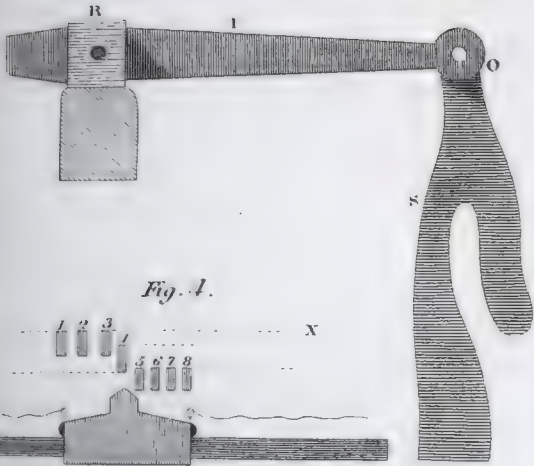




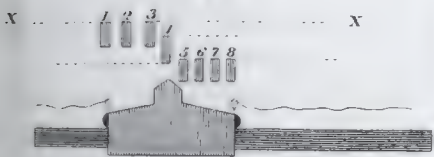
# CHAINWORK. STOCKING MANUFACTURE.

*PLATE CXXXVIII.*

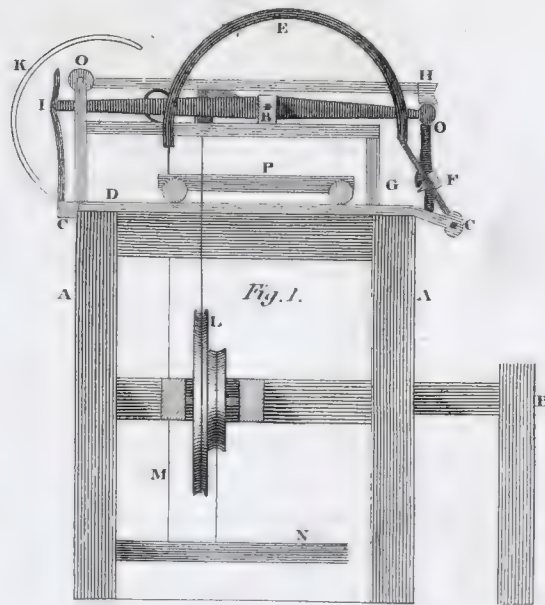
*Fig. 3.*



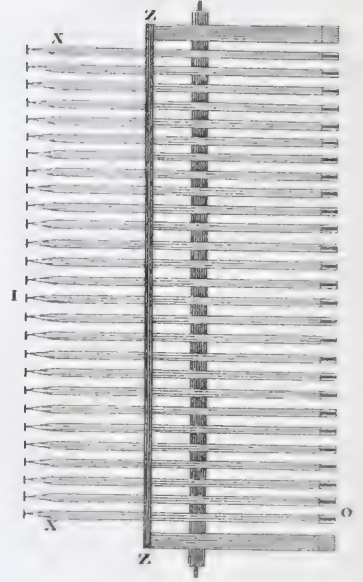
*Fig. 4.*



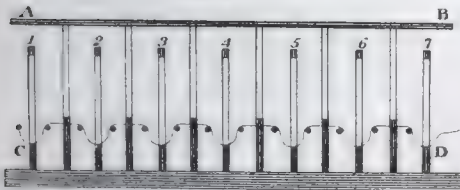
*COMMON FRAME.*



*Fig. 2.*

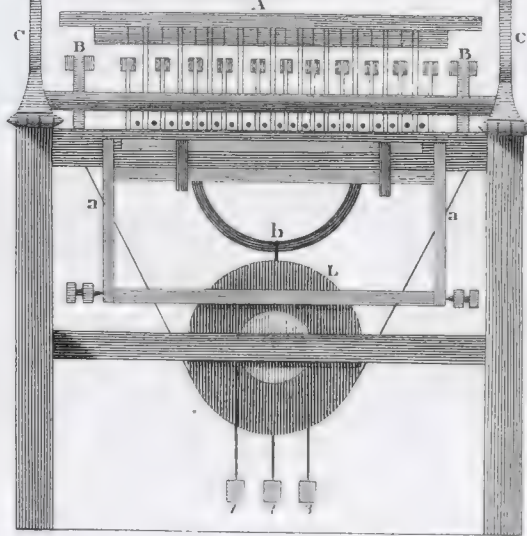


*Fig. 6.*



*RIB STOCKING FRAME.*

*Fig. 5.*



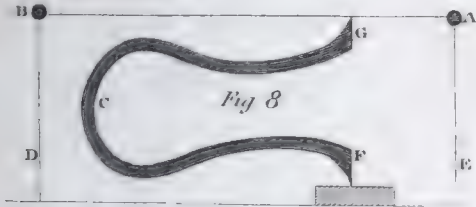
*Fig. 9.*



*Fig. 7.*

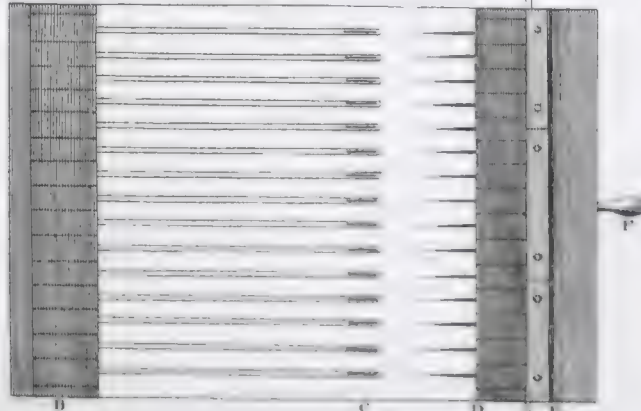


*Fig. 8.*



*PLATED STOCKING FRAME.*

*Fig. 10.*



*Fig. 12.*



*Fig. 13.*



*Fig. 14.*



*Fig. 11.*

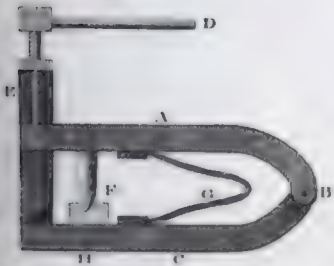




Fig. 1.

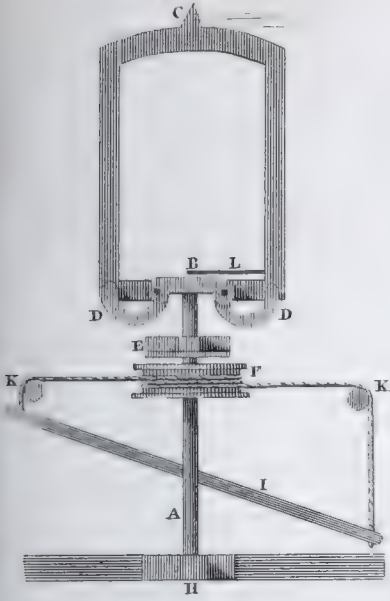


Fig. 2.

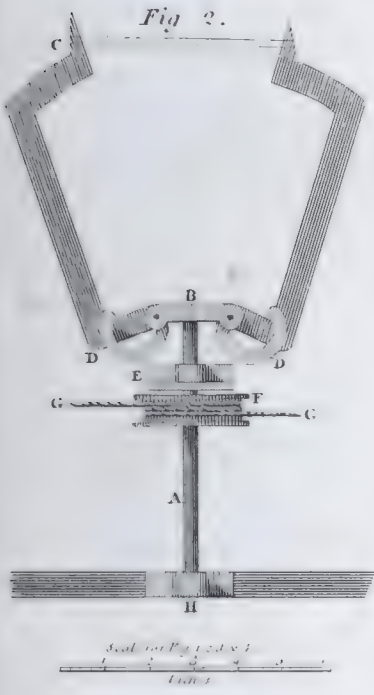


Fig. 5.

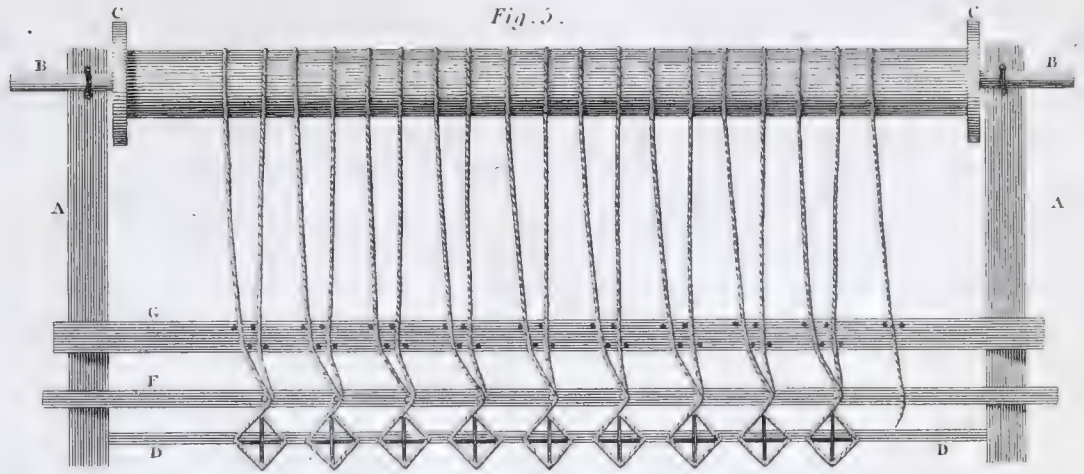


Fig. 6.

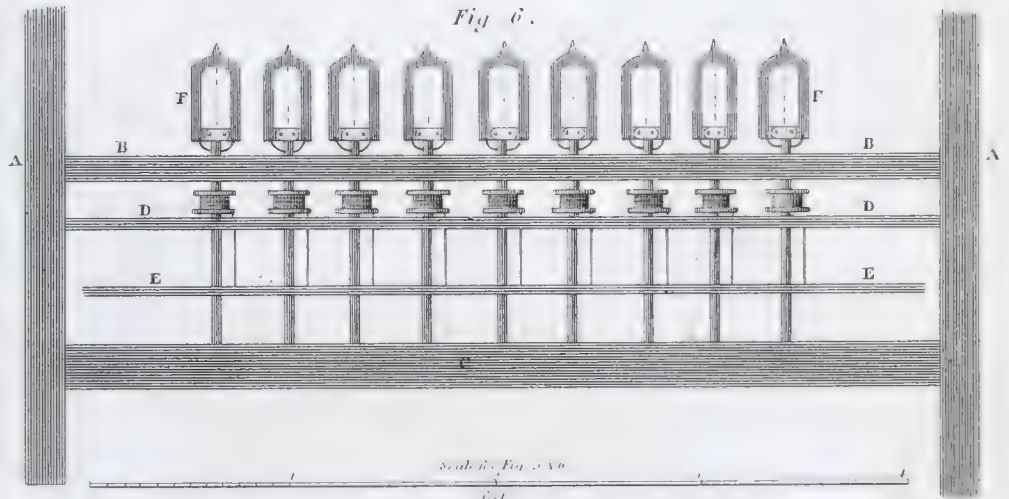


Fig. 8.

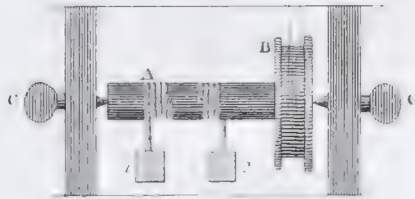


Fig. 9.

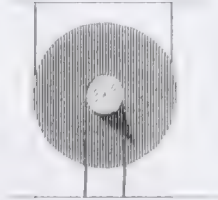


Fig. 3.

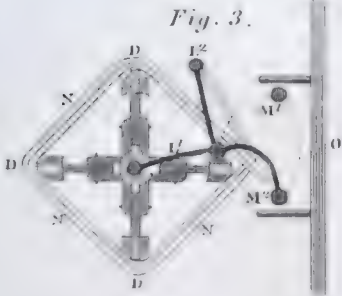


Fig. 4.

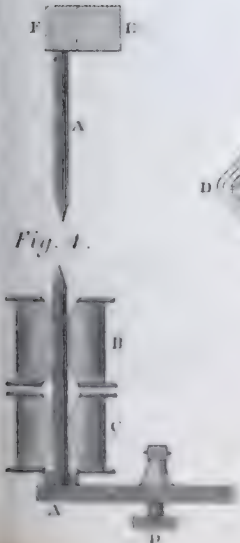


Fig. 7.

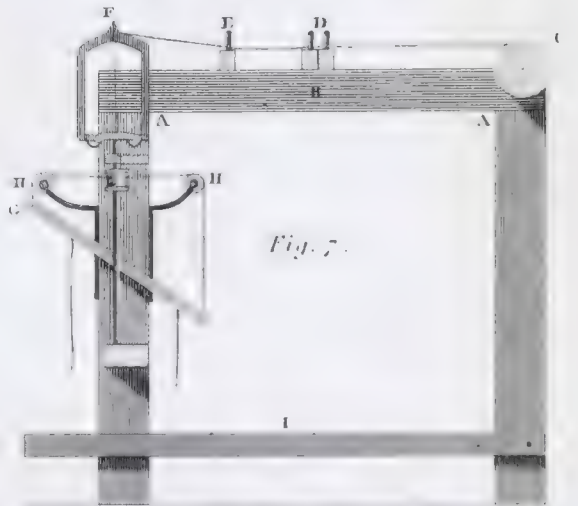


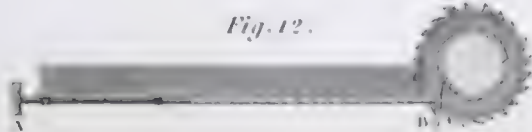
Fig. 10.



Fig. 11.



Fig. 12.

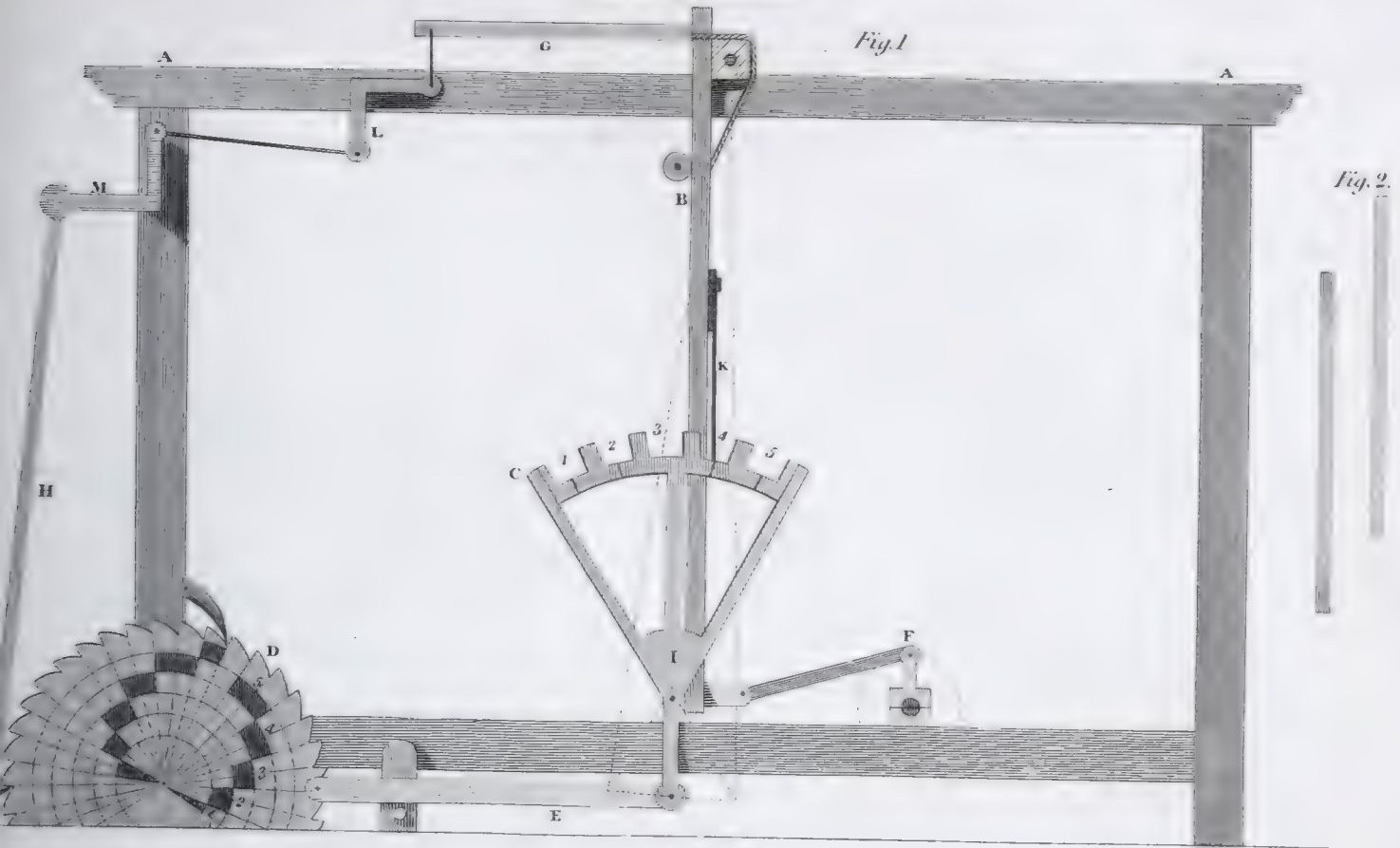




# CHECK. CHARACTER.

CHECK AND PULLICATE LAY FOR POWER LOOMS.

Invented by John Duncan.



## EXAMPLES OF DIFFERENT NUMERAL CHARACTERS.

HEBREW NUMERALS.		GREEK NUMERALS.			SPECIMEN OF THE GREEK MULTIPLICATION TABLE.												
א 1	ב 10	א 1	Β 10	Ϟ 100	α 1	Ι 10	Ϡ 100	α	β	γ	δ	ε	ς	ζ	η	θ	
ב 2	כ 20	β 2	Κ 20	σ 200	β	κ	σ	β	δ	ς	η	ι	ιβ	ιδ	ις	ιη	
ג 3	ל 30	γ 3	λ 30	τ 300	γ	λ	τ	γ	ς	θ	ιβ	ιδ	ιη	κα	κς	κζ	
ד 4	מ 40	δ 4	μ 40	υ 400	δ	μ	υ	δ	η	ιβ	ις	κ	κς	κη	λβ	λς	
ה 5	נ 50	ε 5	ν 50	φ 500	ε	ν	φ	ε	ι	ιδ	κ	κε	λ	λε	μ	με	
ו 6	ס 60	ς 6	ξ 60	χ 600	ς	ξ	χ	ς	ιβ	μ	κς	λ	λς	μβ	μη	νδ	
ז 7	ע 70	ζ 7	ο 70	ψ 700	ζ	ο	ψ	ζ	ιδ	κ	κς	λ	λς	μβ	μη	νδ	
ח 8	פ 80	η 8	ω 80	ω 800	η	ω	ω	η	κ	κα	κη	λδ	μβ	μθ	νς	ξγ	
ט 9	צ 90	θ 9	ς 90	λ 900	θ	ς	λ	θ	ις	κς	λβ	μ	μη	νς	ξδ	οβ	
קכ 84	קכקכ 1812	αωιβ	1812						ο	ιη	κζ	λς	μδ	νδ	ξγ	οβ	πα

ANCIENT ARABIC NUMERALS.		INDIAN NUMERALS.		SIAMESE NUMERALS.		TAMULIAN OR MALABARIC NUMERALS.			
1	1	1	1	1	1	1	2	3	4
2	2	2	2	2	2	5	6	7	8
3	3	3	3	3	3	10	11	12	13
4	4	4	4	4	4	14	15	16	17
5	5	5	5	5	5	18	19	20	21
6	6	6	6	6	6	22	23	24	25
7	7	7	7	7	7	26	27	28	29
8	8	8	8	8	8	30	31	32	33
9	9	9	9	9	9	34	35	36	37
10	10	10	10	10	10	38	39	40	41
11	11	11	11	11	11	42	43	44	45
12	12	12	12	12	12	46	47	48	49
13	13	13	13	13	13	50	51	52	53
14	14	14	14	14	14	54	55	56	57
15	15	15	15	15	15	58	59	60	61
16	16	16	16	16	16	62	63	64	65
17	17	17	17	17	17	66	67	68	69
18	18	18	18	18	18	70	71	72	73
19	19	19	19	19	19	74	75	76	77
20	20	20	20	20	20	78	79	80	81
21	21	21	21	21	21	82	83	84	85
22	22	22	22	22	22	86	87	88	89
23	23	23	23	23	23	90	91	92	93
24	24	24	24	24	24	94	95	96	97
25	25	25	25	25	25	98	99	100	101





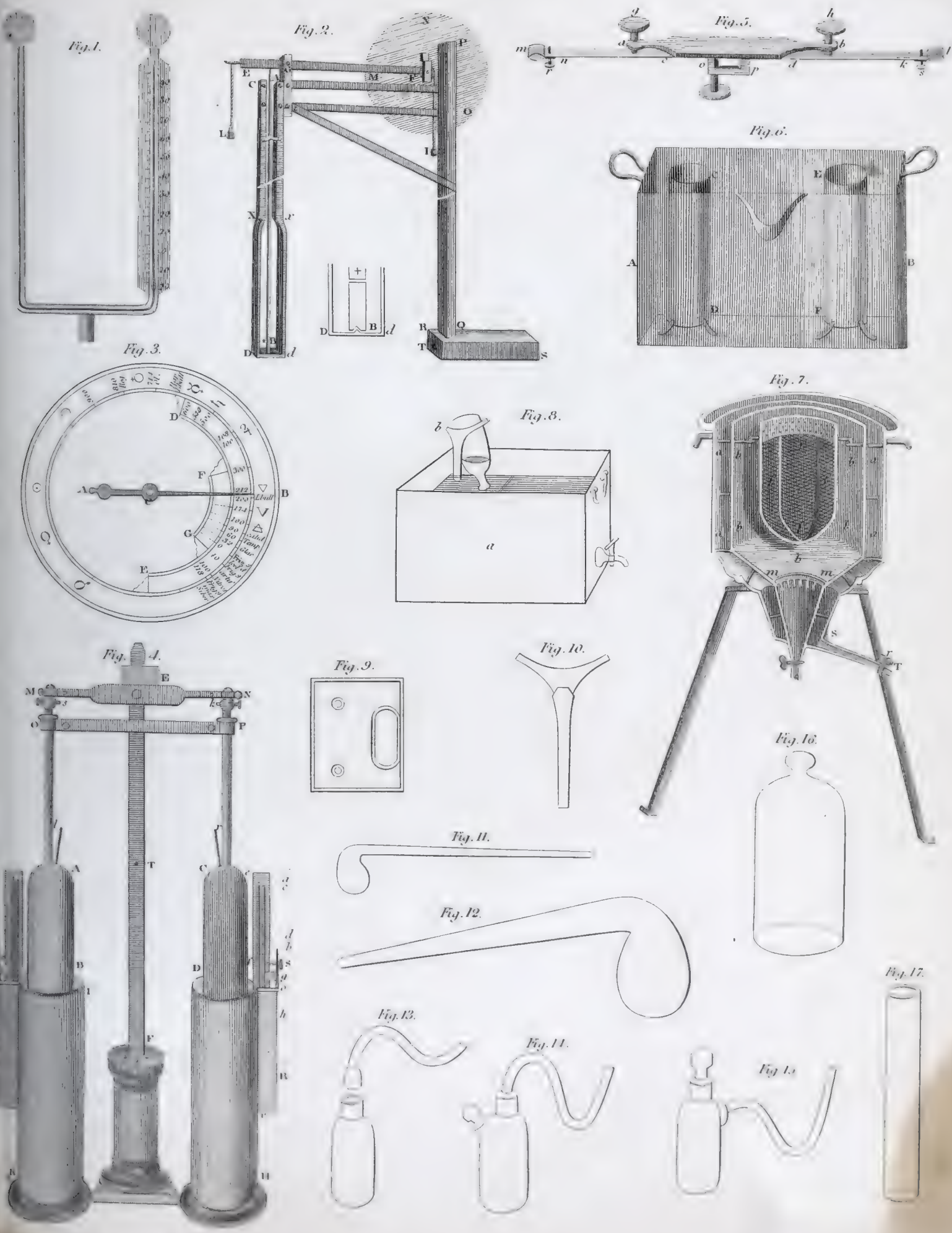




Fig. 1.



Fig. 7.

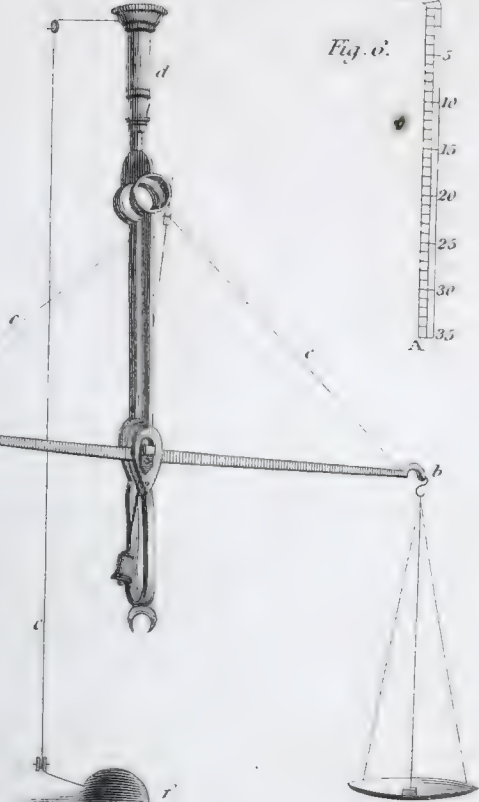


Fig. 6.

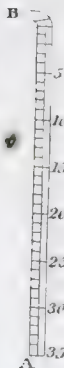


Fig. 10.

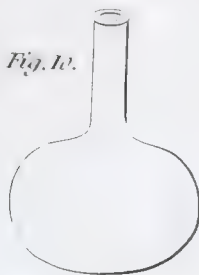


Fig. 5.

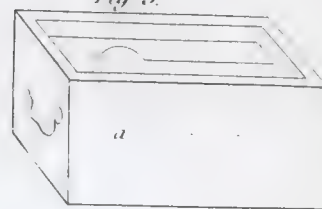
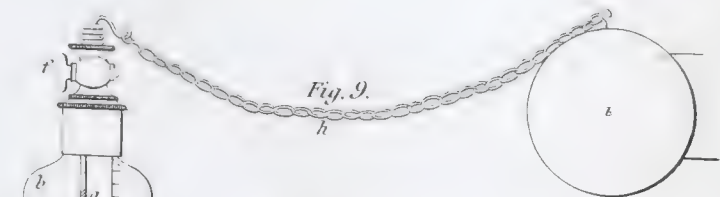


Fig. 9.



Gaxometer for Oxygen Gas.

Fig. 2.



Fig. 3.

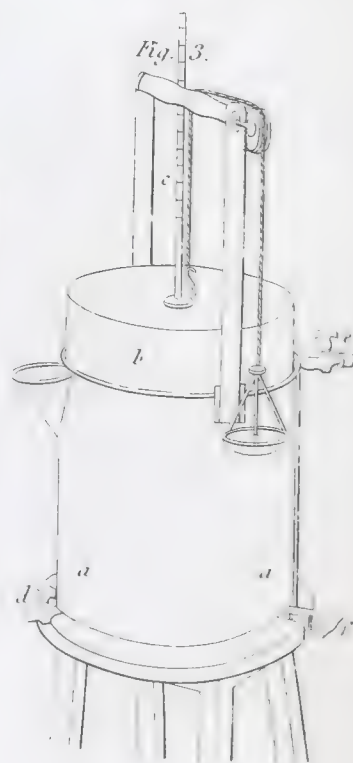


Fig. 4.

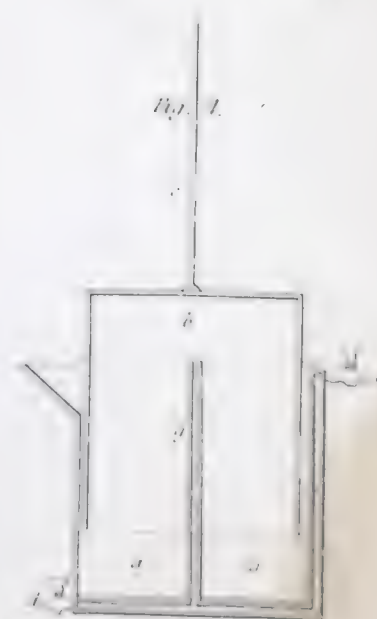
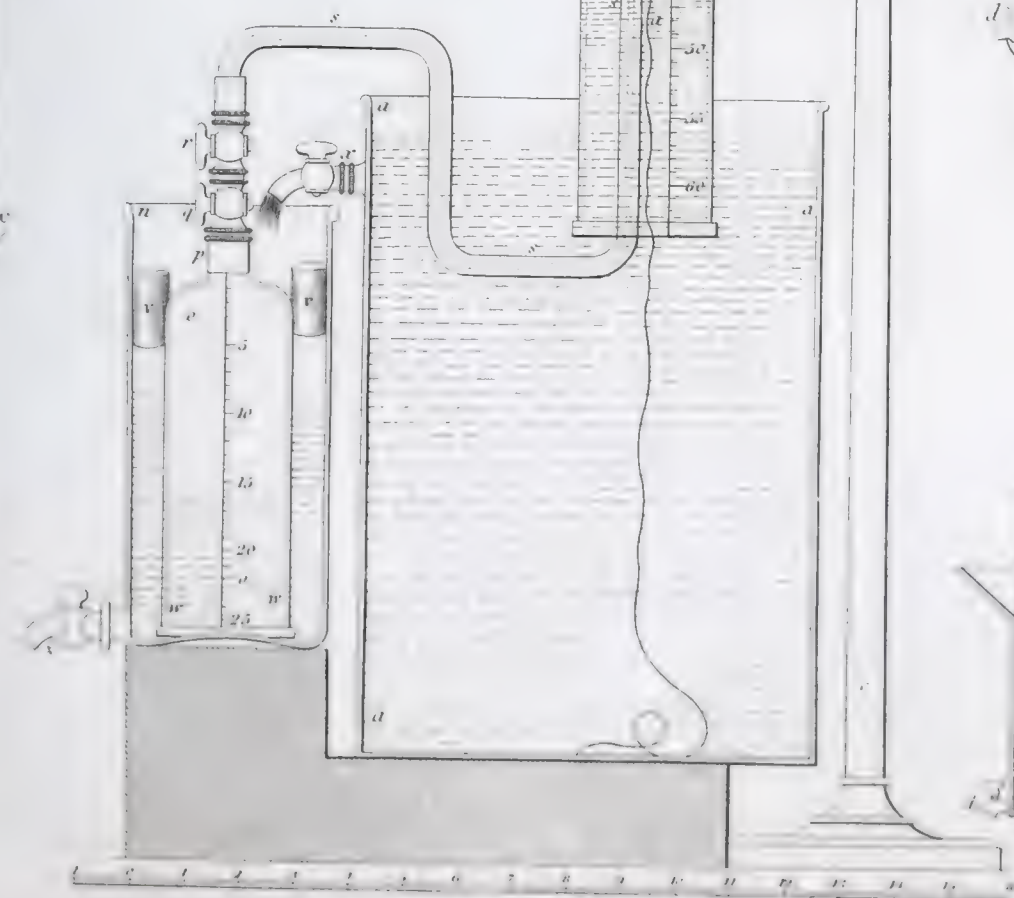


Fig. 8.





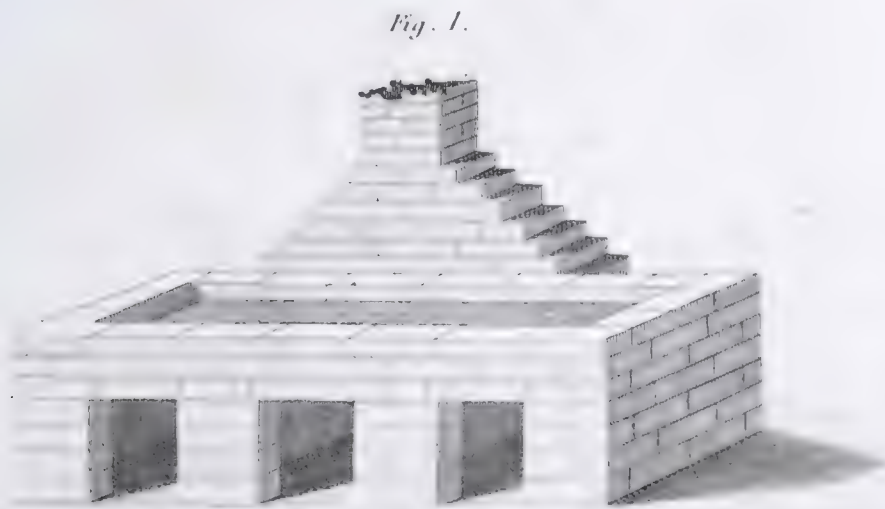
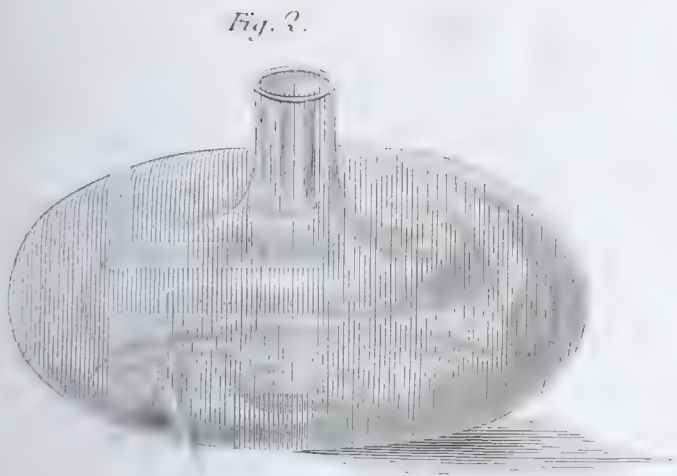
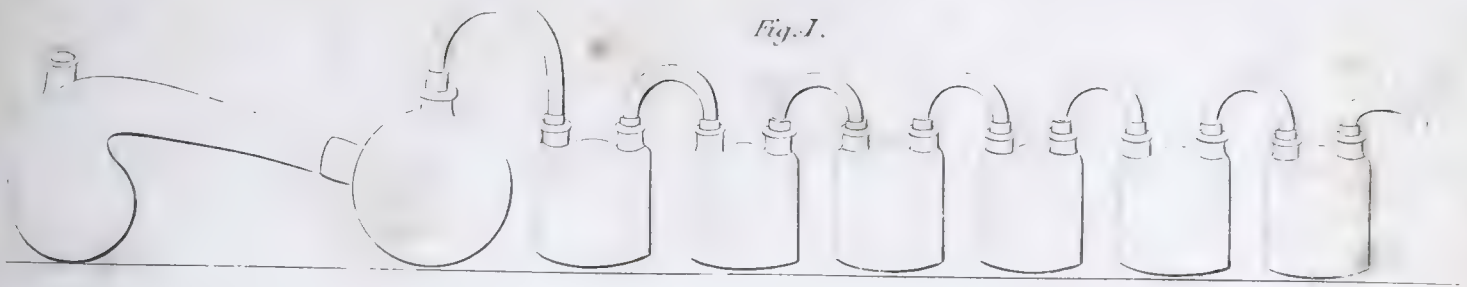




Fig. 2.

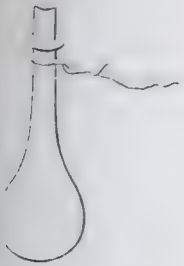


Fig. 3.



Fig. 3.



Fig. 4.

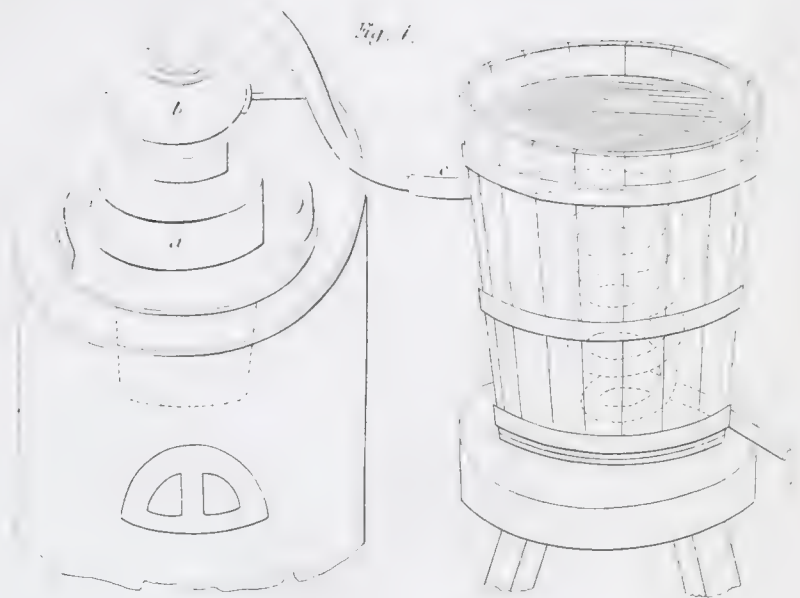


Fig. 7.

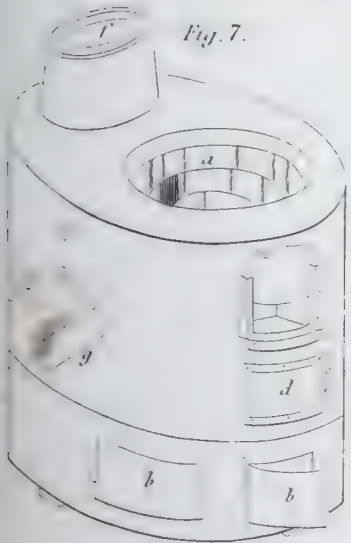


Fig. 5.



Fig. 9.

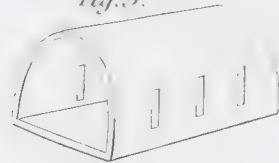


Fig. 14.



Fig. 8.



Fig. 6.

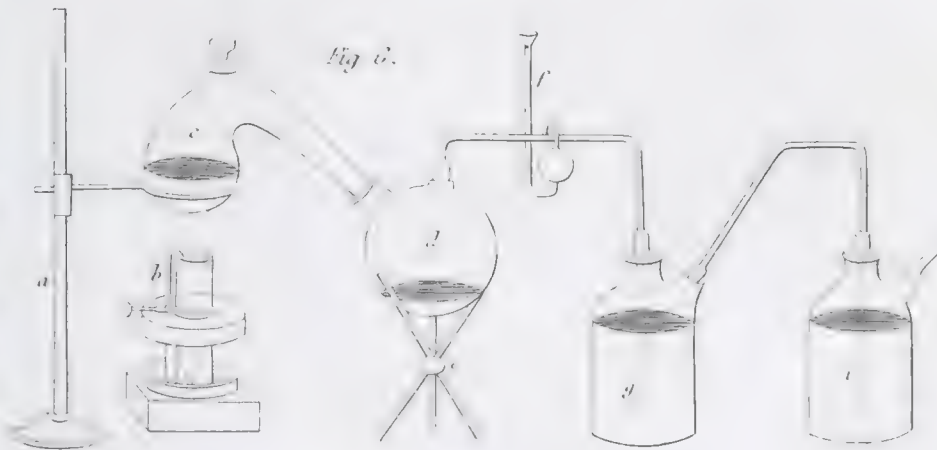


Fig. 15.



Fig. 17.



Fig. 10.



Fig. 11.



Fig. 12.



Fig. 17.



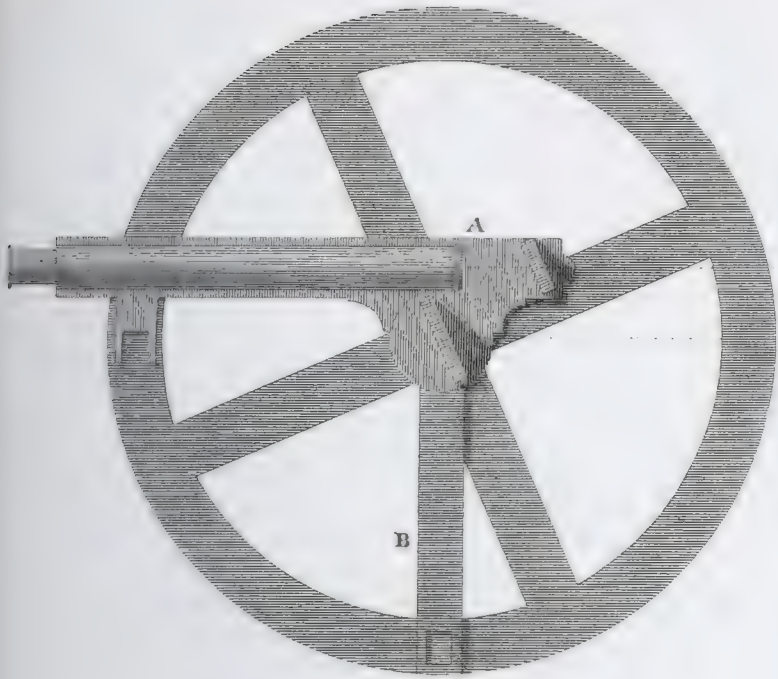
Fig. 13.



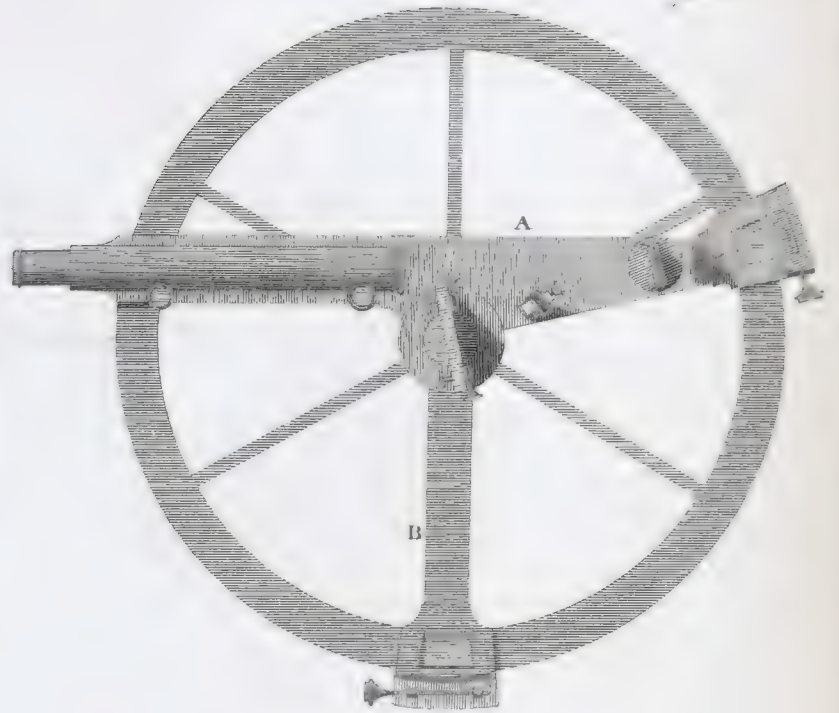




*Fig. 1.*



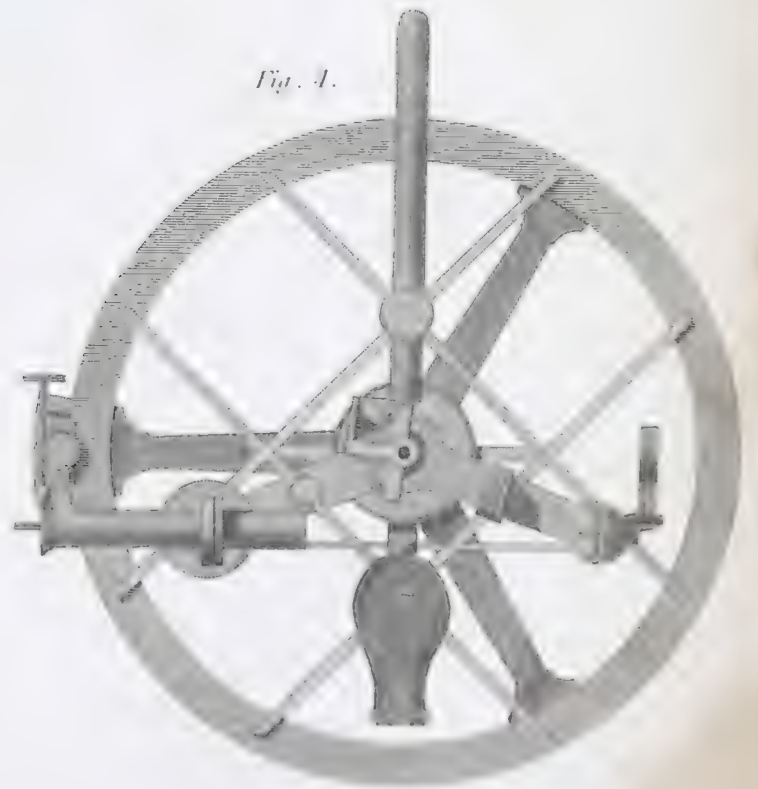
*Fig. 2.*



*Fig. 3.*



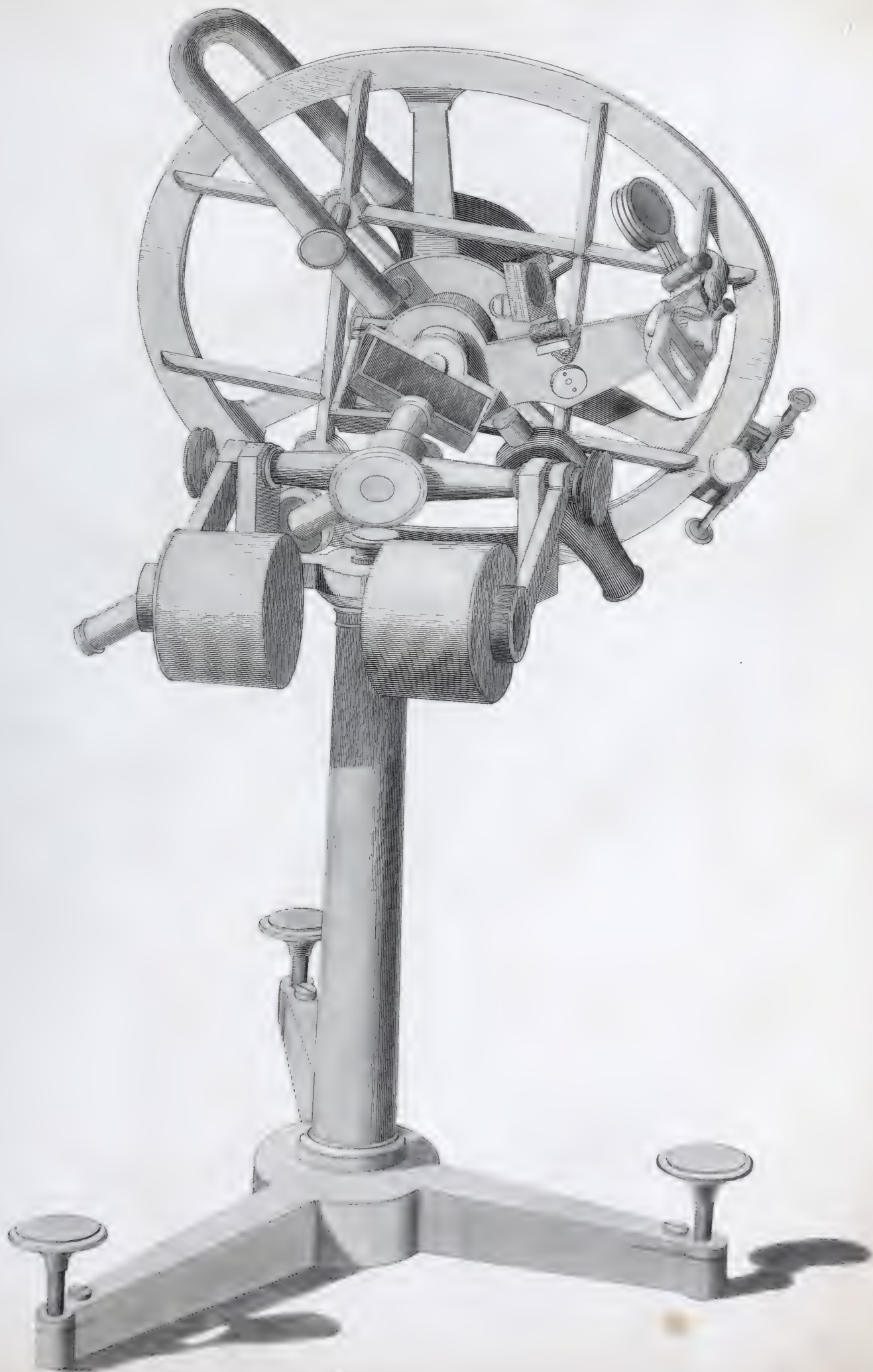
*Fig. 4.*





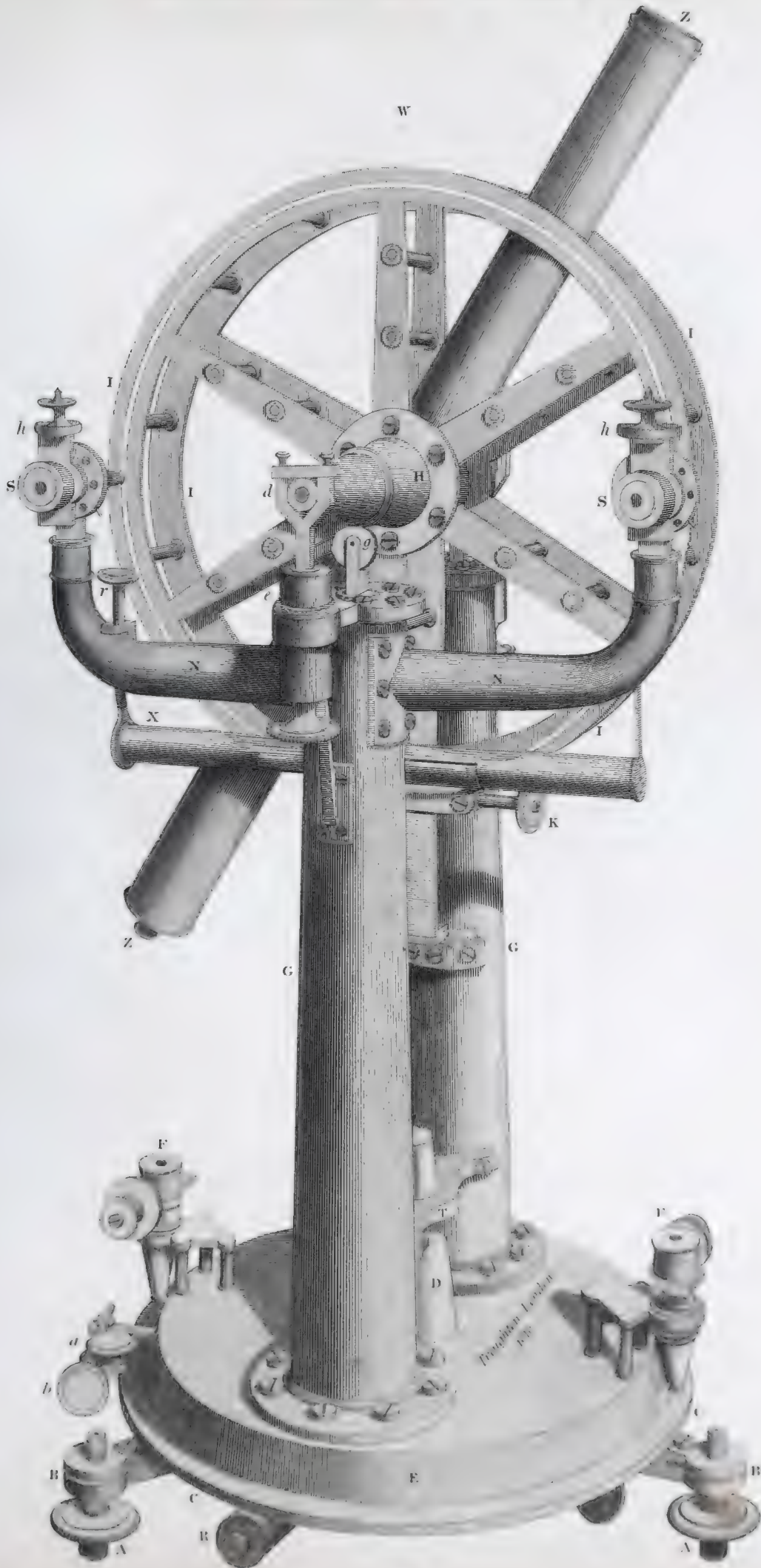
CIRCLE.

TROUGHTON'S REFLECTING CIRCLE.





TROUGHTON'S PORTABLE ALTITUDE AND AZIMUTH CIRCLE.





CIRCLE.

REPEATING CIRCLE.







*Portico of the Temple of Teutyris*



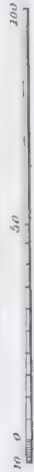
*Interior Door of the Temple of Teutyris*



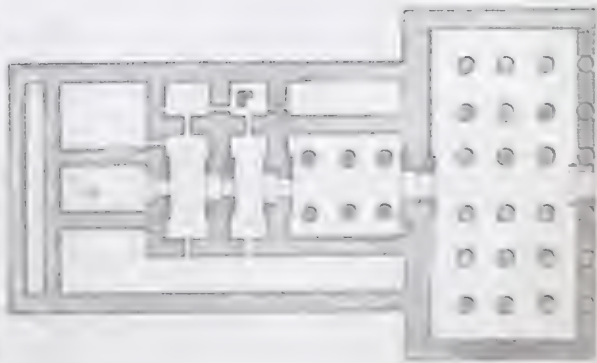
*Scale of Feet for Elevations of Teutyris & Latopolis*



*Scale for Plans of d'*



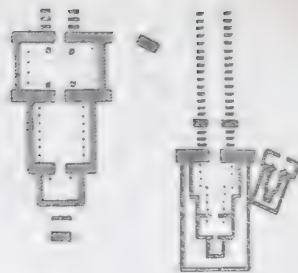
*Plan of the Temple of Teutyris*



*Entrance to the Temple of Karnaq*

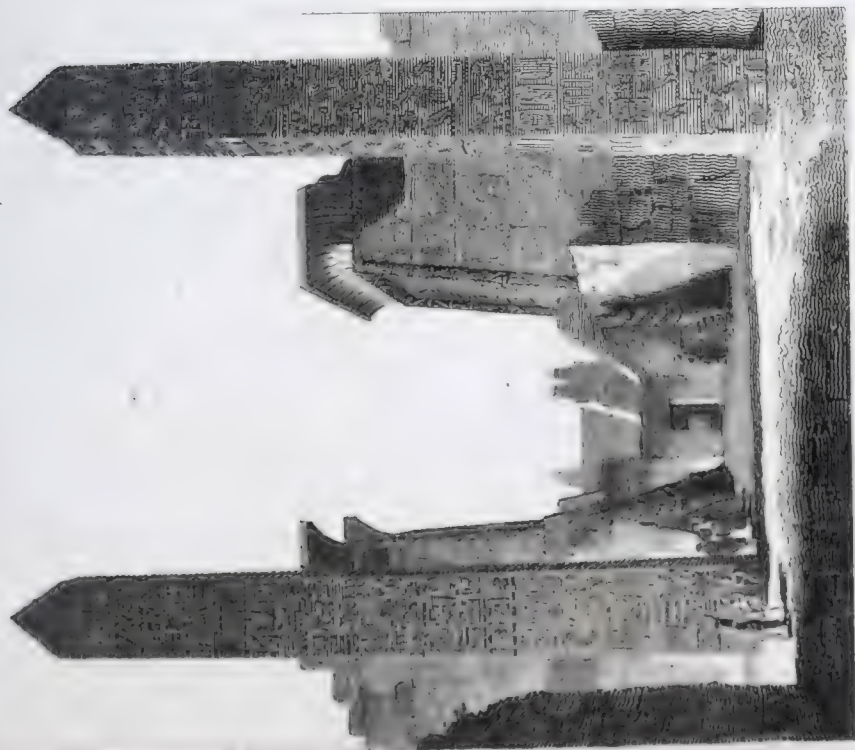


*Plan of the Temple of Karnaq*

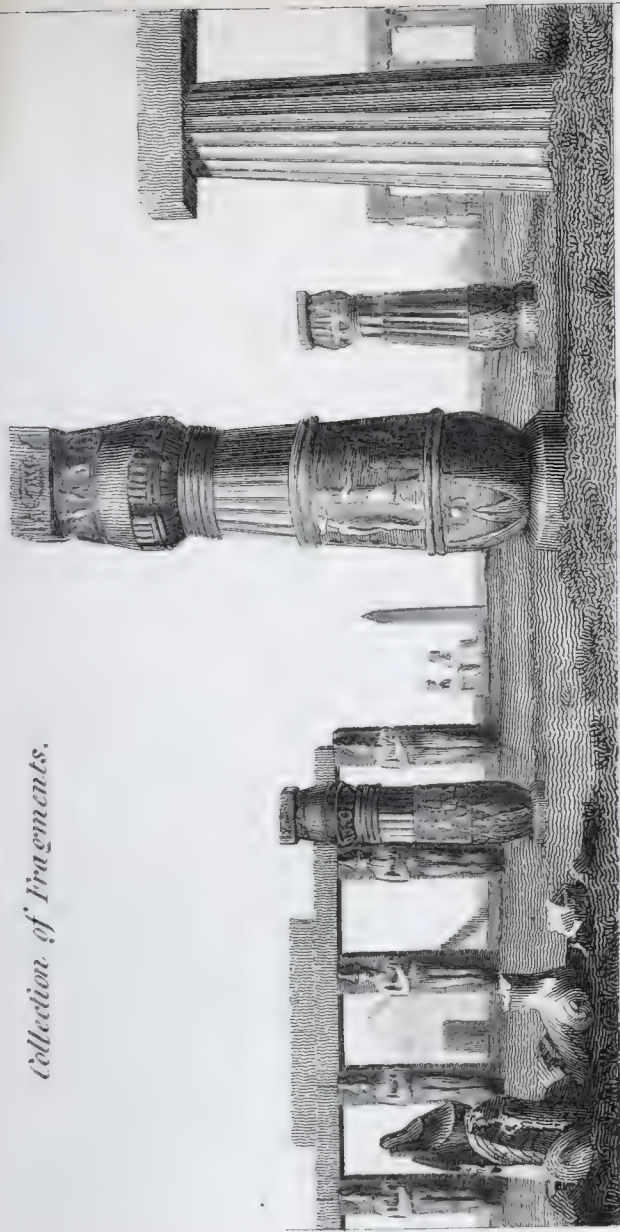




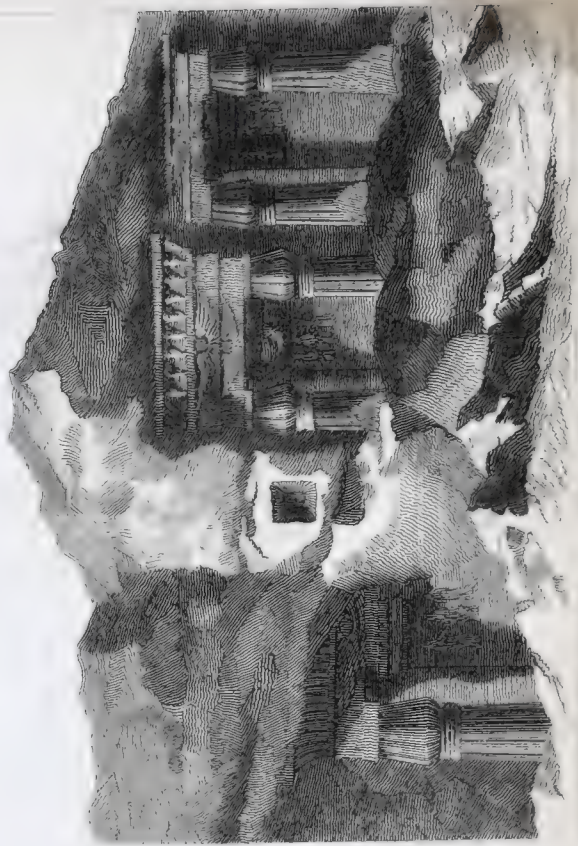
*Entrance to Luxor.*



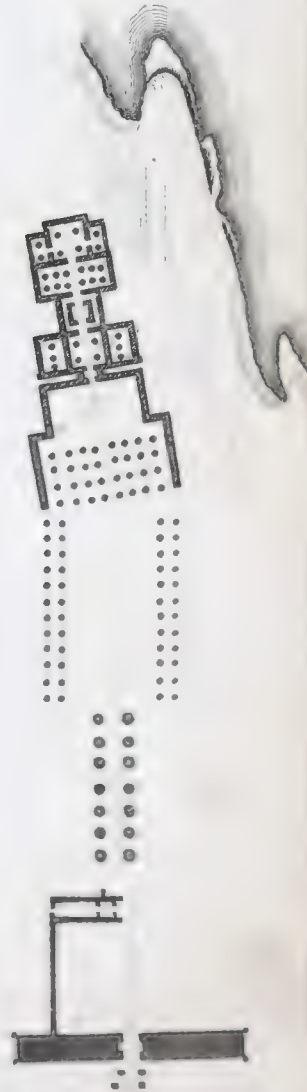
*Collection of Fragments.*



*Tomb of Sitsutis.*

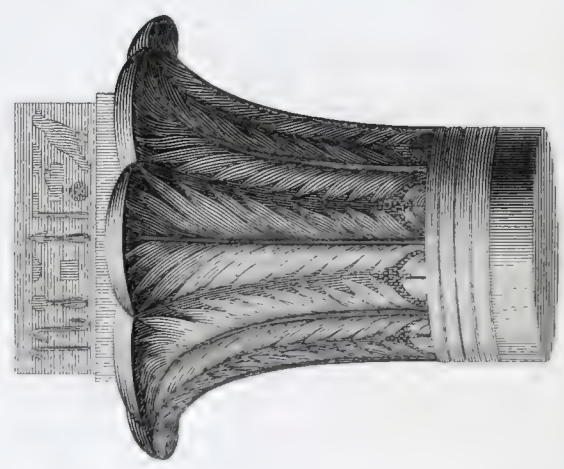
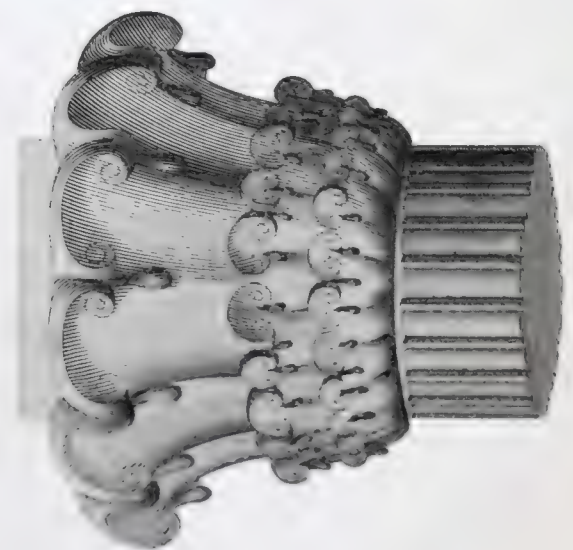
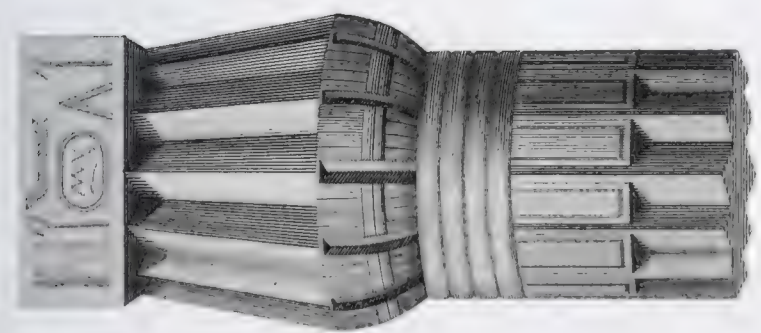


*Plan of the Temple of Luxor.*



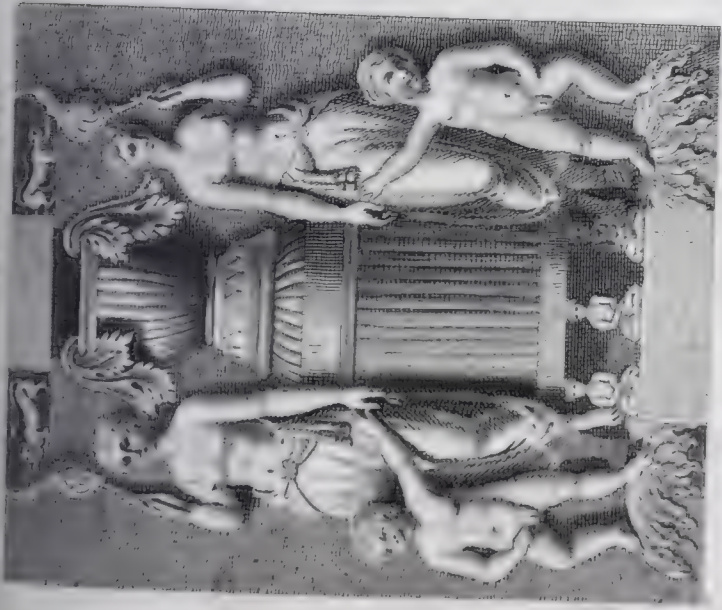


EGYPTIAN CAPITALS.

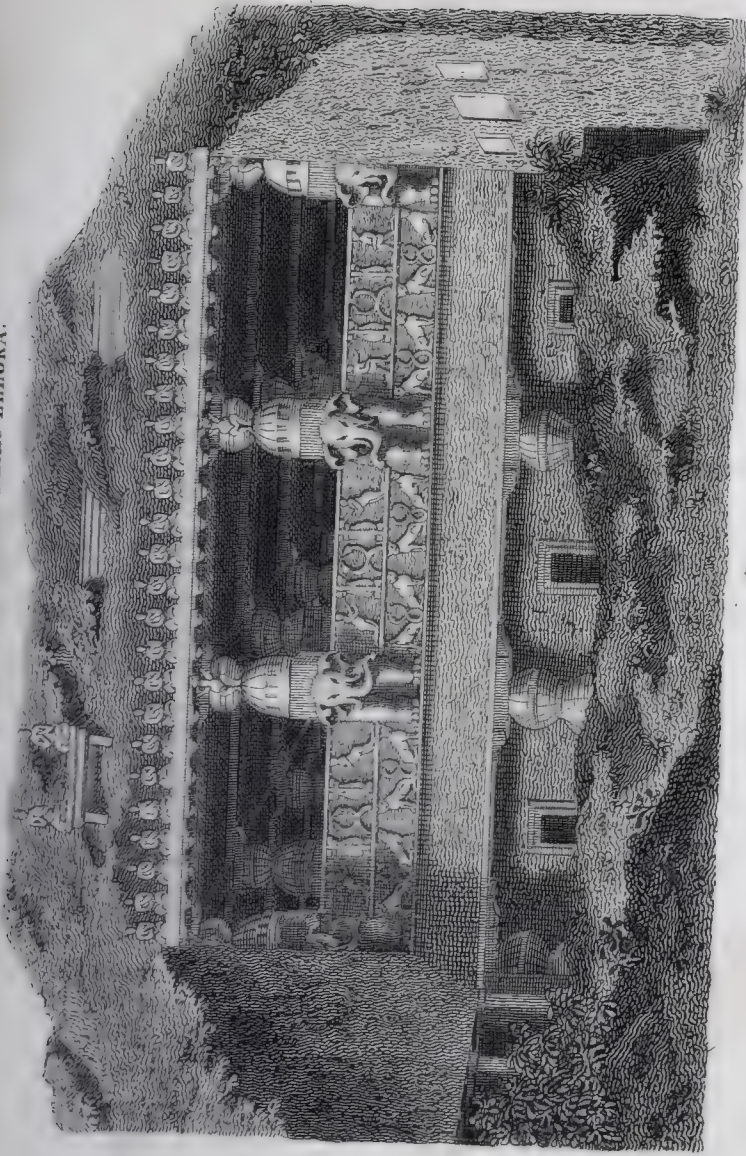




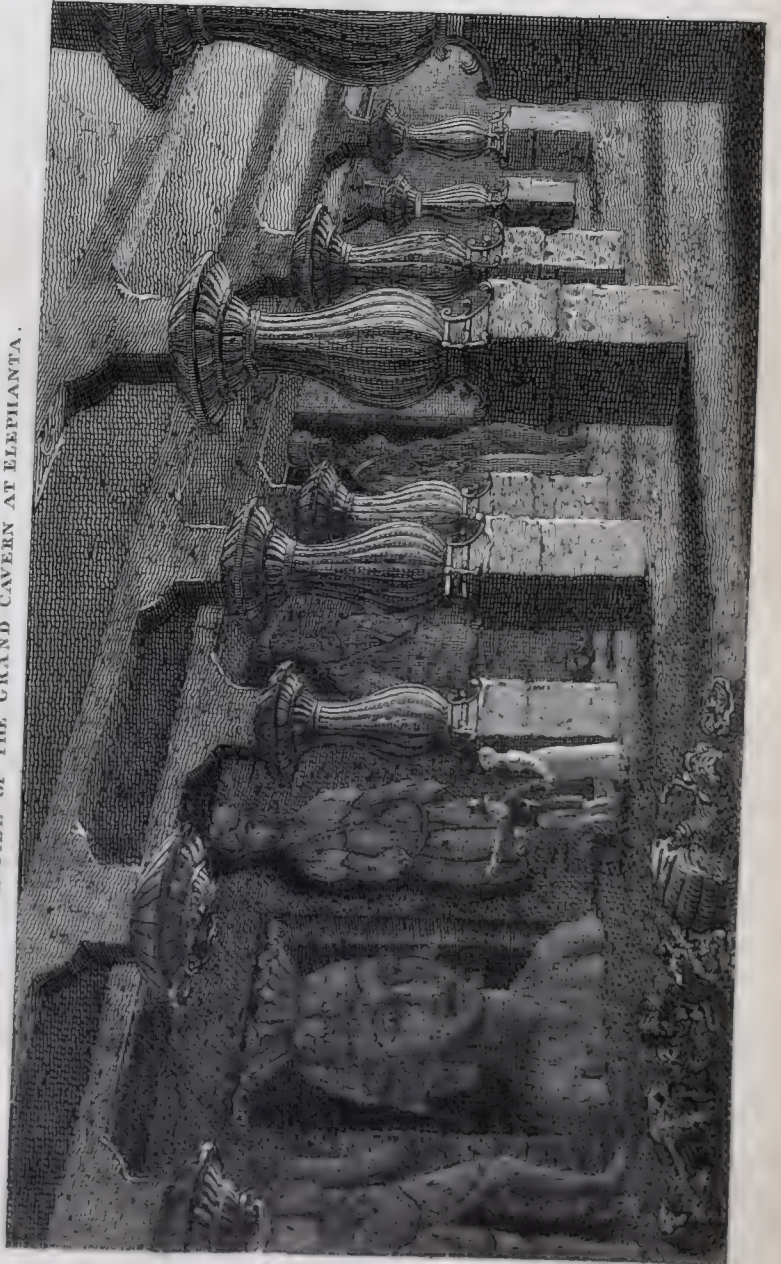
DOOR OF THE TEMPLE OF JUNWASSOR.



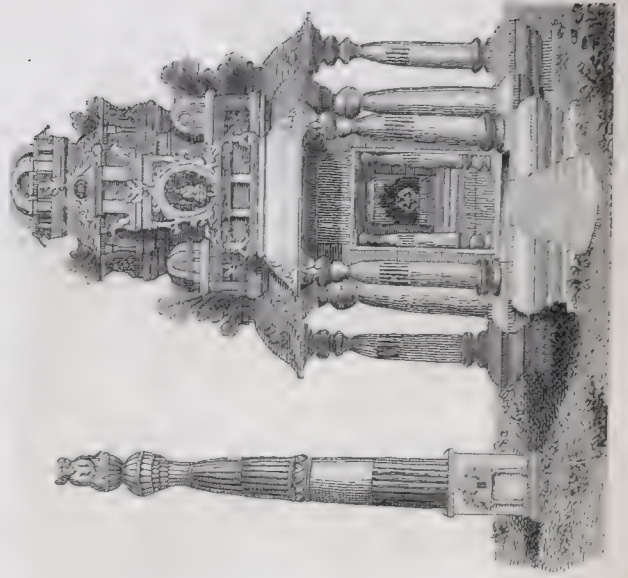
CAVE OF JUGNATH SUBBA NEAR ELLORA.



INSIDE OF THE GRAND CAVERN AT ELEPHANTA.



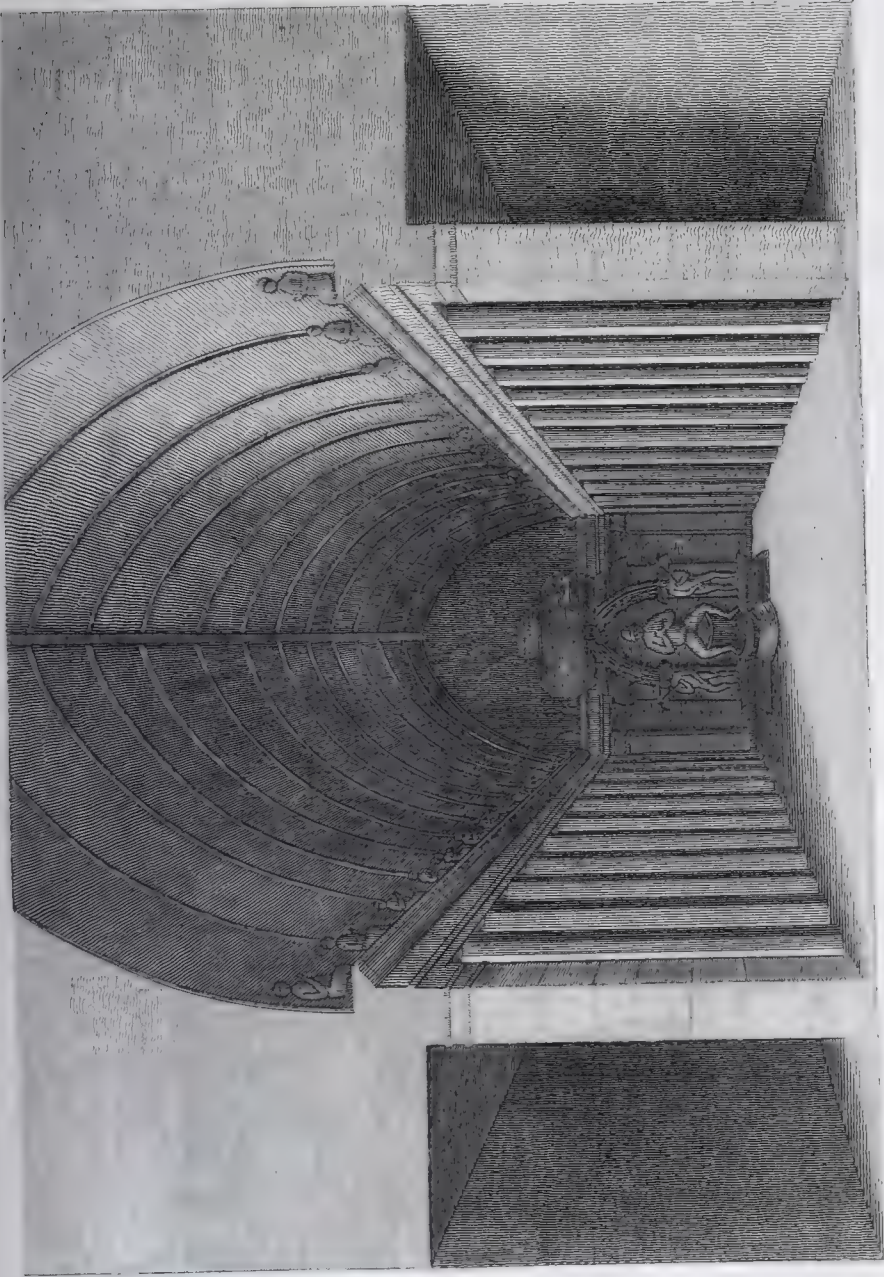
INDUR SUBBA (THE TEMPLE)



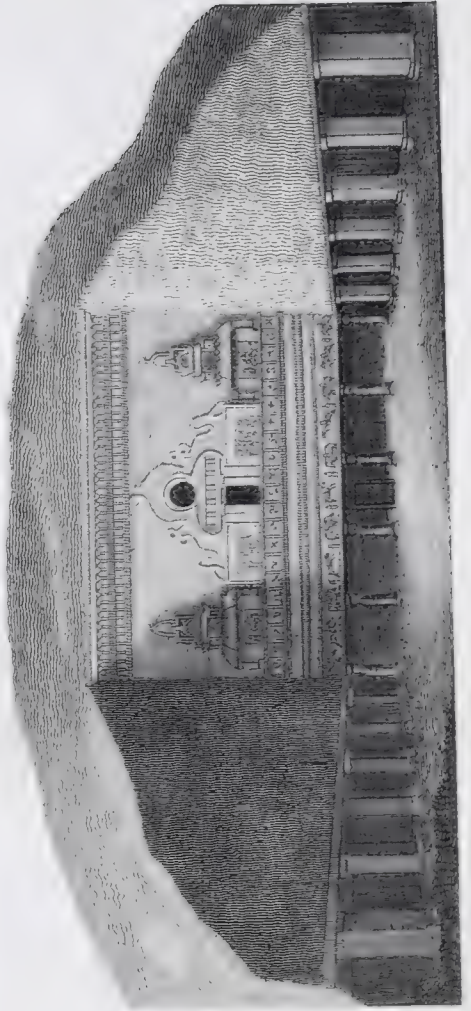




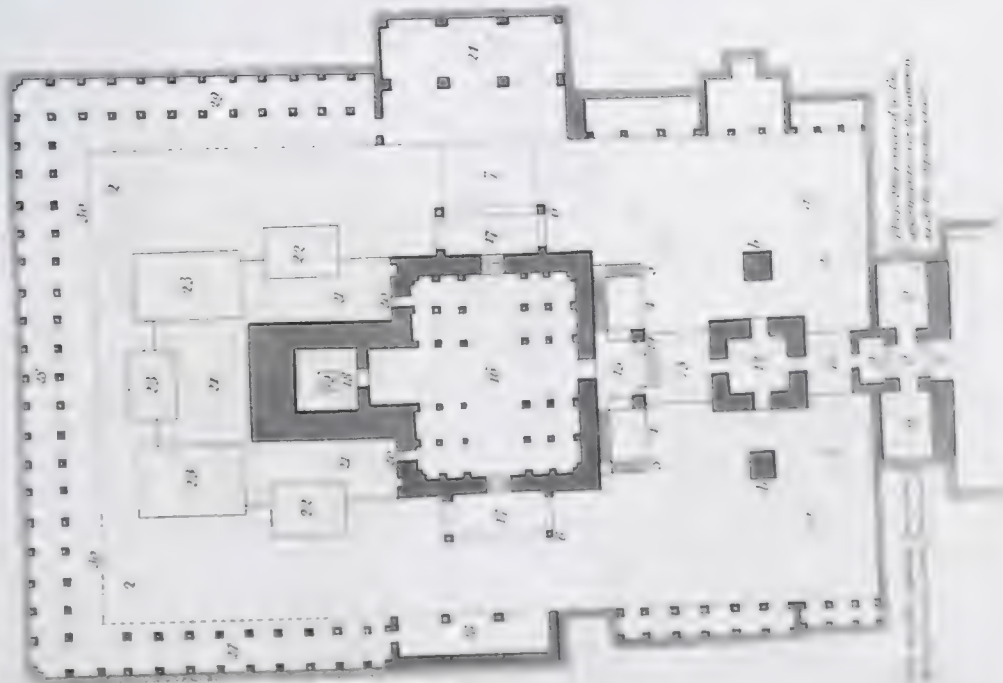
INTERIOR OF BISKURMA, OR VISWAKURMA KA JOMPREE.



BISKURMA OF VISWAKURMA KA JOMPREE.



PLAN OF THE GRAND TEMPLE, KETLAJ.



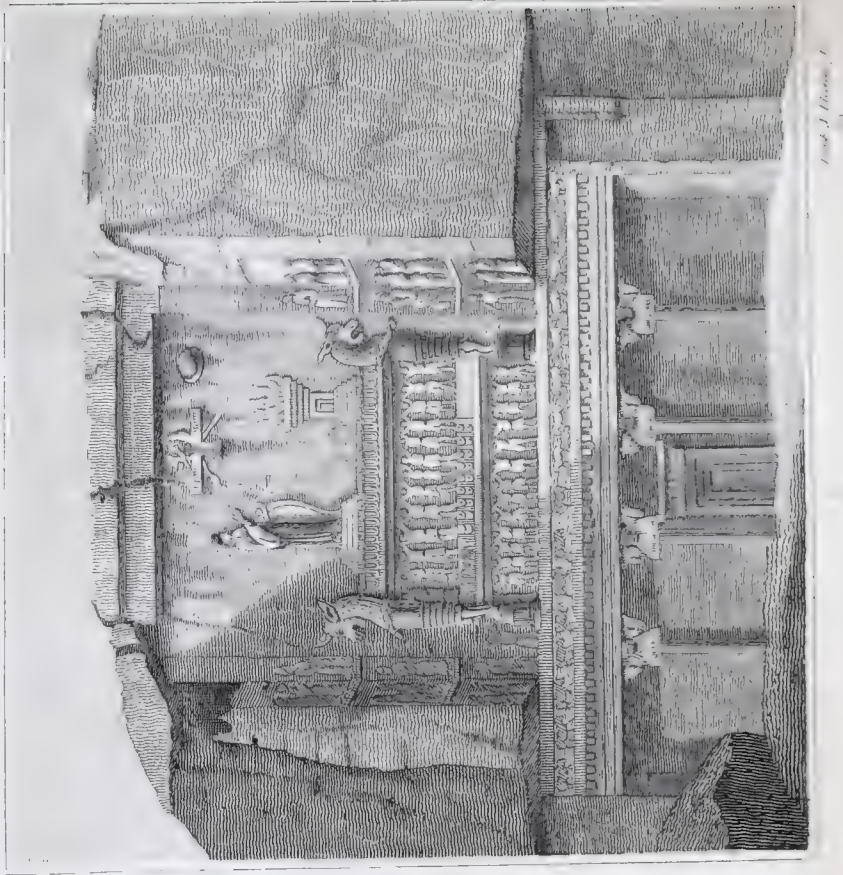




*Western Portico. — Persepolis*

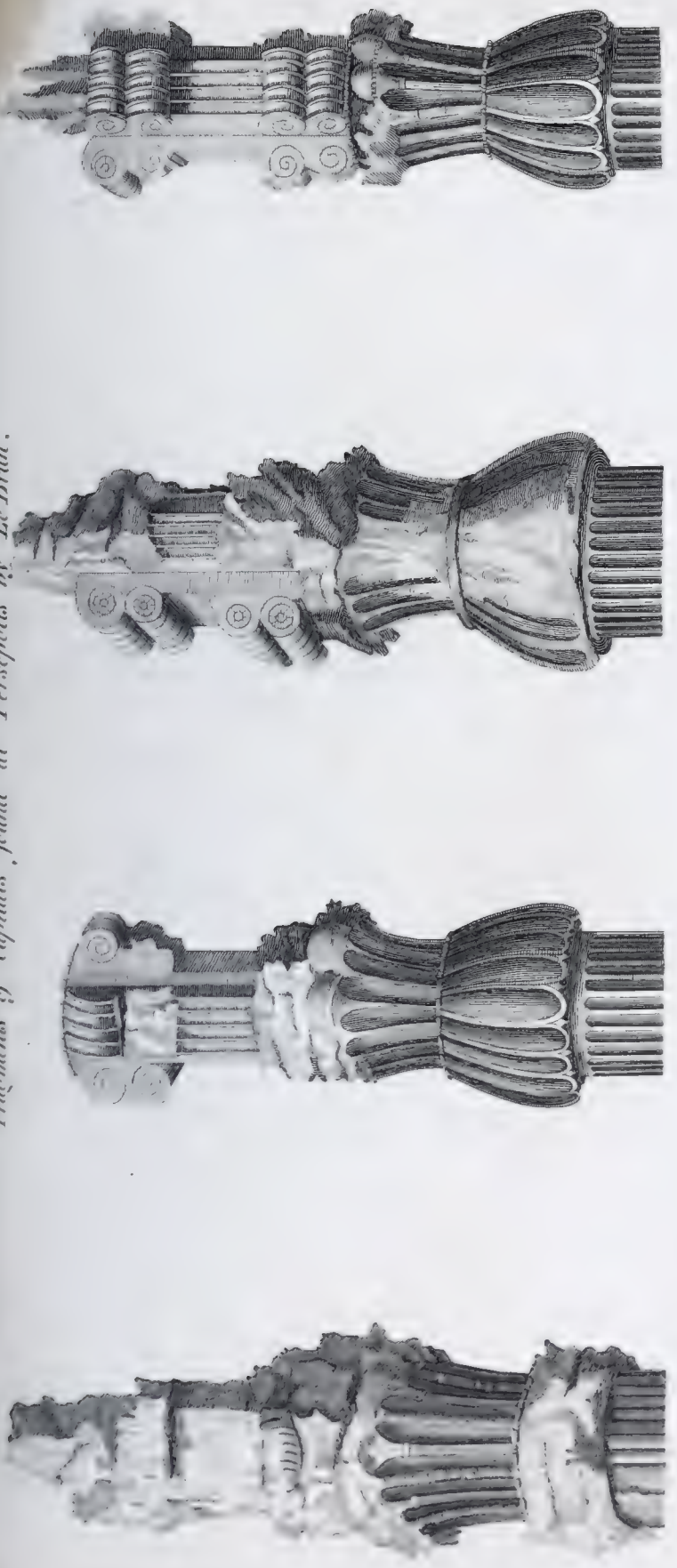


*Tomb of the Kings*

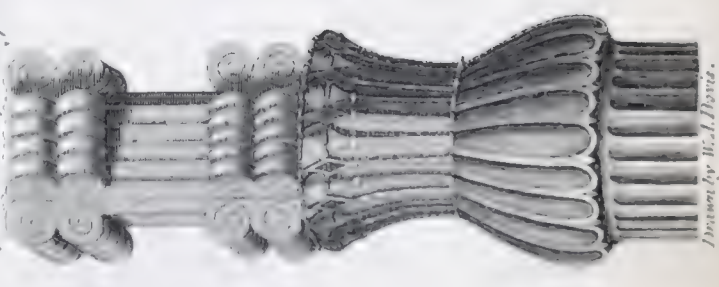




*Fragments of Capitals found at Persepolis by Le Brun.*

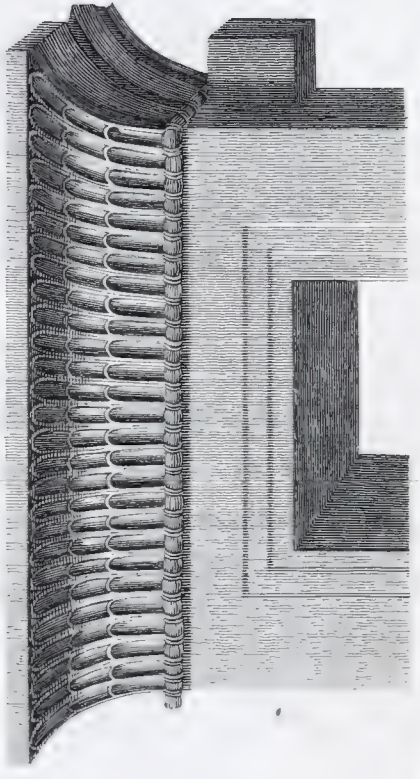


*A perfect Capital compared from the above.*

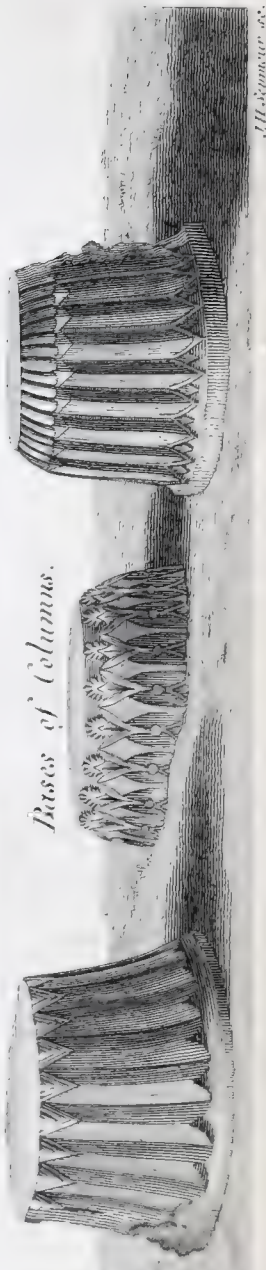


*Drawn by W. A. Davis.*

*Top of a doorway.*



*Bases of Columns.*

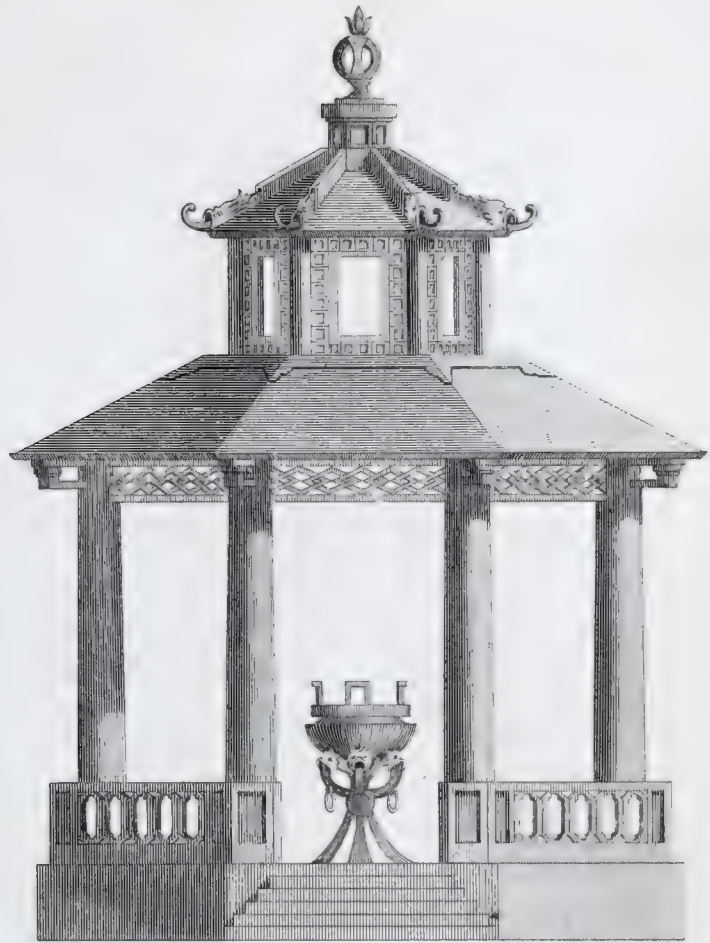


*J. H. Stanger sc.*





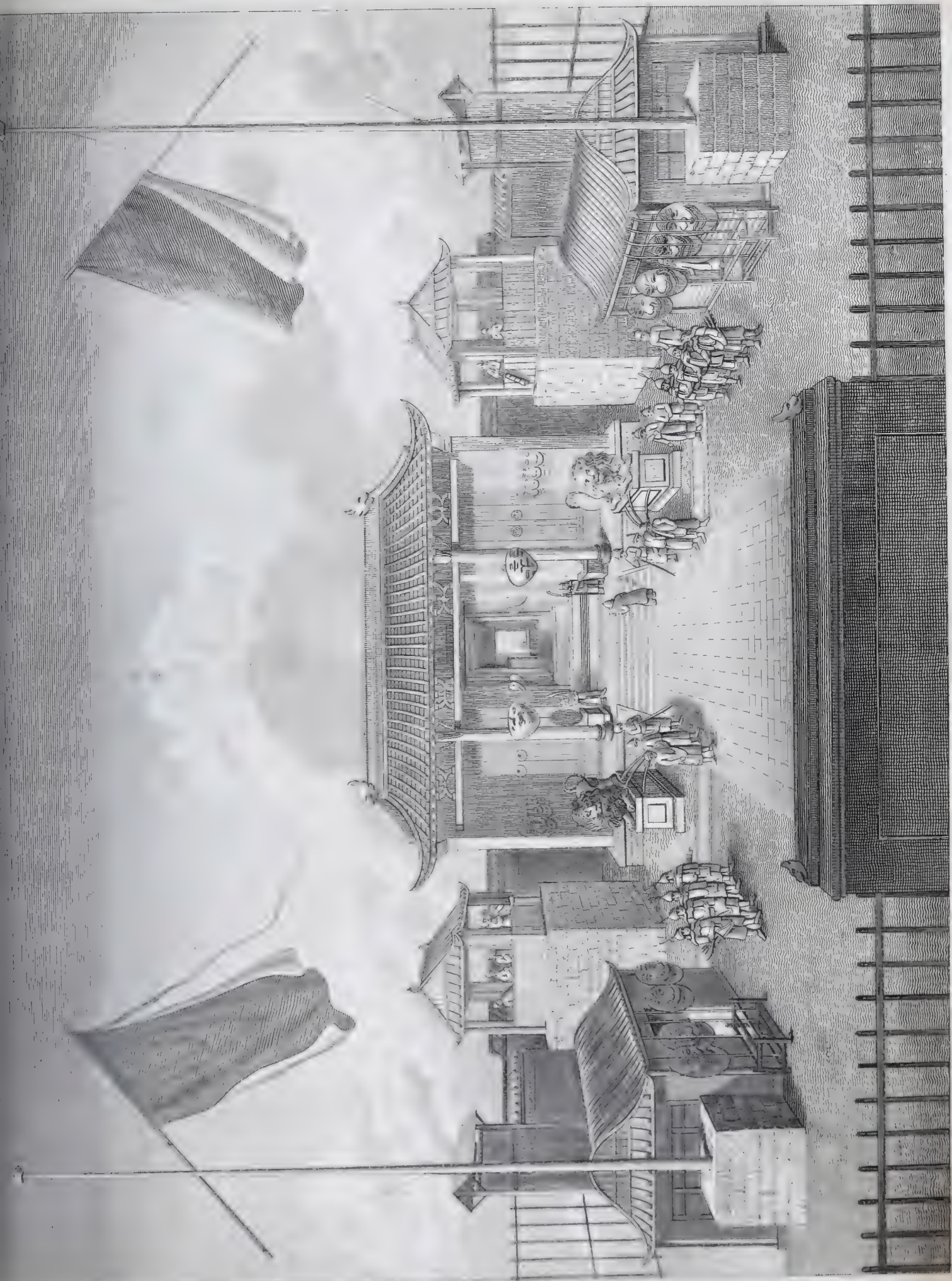
*Octagonal Pagoda on the Shore of the Ta-Ho Great River  
between Canton and Hoang Pou.*



*Two Octagonal Temples in the Court of one of the Pagoda's  
in the West Suburb of Canton.*



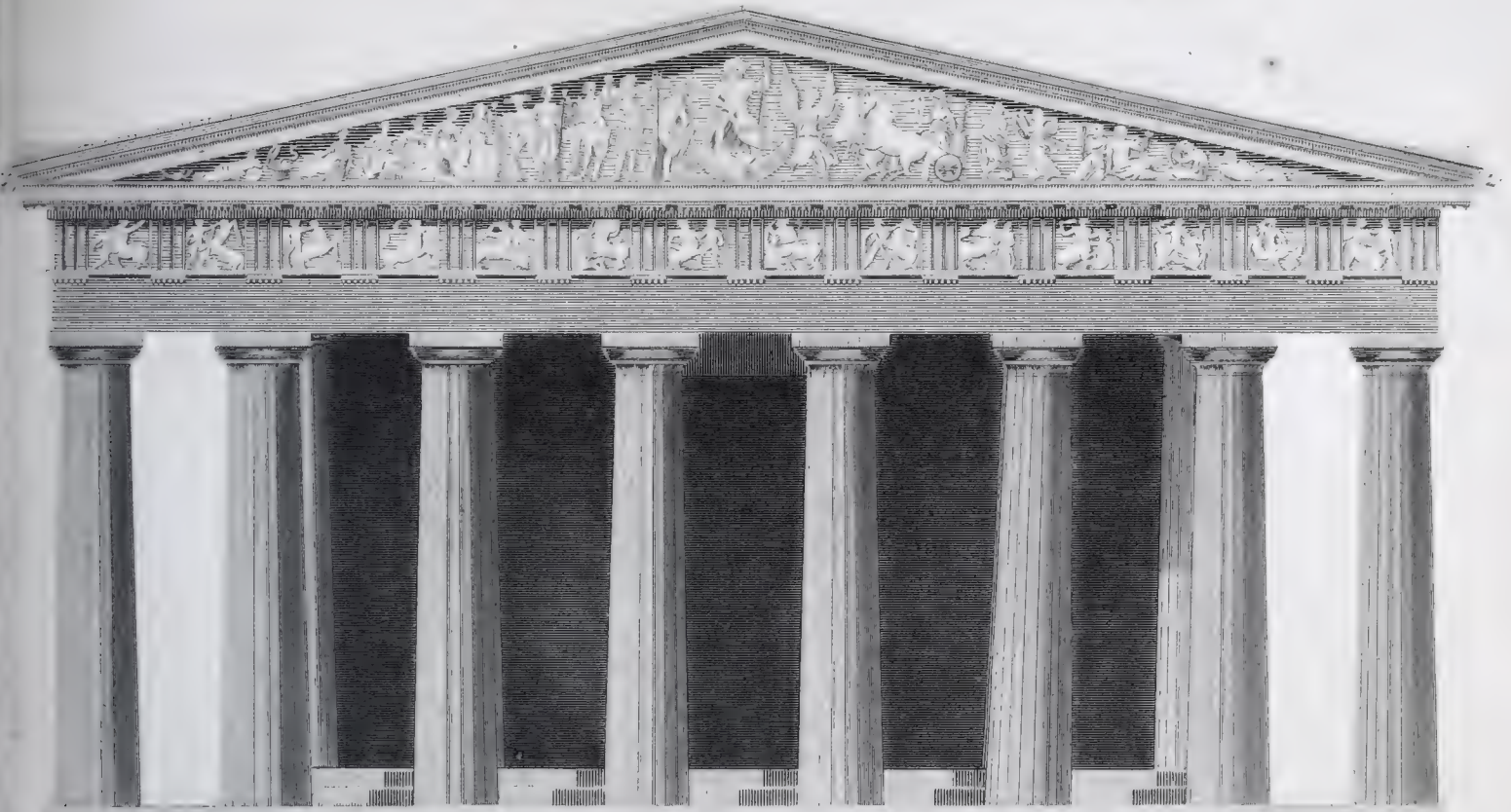




*From an engraving drawn by a Chinese*

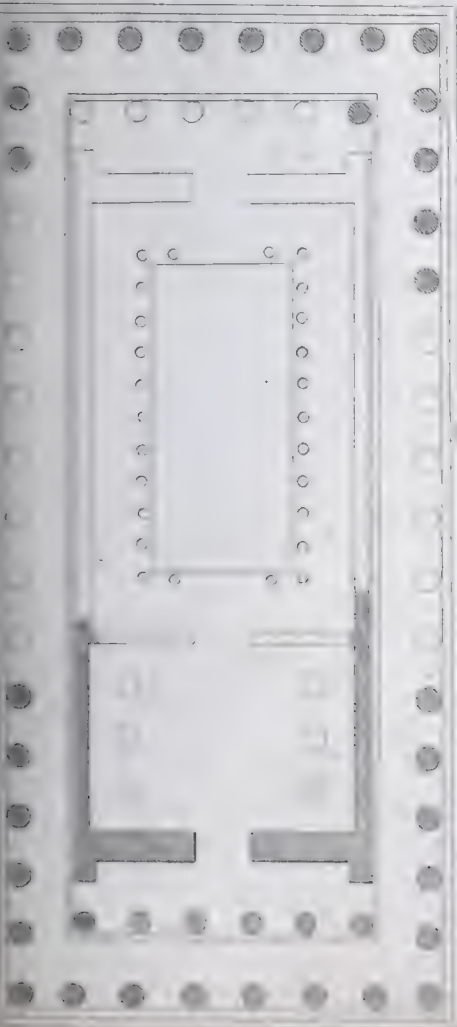


*Elevation of the Temple of Minerva Parthenon at Athens, as restored by M<sup>r</sup> Stuart.*



20' 0' 20' 20' 30' 40 Feet

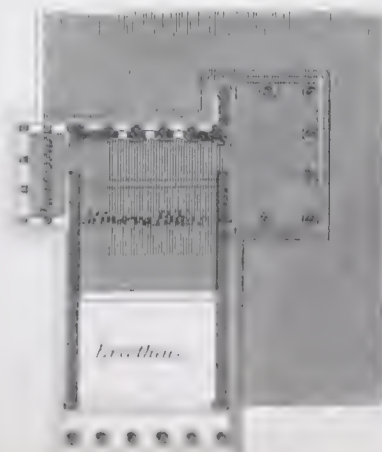
*Plan of the above as found by M<sup>r</sup> Stuart.*



*Elevation of the Temples of Erechtheus, Minerva Polias and Pandrosus.*

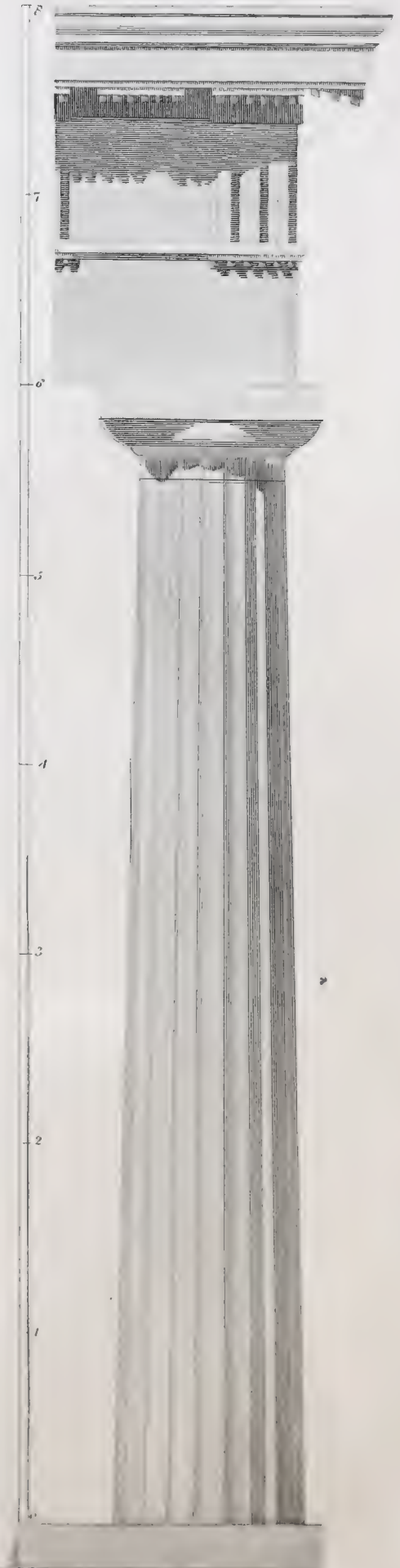
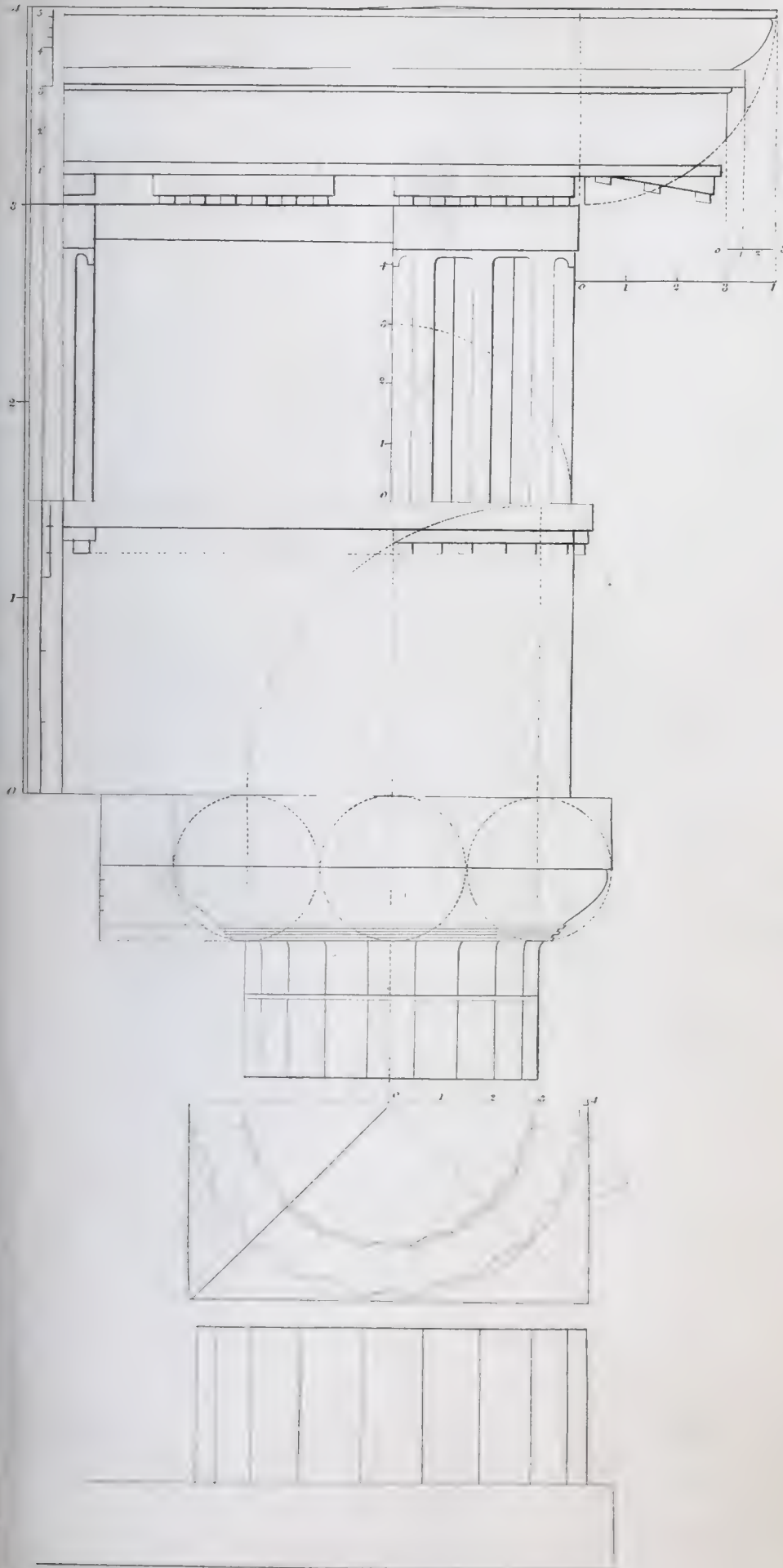


20' 0' 20' 20' Feet





DORIC ORDER.





IONIC ORDER.

Fig. 2

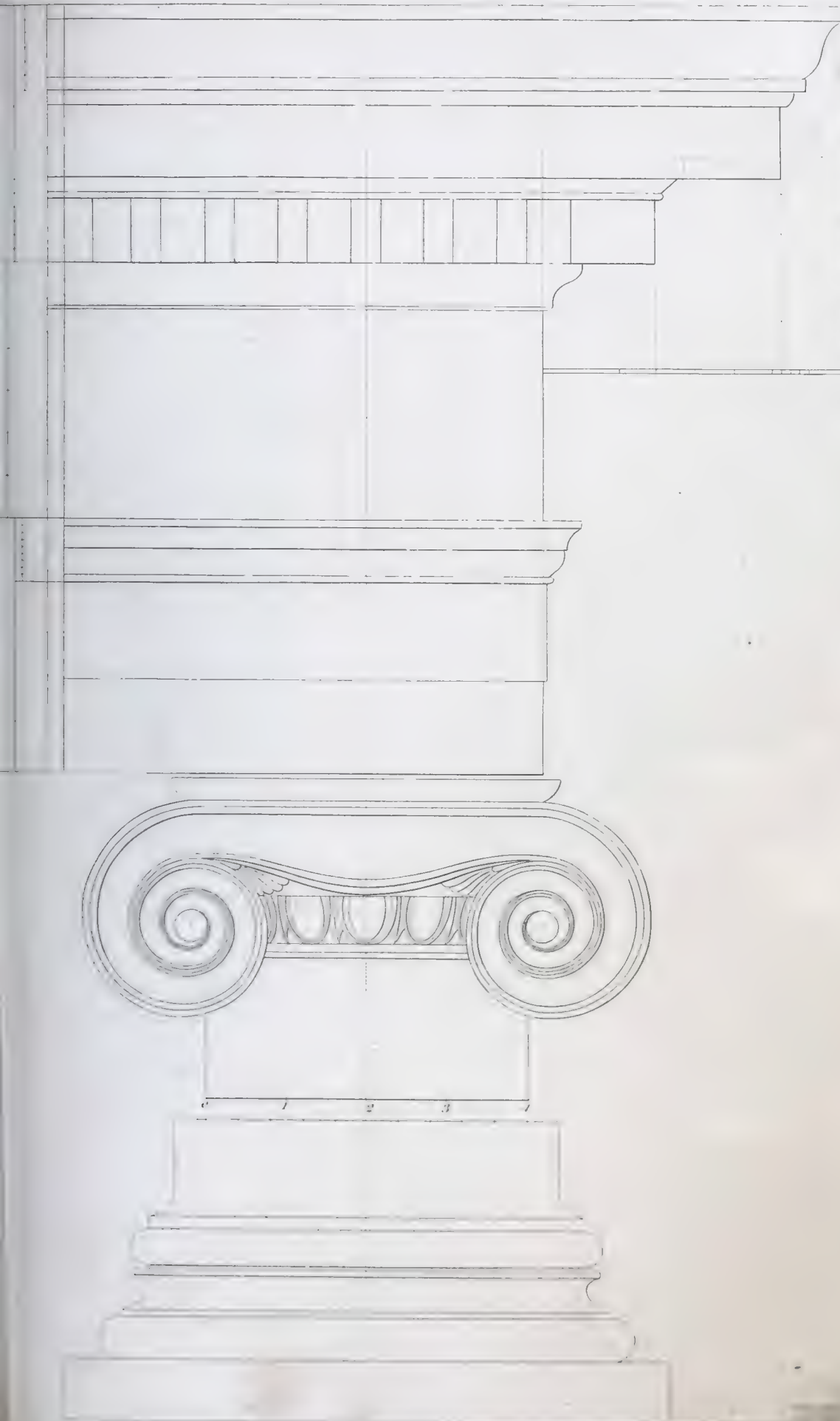


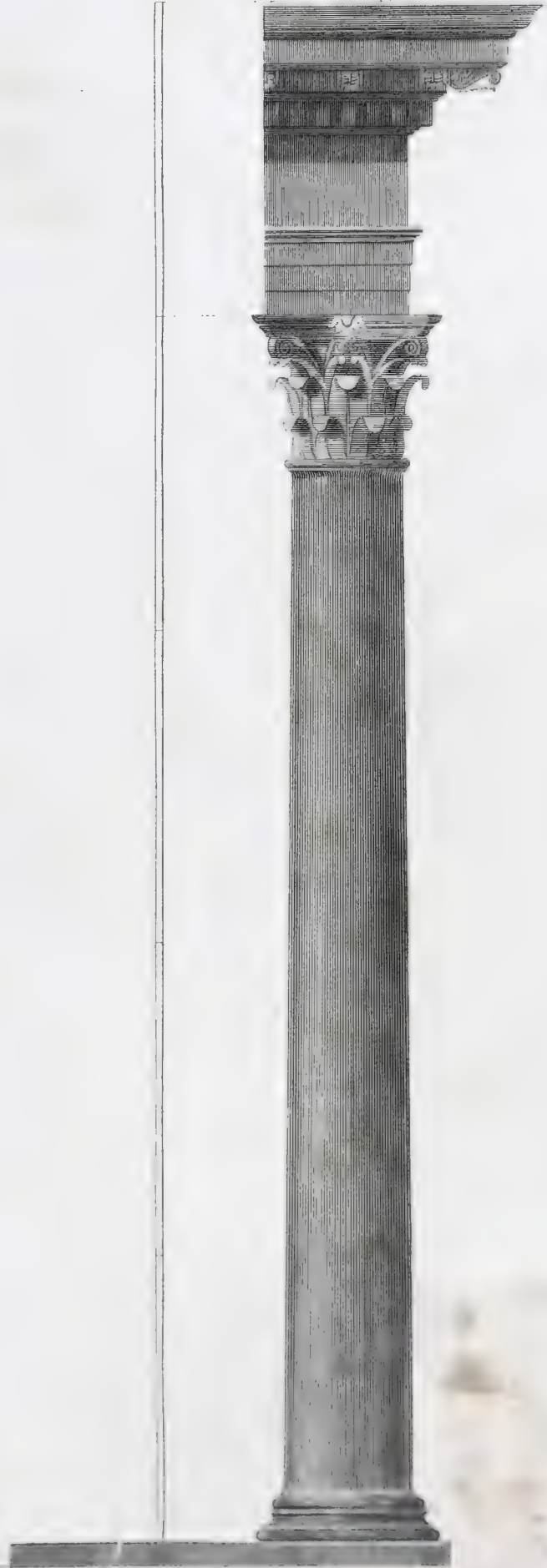
Fig. 1







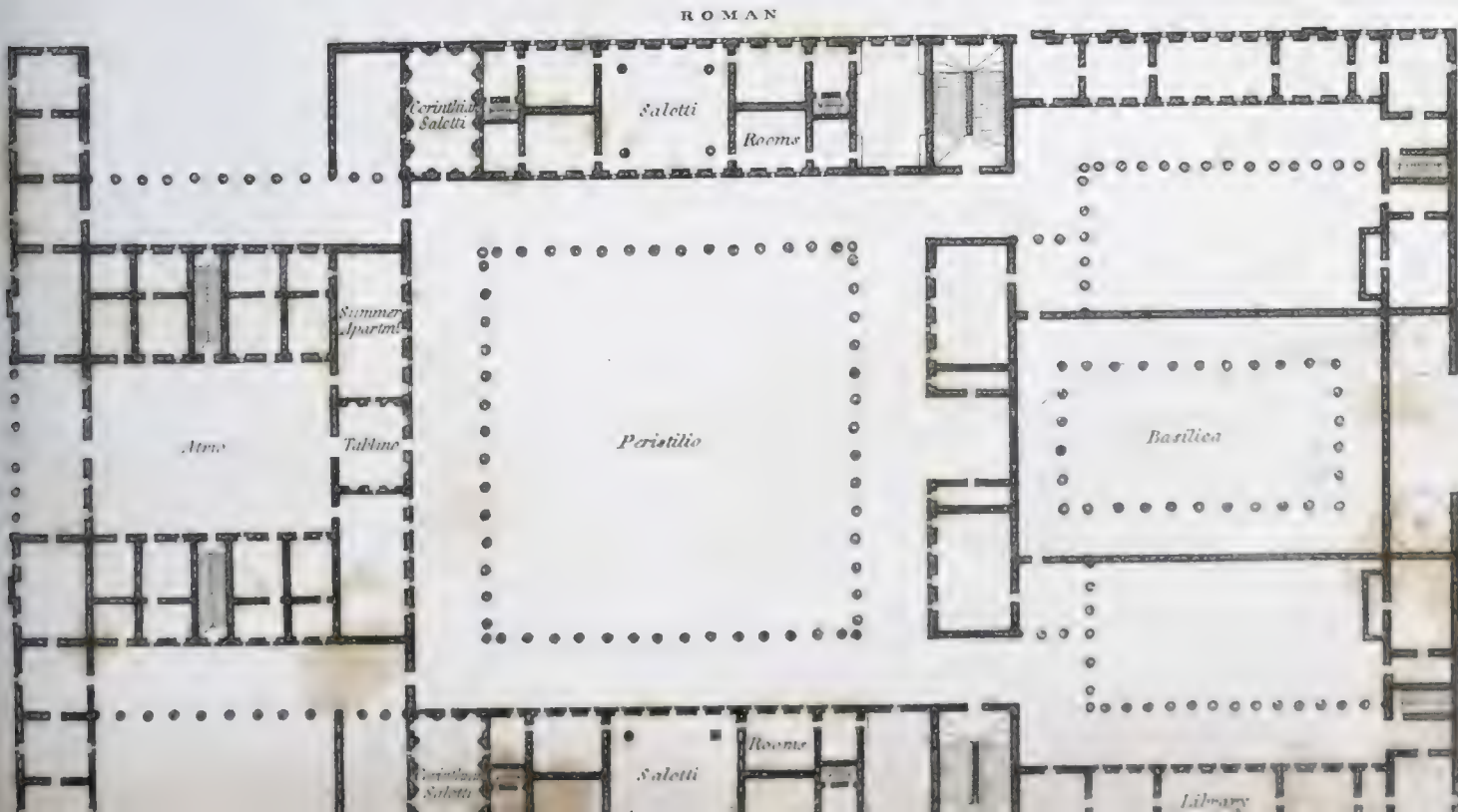
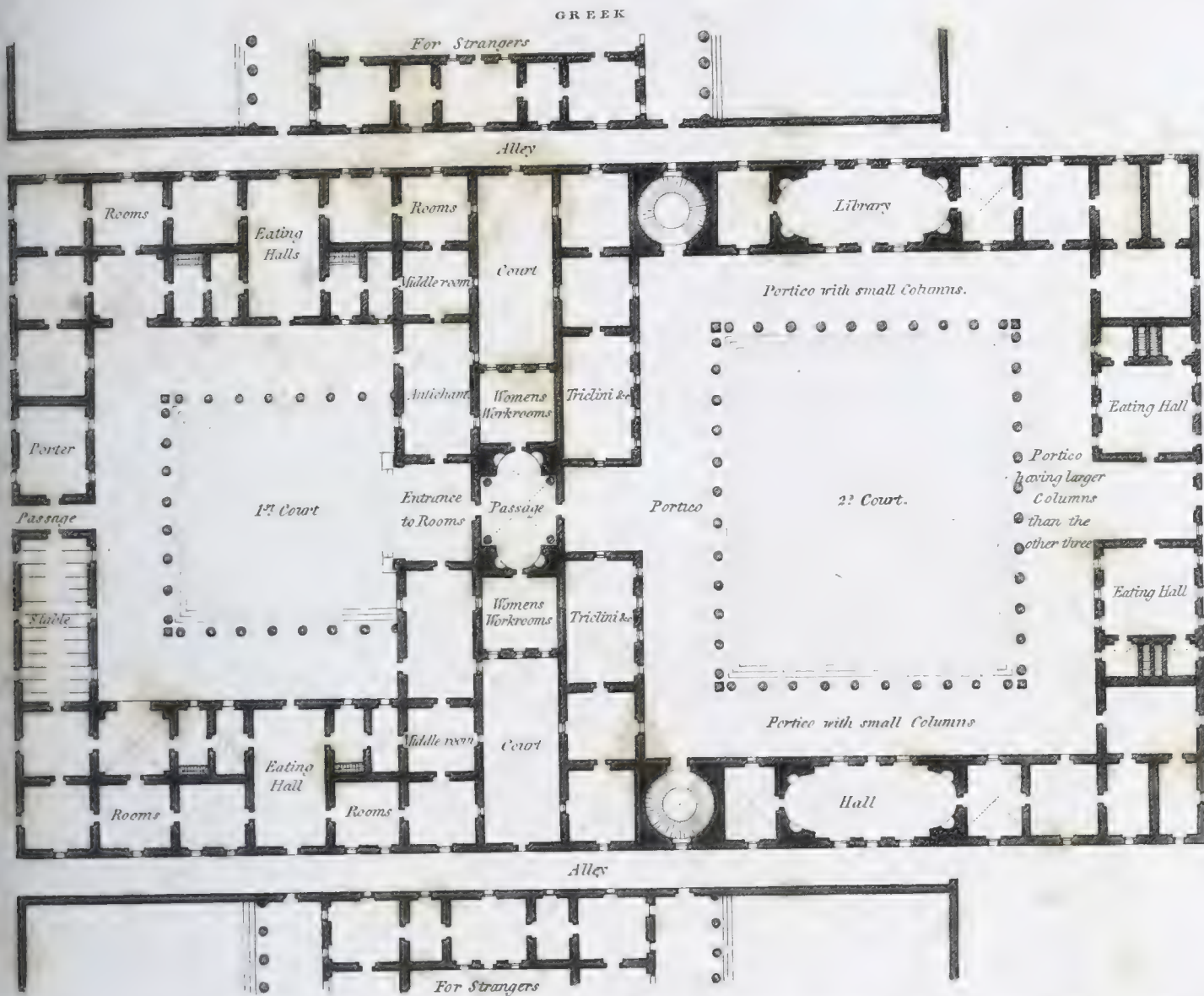
*Corinthian Order.*





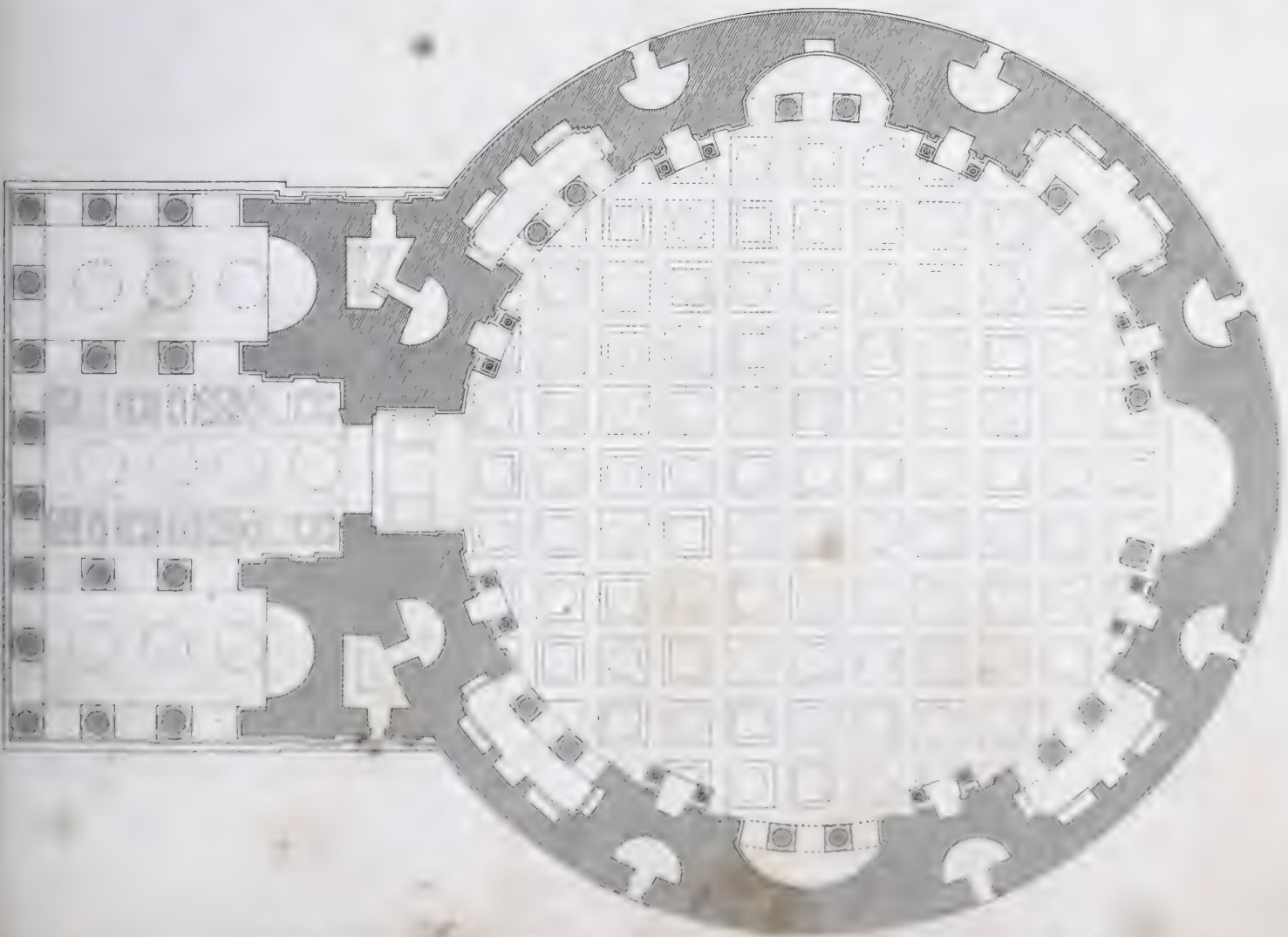
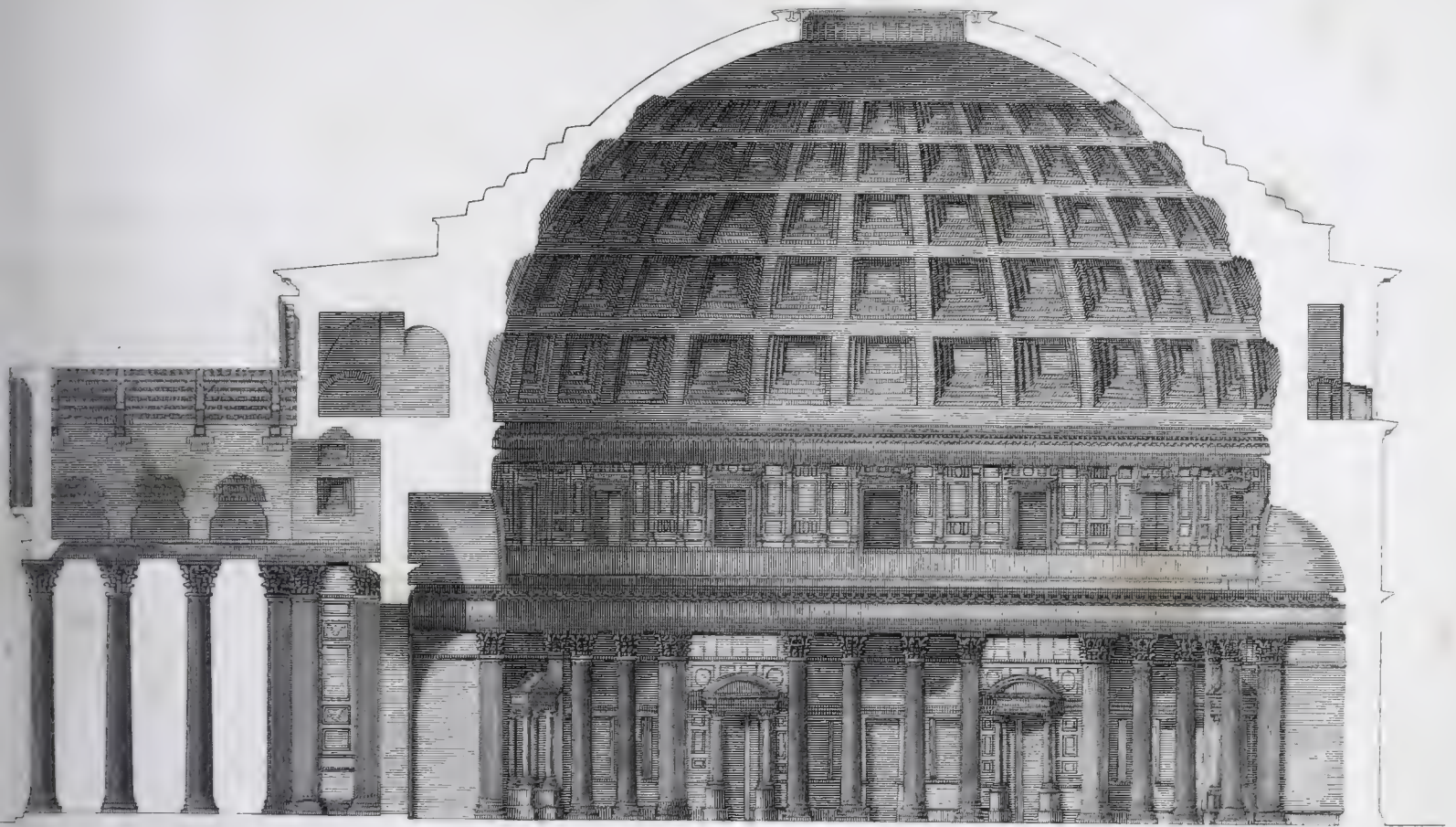
# CIVIL ARCHITECTURE.

PLANS Shewing the Disposition of the Apartments in GREEK and ROMAN Villas.





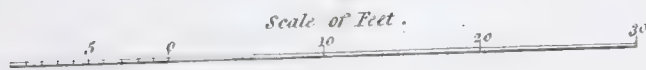
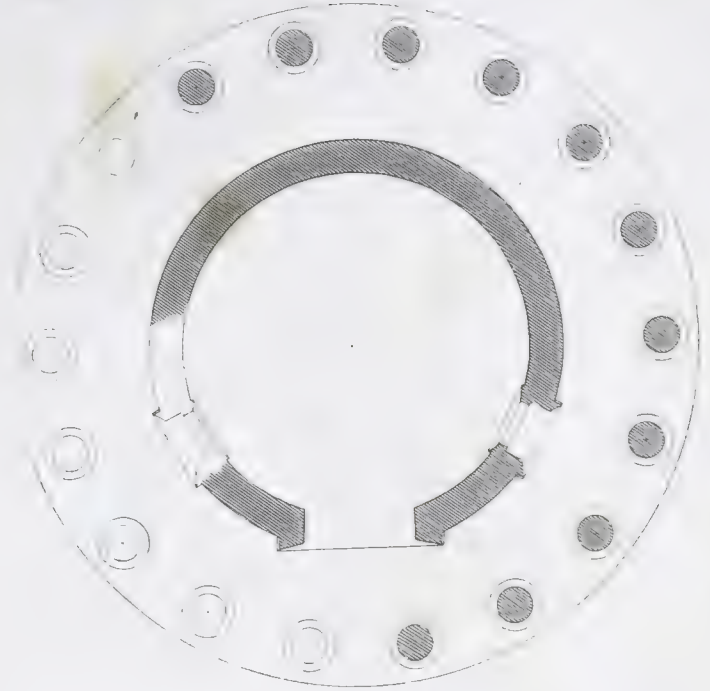
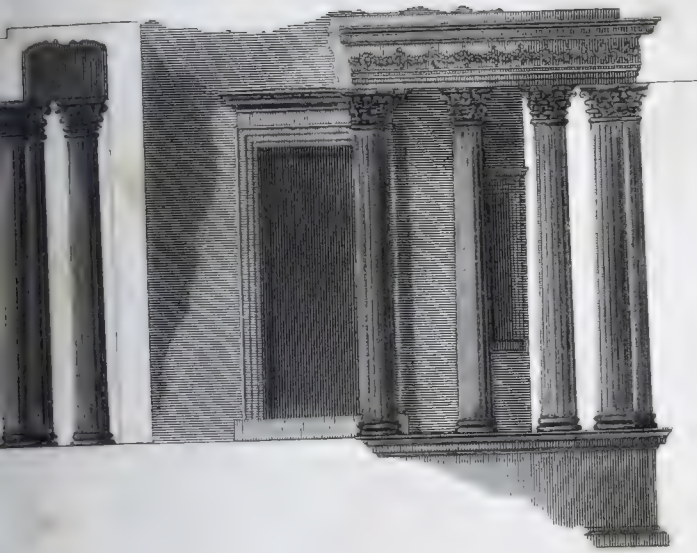
THE PANTHEON AT ROME.



0 10 20 30 40 50



ELEVATION and PLAN of the TEMPLE of VESTA at TIVOLI.



SECTION of the TEMPLE of FAVUS at ROME.



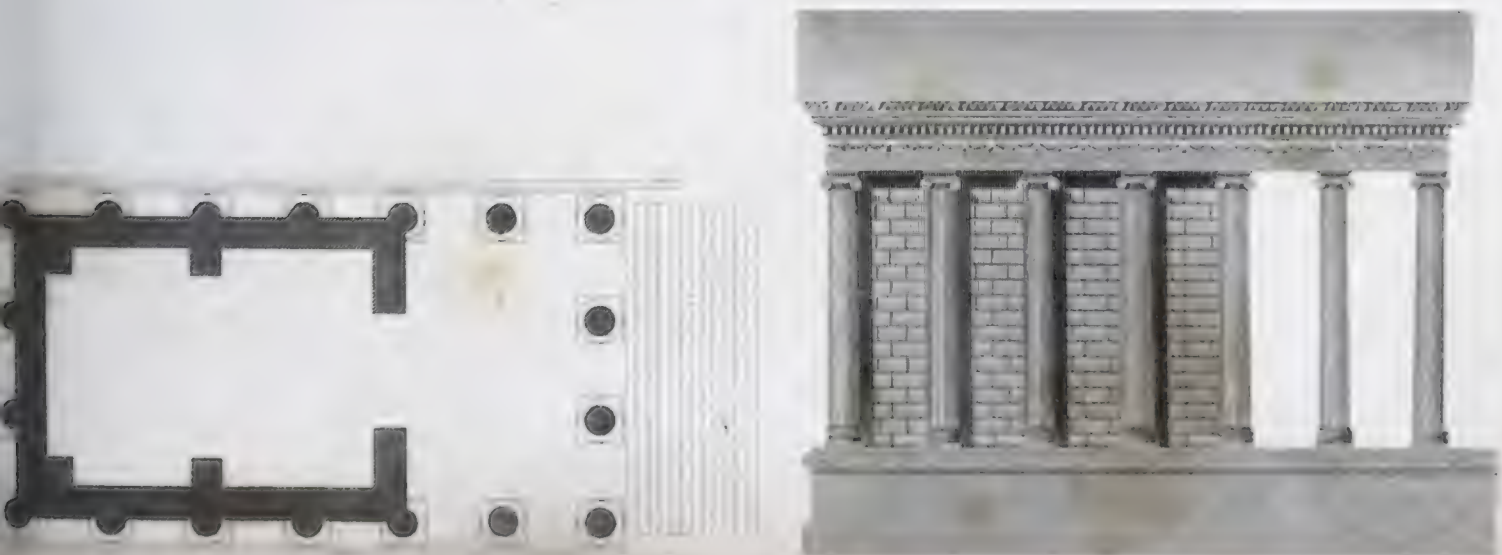




SECTION AND PLAN OF THE REMAINS OF THE TEMPLE OF PEACE AT ROME

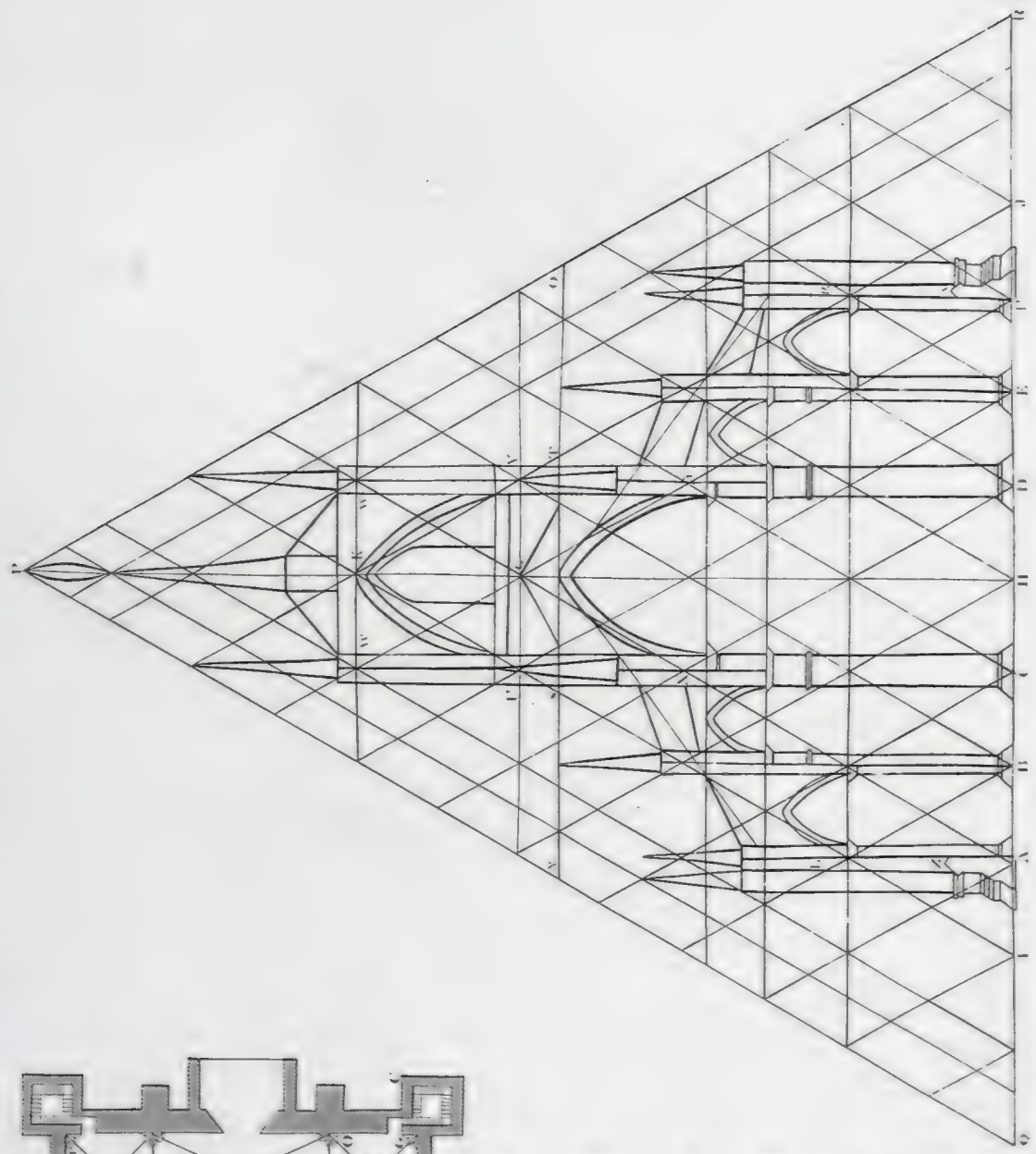
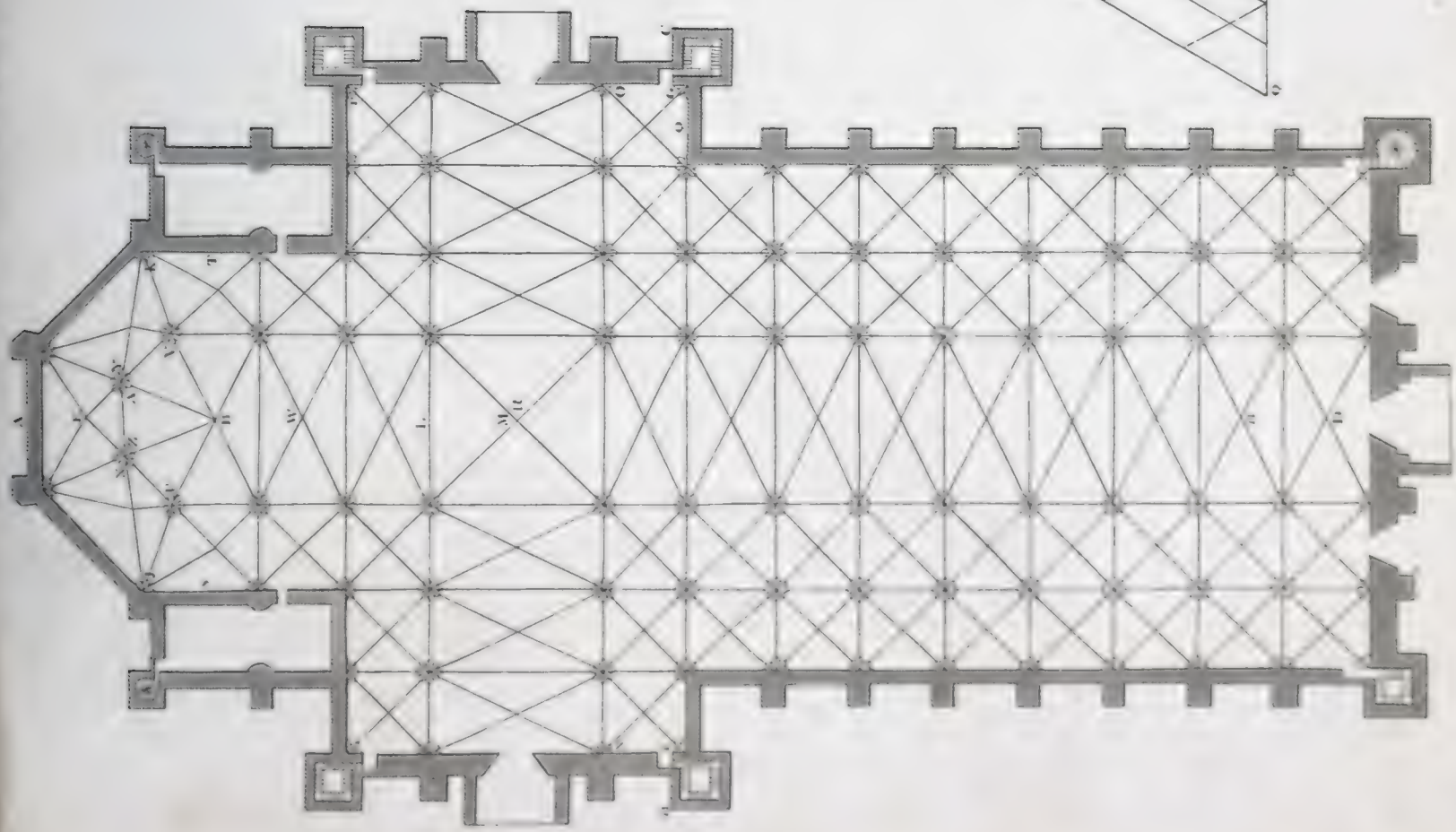


PLAN AND SIDE ELEVATION OF THE TEMPLE OF FORTUNA VIRILIS AT ROME.





MILAN CATHEDRAL. Theory of its Construction



Scale of Milanese Cubits



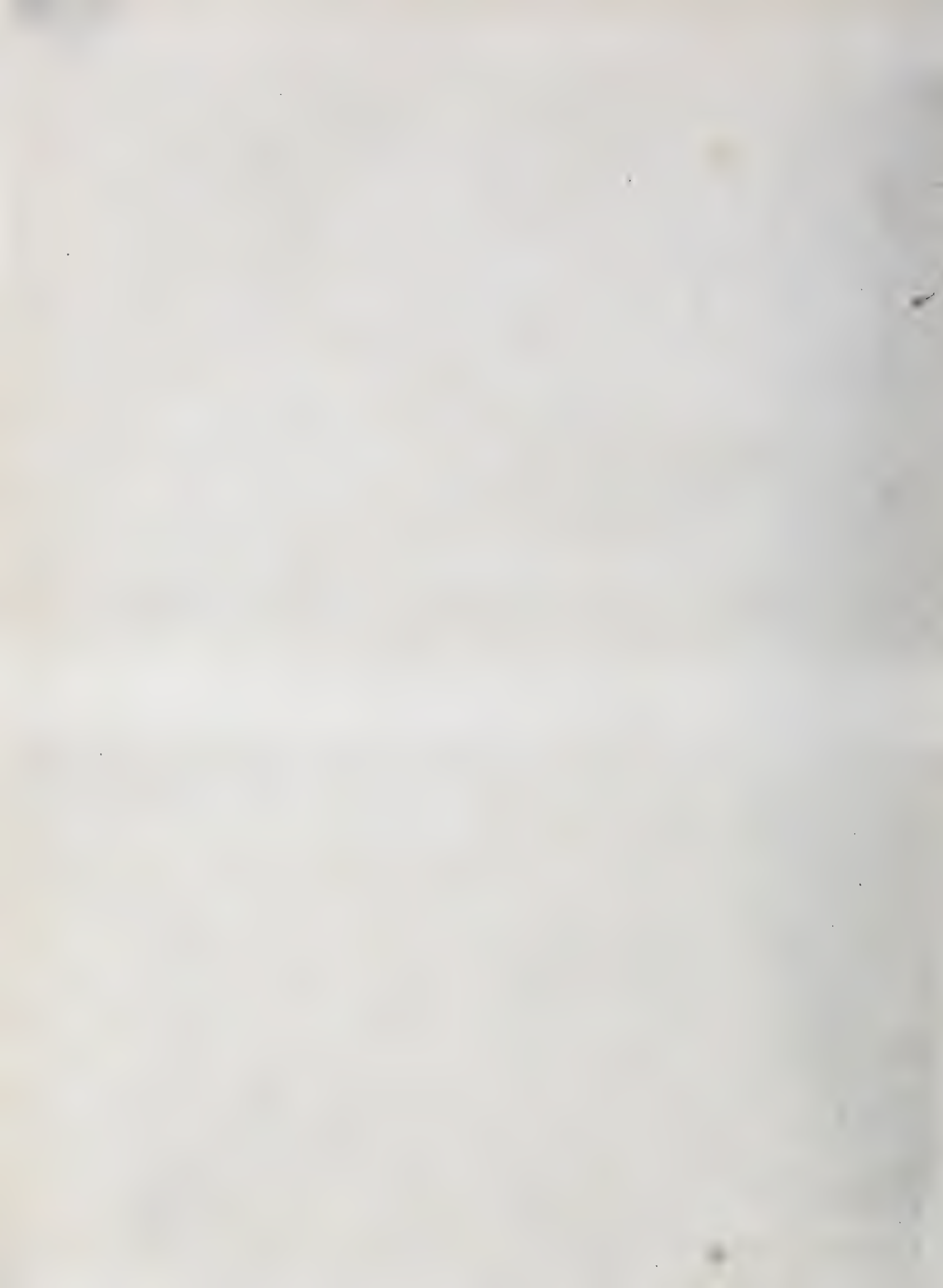
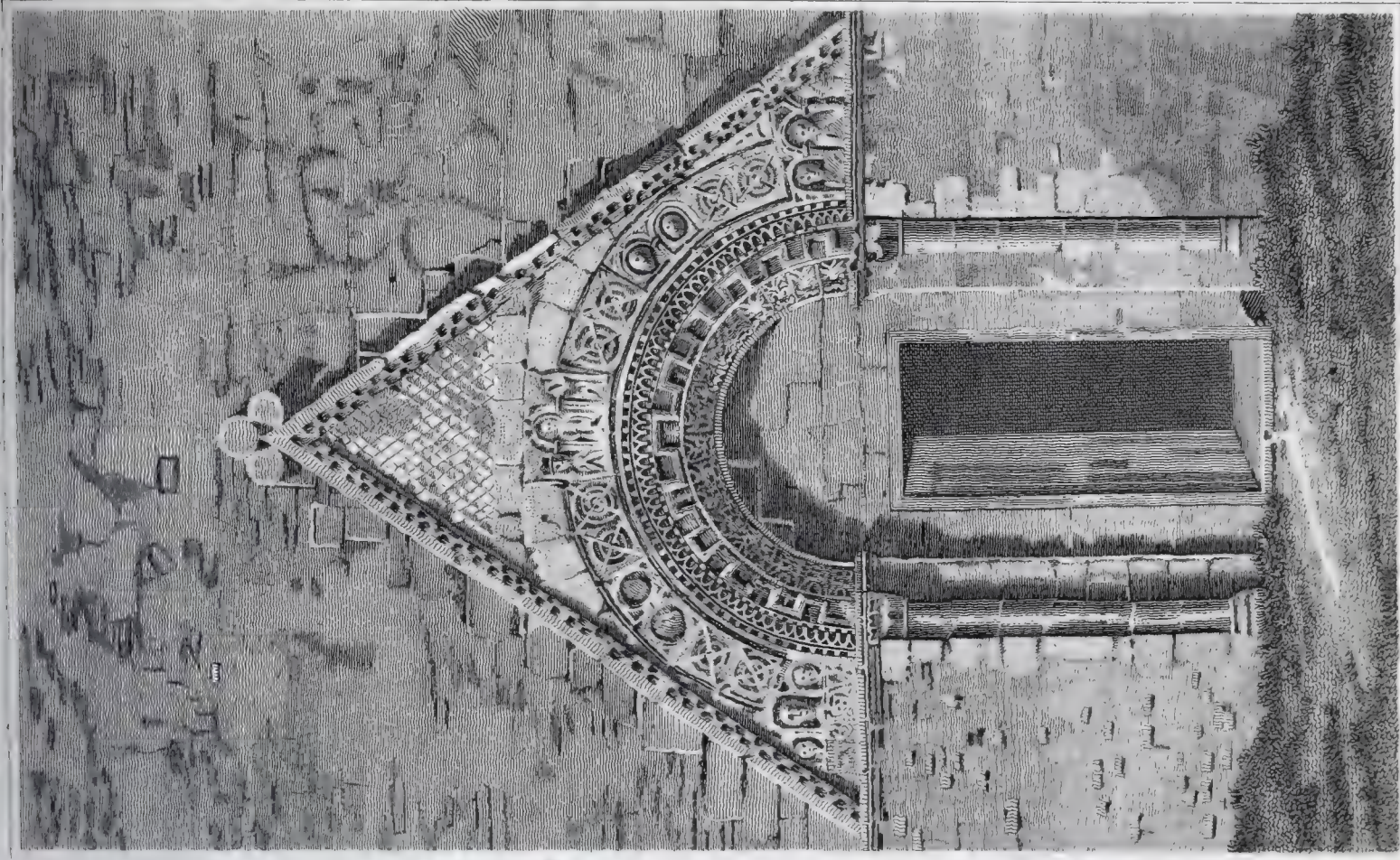


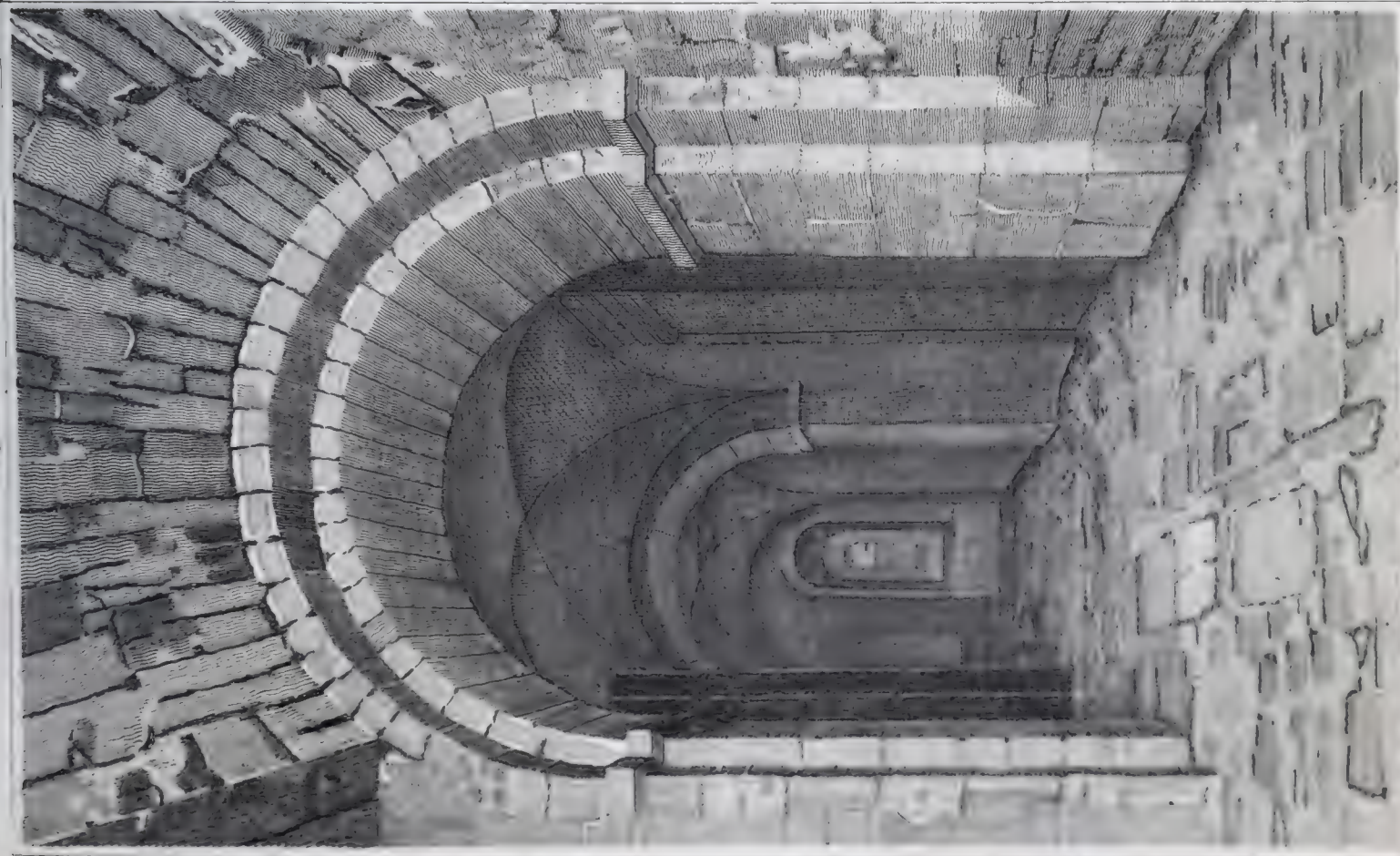
Fig. 2.



WEST DOOR of the CHURCH of CLIEF near DOVER.

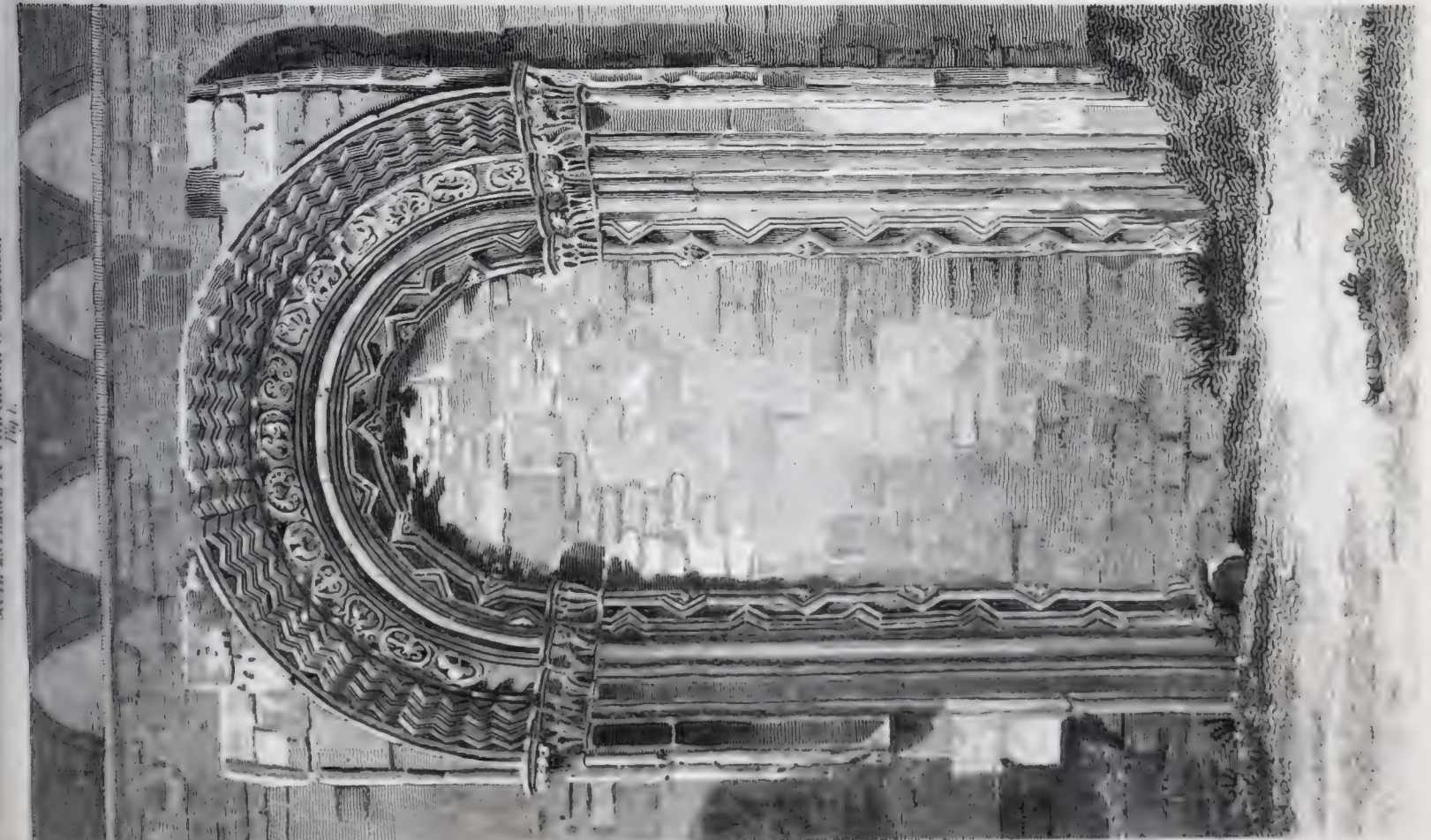
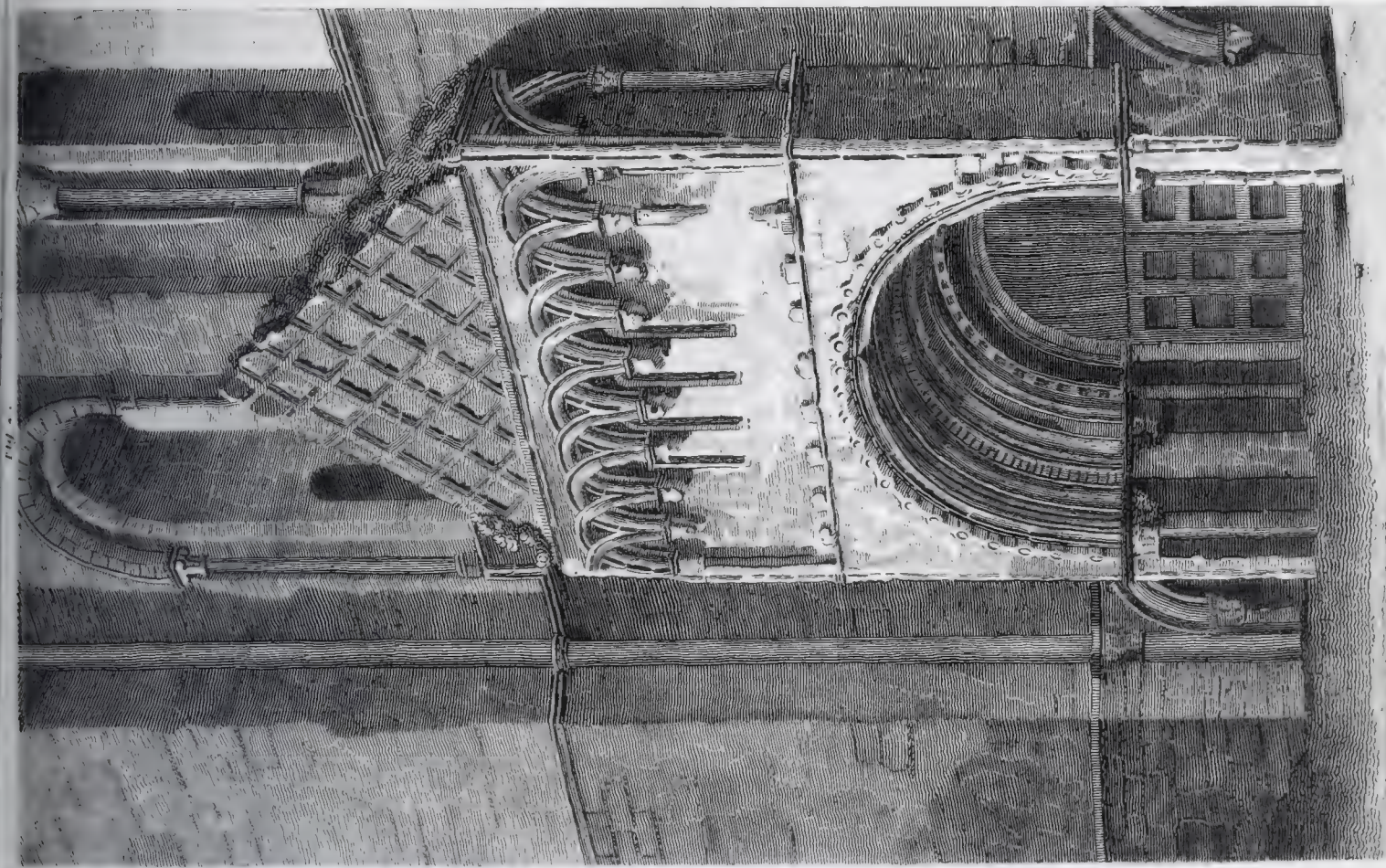
M. Kippenh. sc.

Fig. 1.



DOORWAY at MONASTERY in the ISLE of THANET.





SOUTH ENTRANCE TO THIS CATHEDRAL OF SARRASSEN.

Fig. 1.





Fig. 1.  
ARCHES from the TREASURY at CANTERBURY



Fig. 2.  
ARCH from the TOWER of ST. AUGUSTINES MONASTRY CANTERBURY

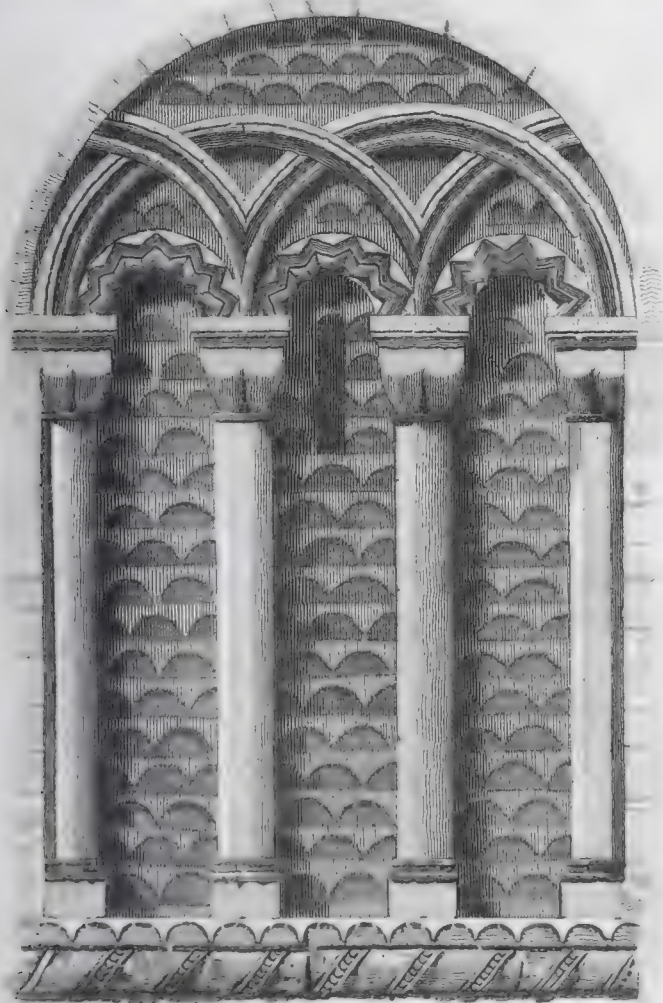


Fig. 3.  
CATHERINE WHEEL WINDOW from End of BARFRESTON CHURCH KENT.



Fig. 4.

Fig. 5.

Fig. 6.

Fig. 7.



ORNAMENTED COLUMNS from ST. AUGUSTINES MONASTERY

NORMAN CAPITALS from CANTERBURY CATHEDRAL.

Fig. 8.

Fig. 9.

Fig. 10.



Fig. 11.



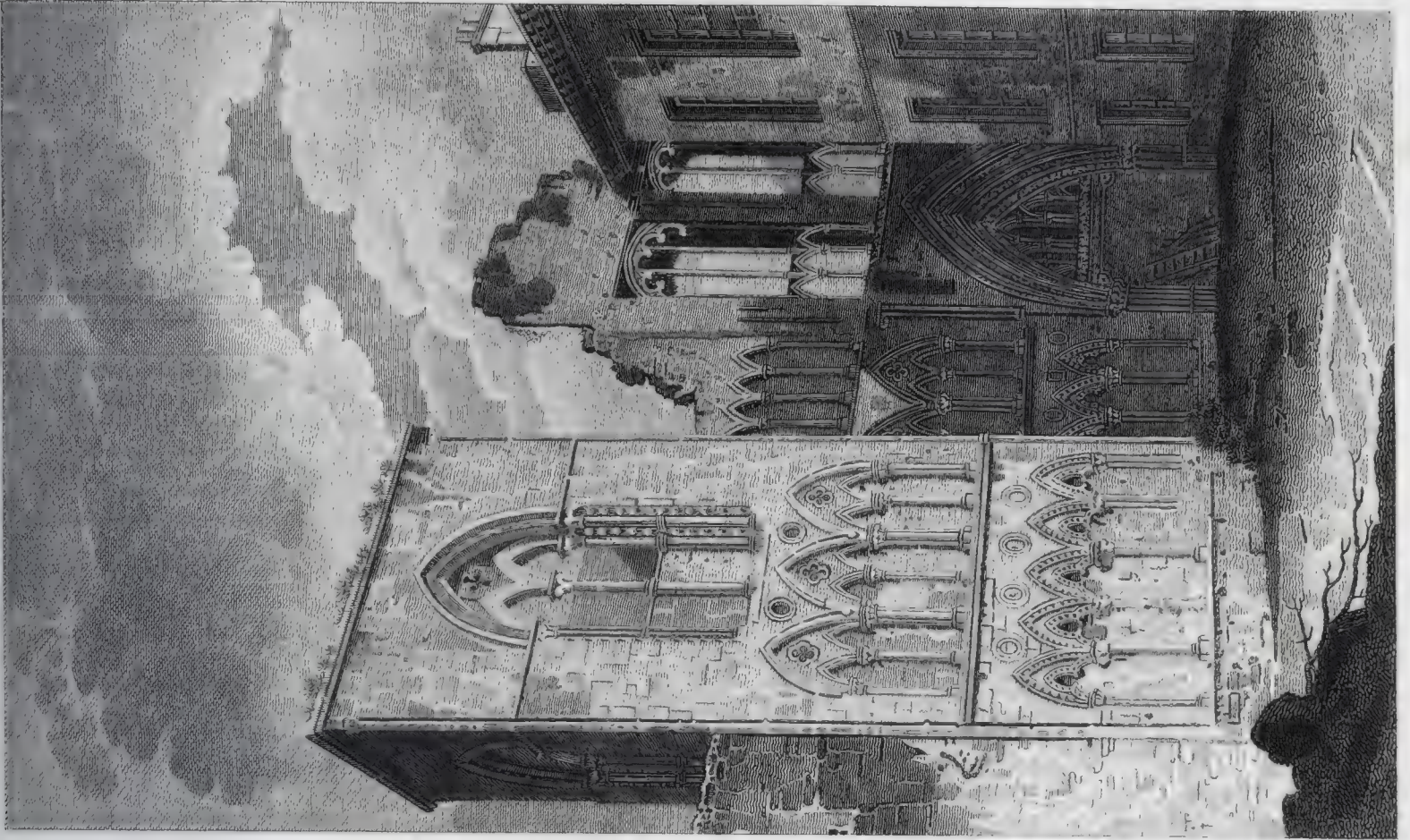
BORDERS from BARFRESTON CHURCH KENT.

Fig. 12.

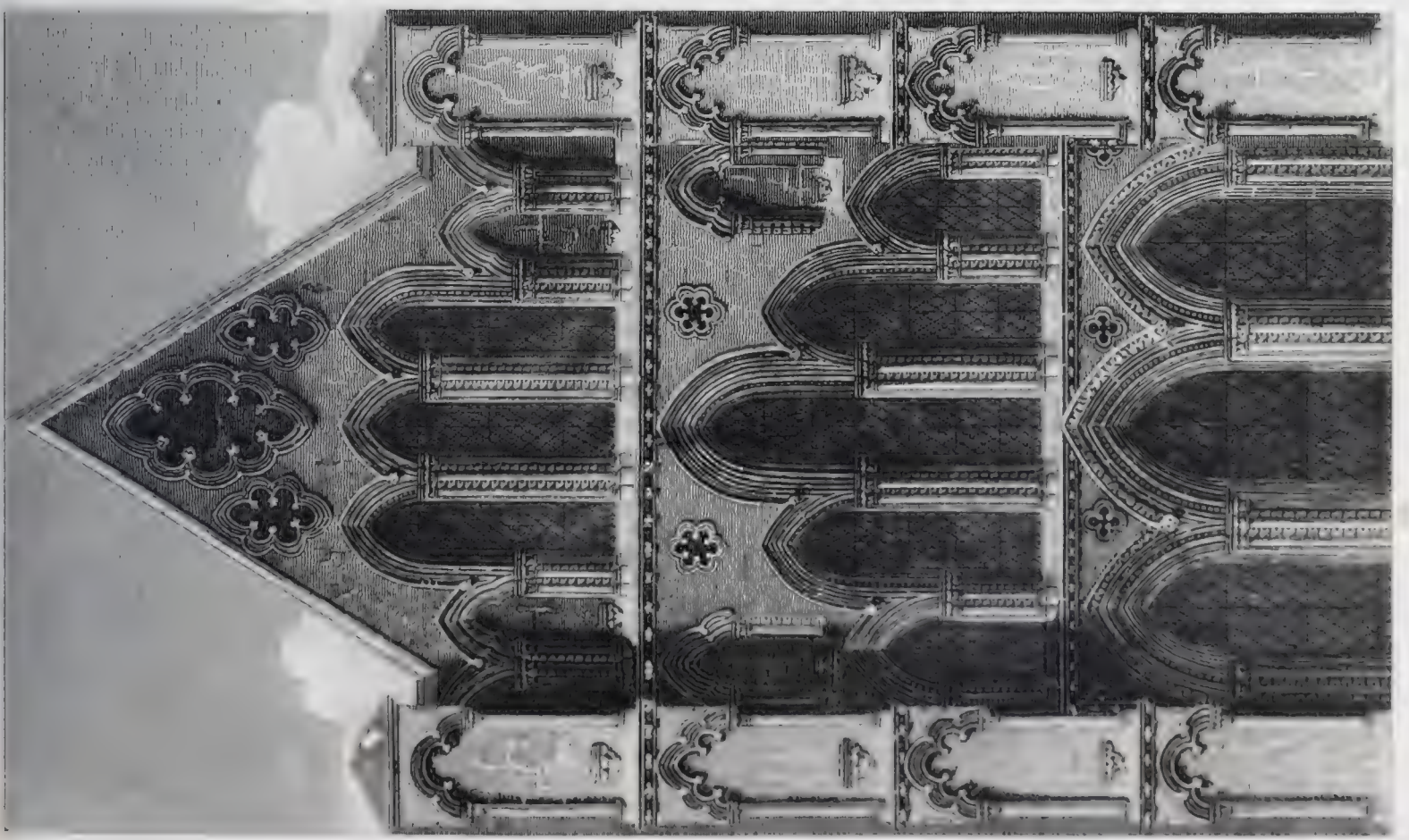




WEST END OF HOLYROOD CHAPEL

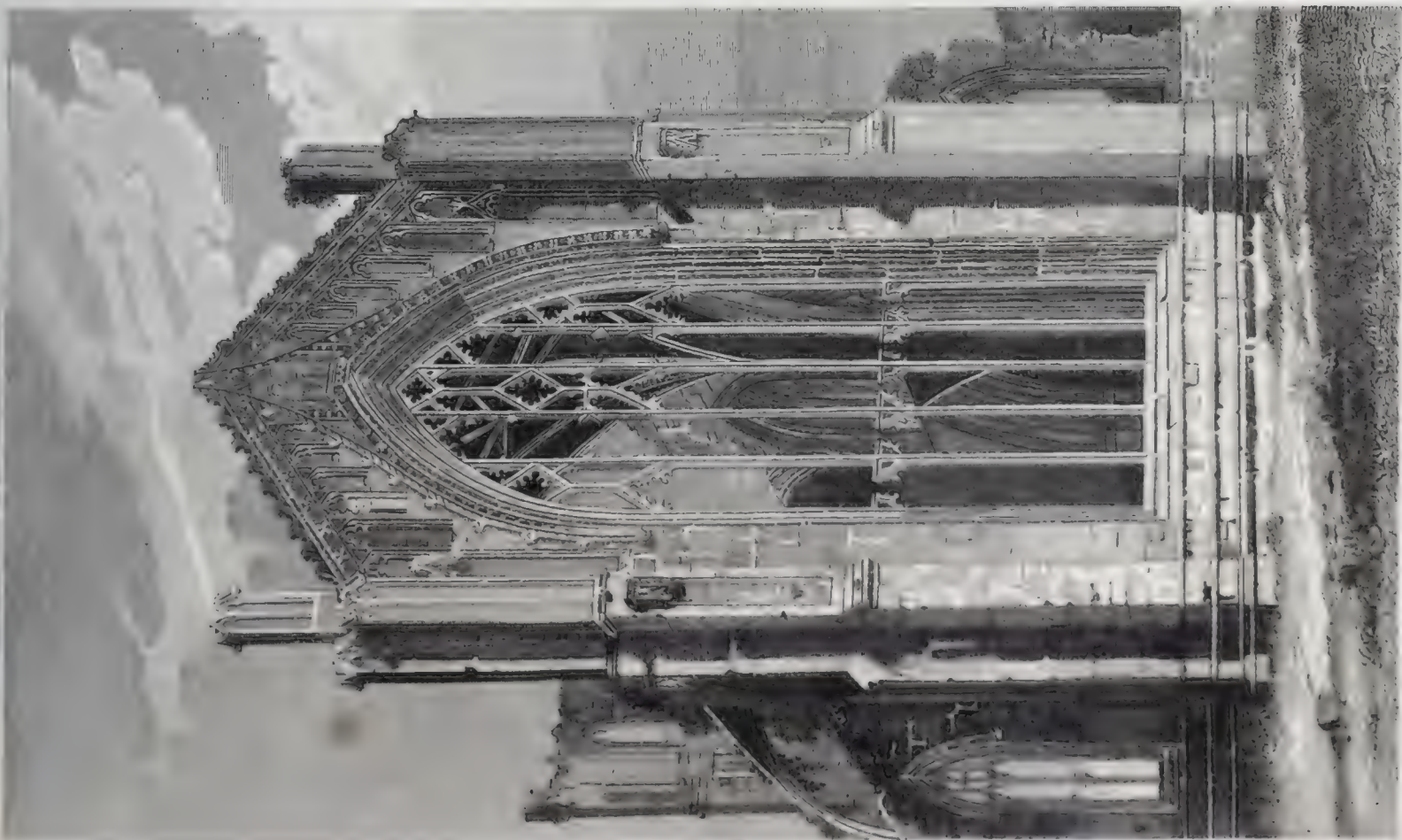


EAST END OF ELY CATHEDRAL

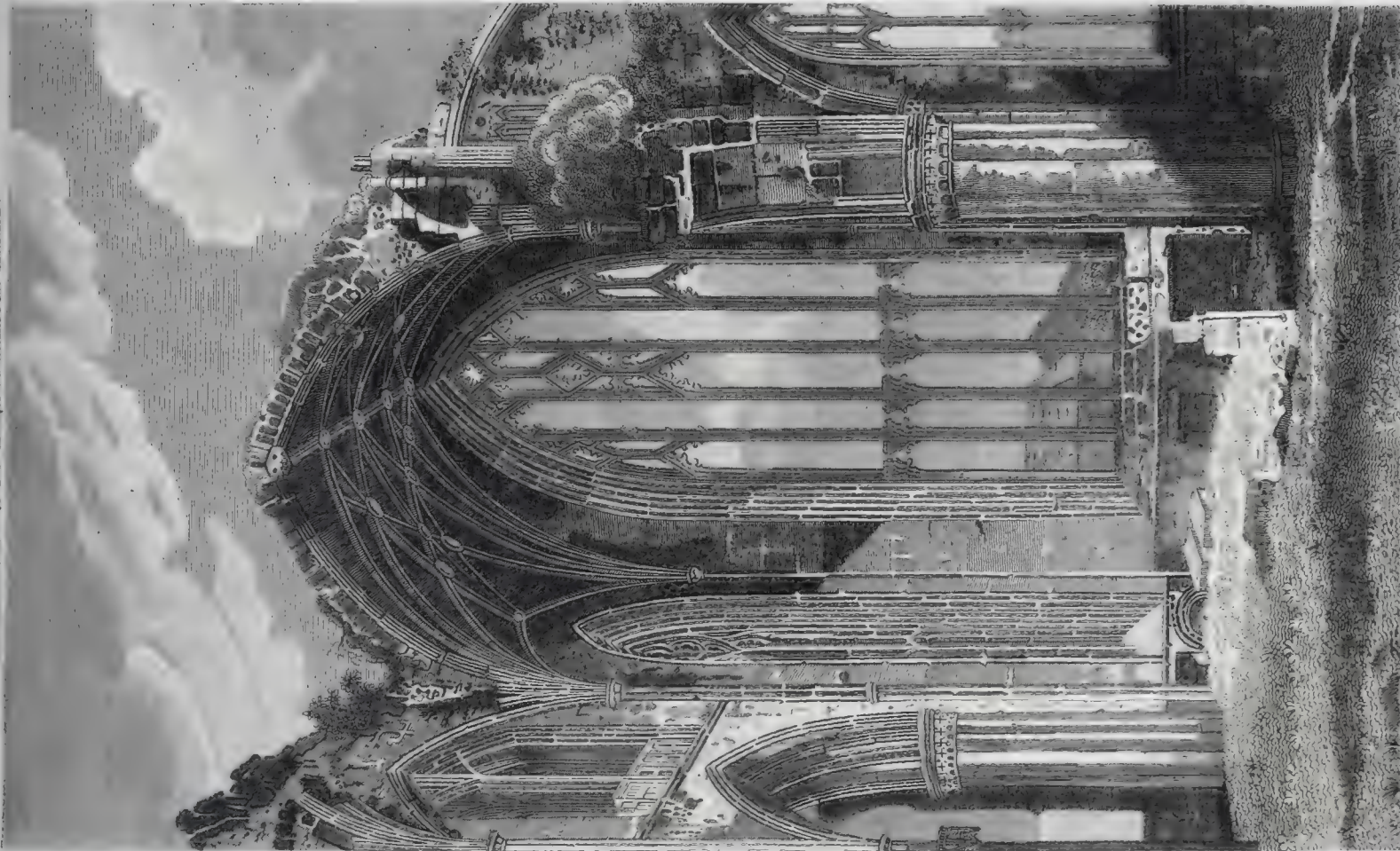




EXTERIOR VIEW of the CHOR of MELROSE ABBEY.

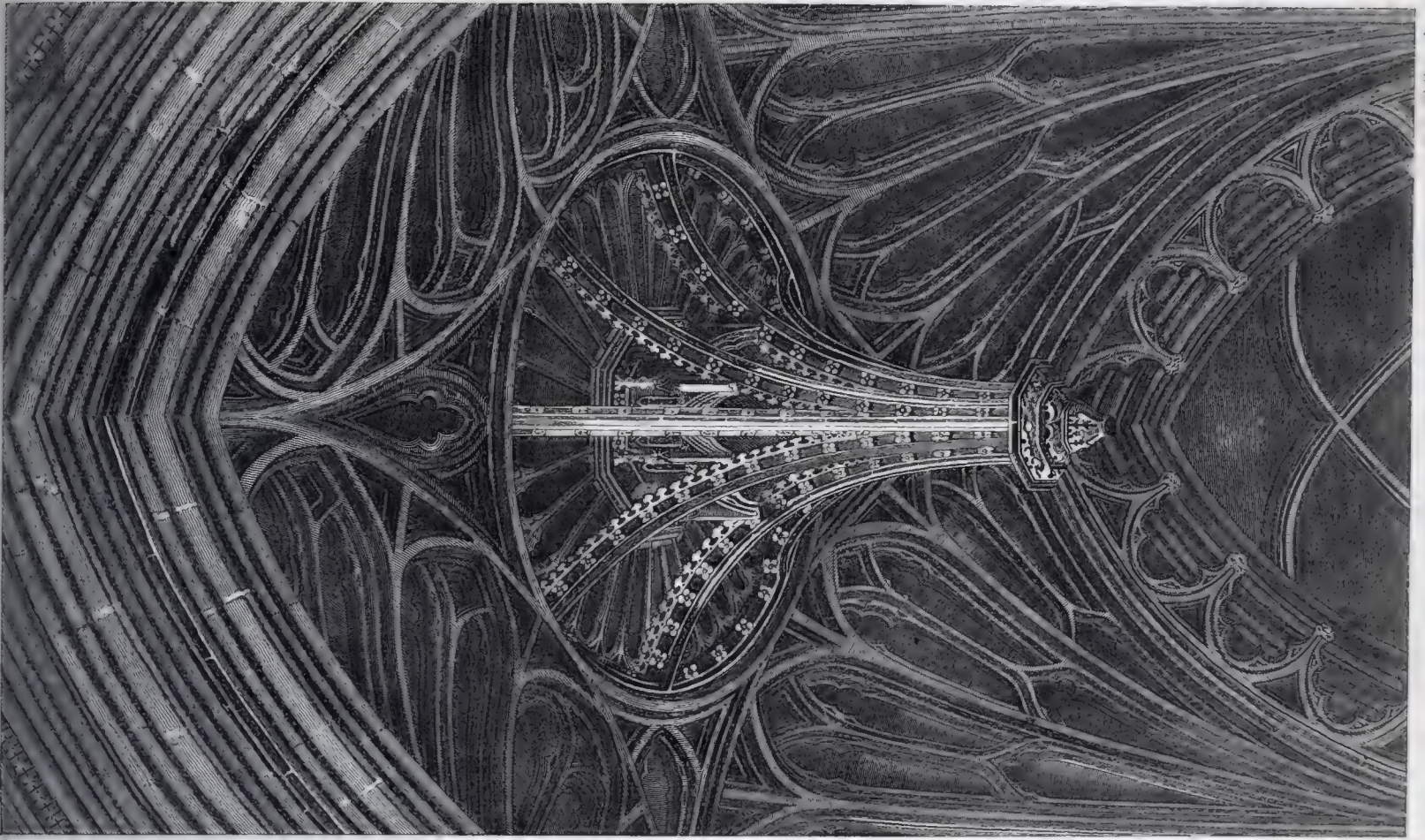


INTERIOR VIEW of the CHOR of MELROSE ABBEY.





PENDANT FROM THE ROOF OF BISHOP ALCOCK'S CHAPEL, ELY CATHEDRAL.



VIEW OF THE TOWER OF BISHOP ALCOCK'S CHAPEL, ELY CATHEDRAL.

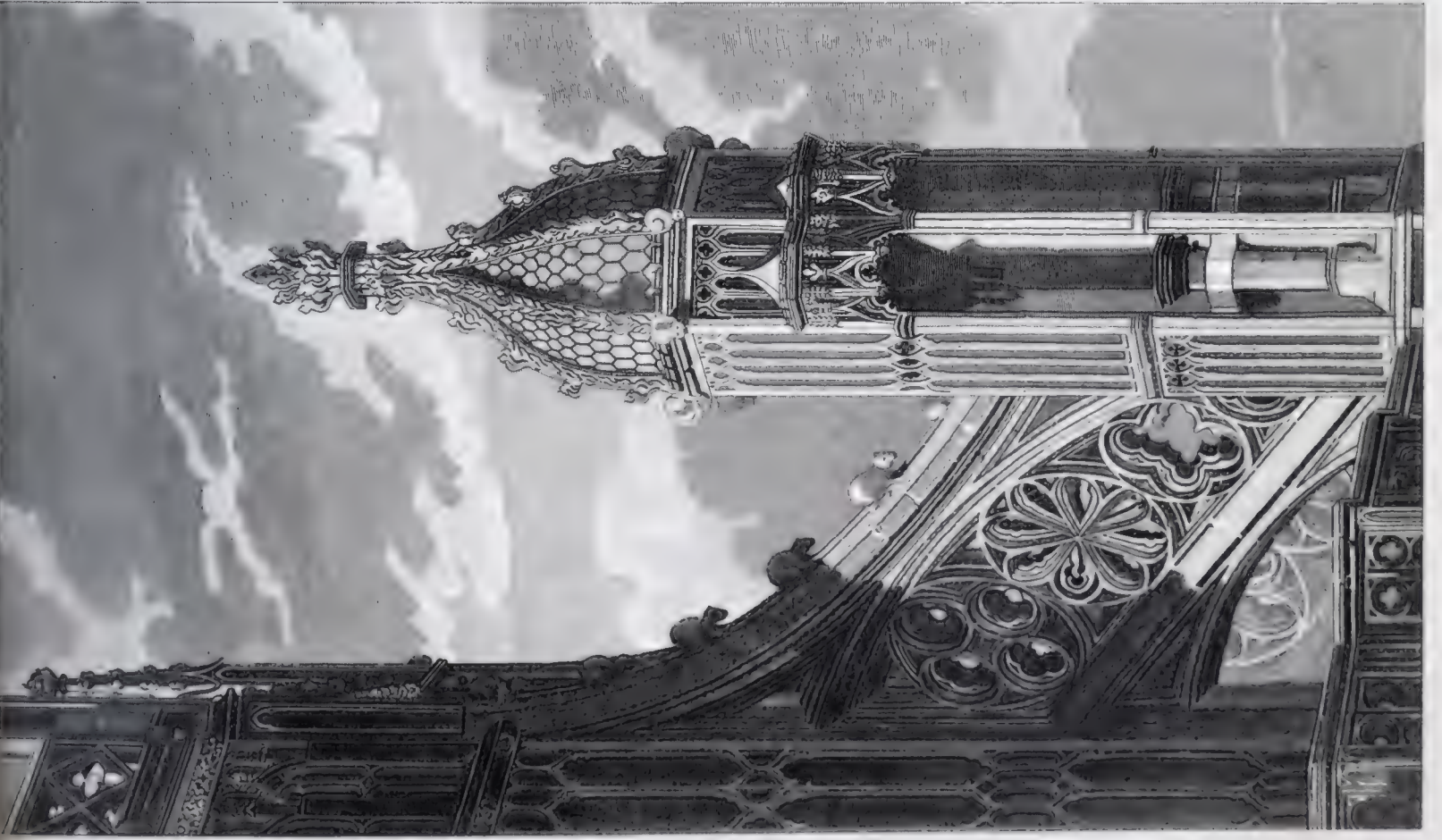






Fig. 1



Fig. 2

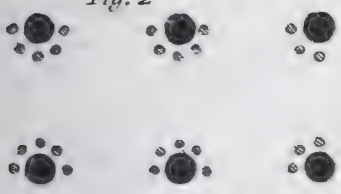


Fig. 3



Fig. 8



Fig. 9

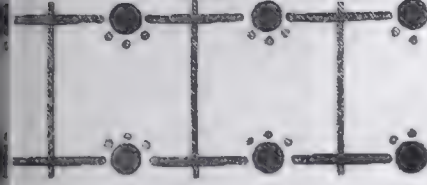


Fig. 10



Fig. 4

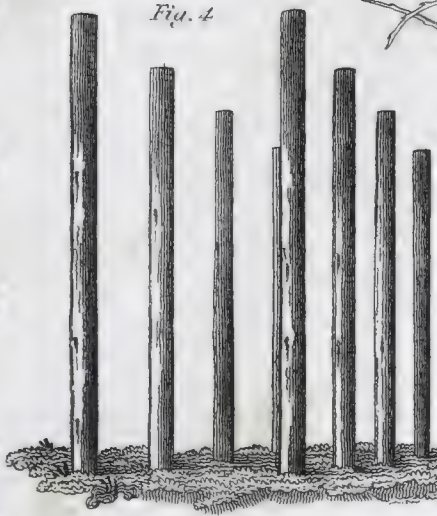


Fig. 5

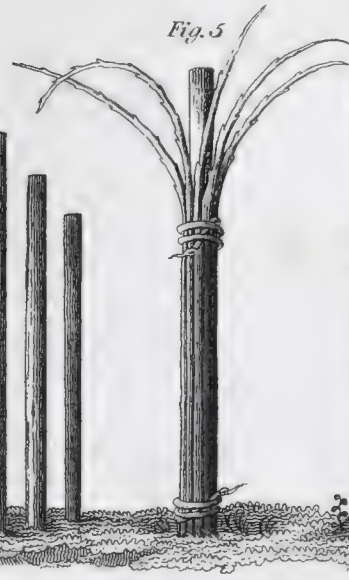


Fig. 6

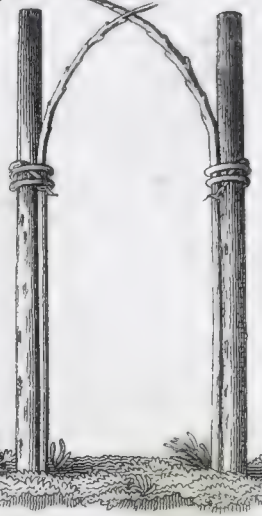


Fig. 7



Fig. 11

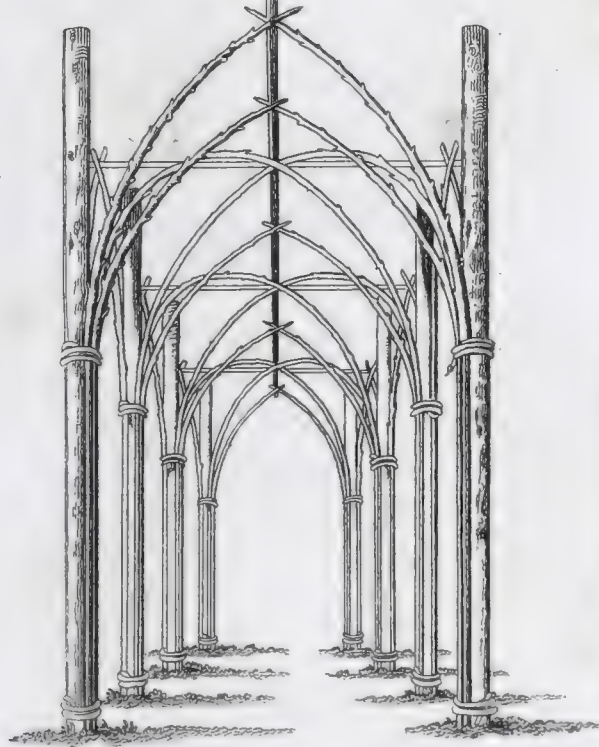


Fig. 12

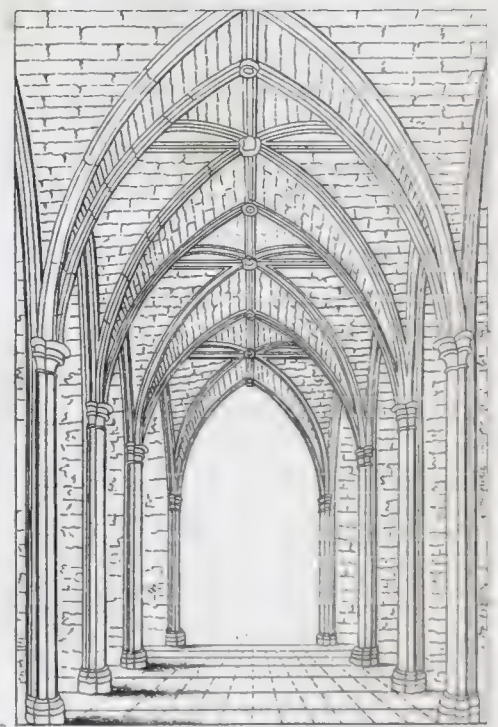


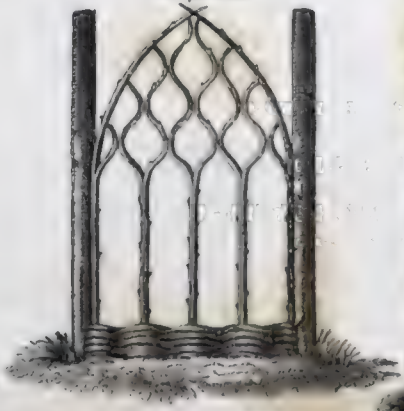
Fig. 15

Fig. 16

Fig. 13

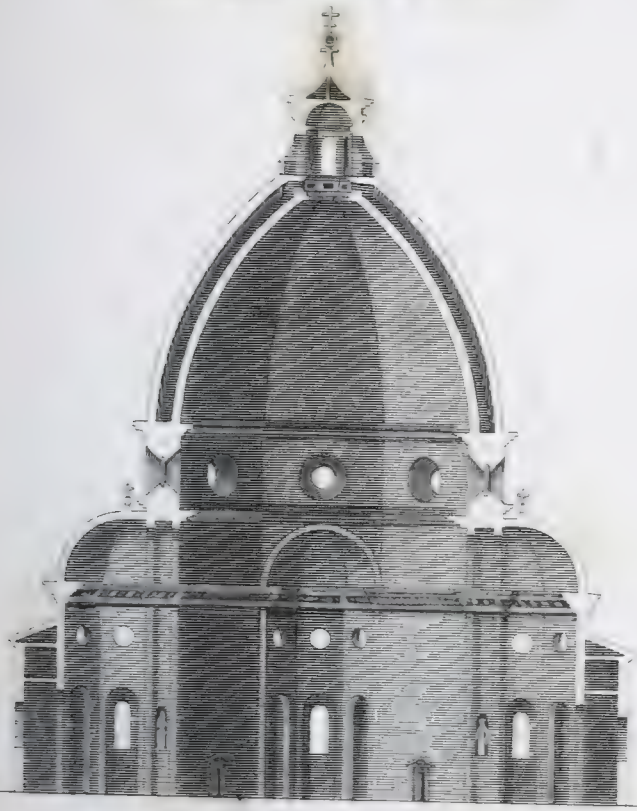


Fig. 14

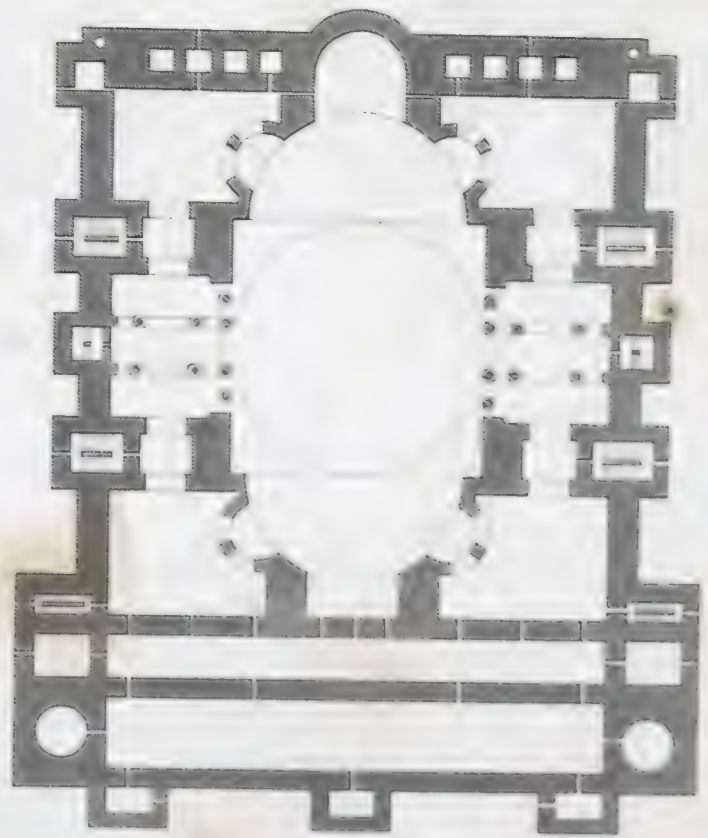
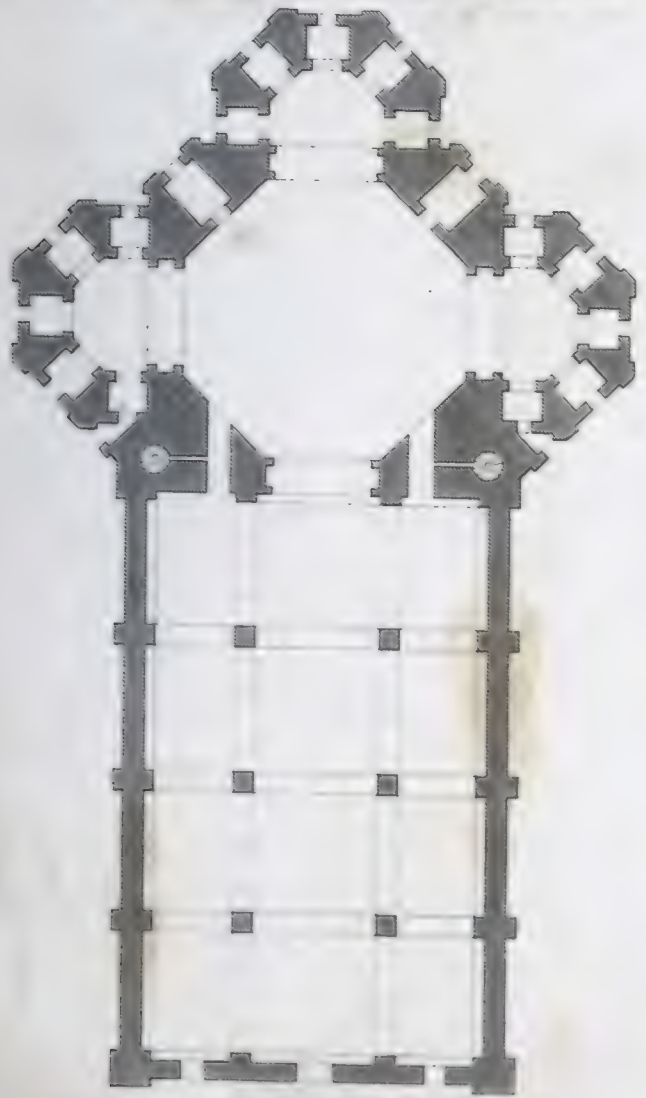
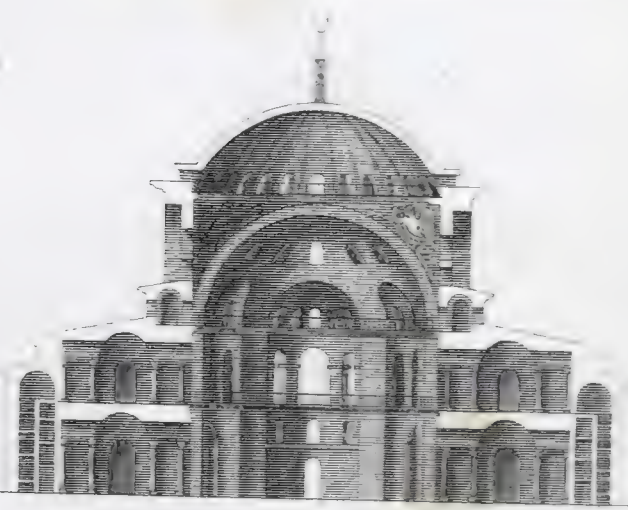




*SAINTE MARYS CHURCH AT FLORENCE.*



*SAINTE SOPHIE CHURCH AT CONSTANTINOPLE.*



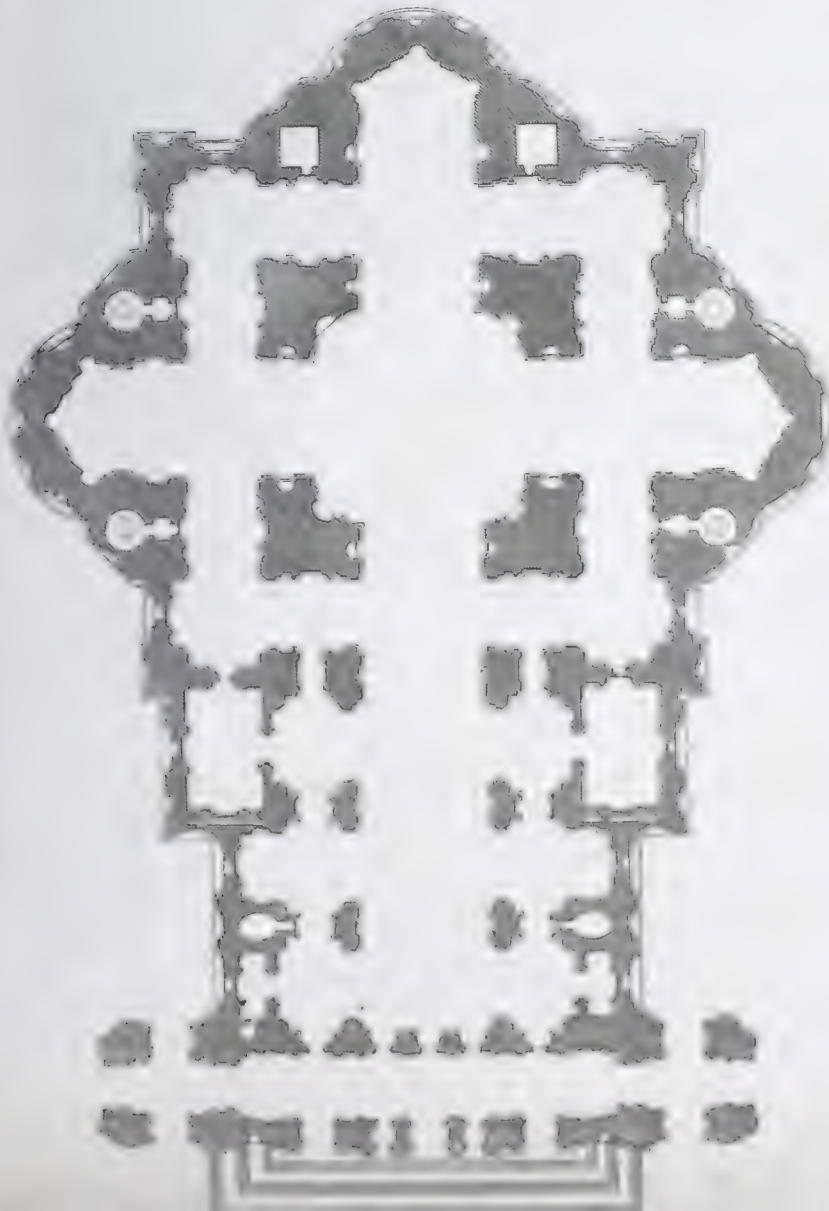




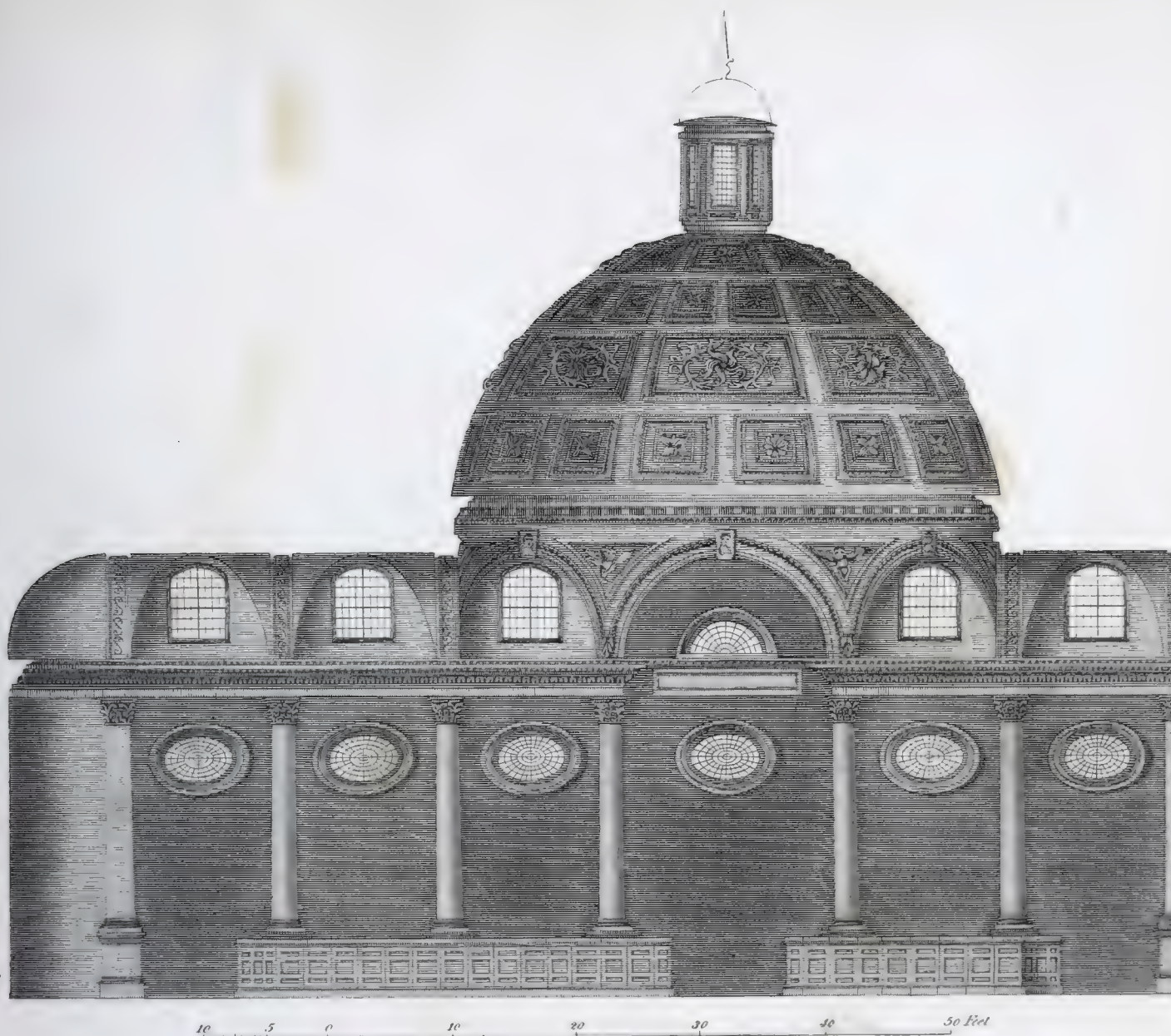
*St. Peter's Church in Rome.*



*St. Paul's Church in London.*







10 5 0 10 20 30 40 50 Feet

CHURCH of ST. STEPHEN WALBROOK in LONDON.

Fig 1

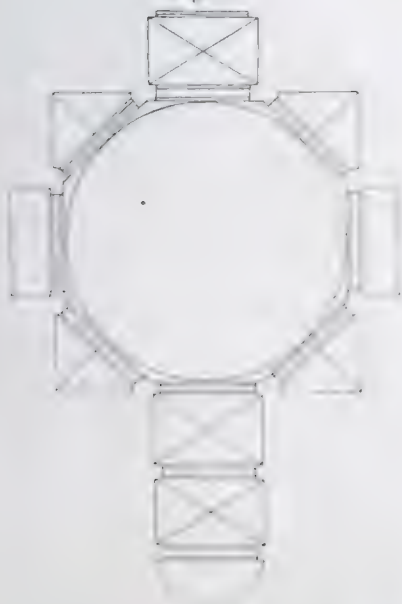
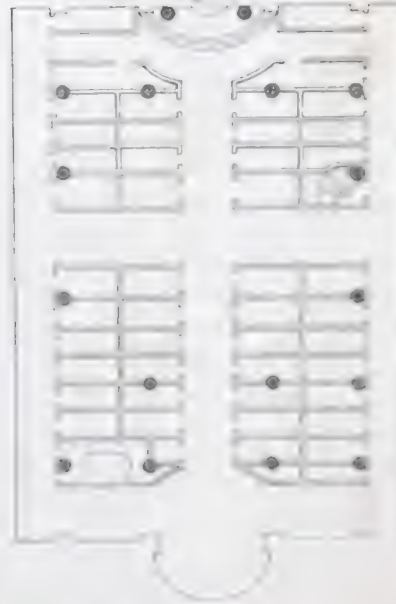


Fig 2



Fig 3

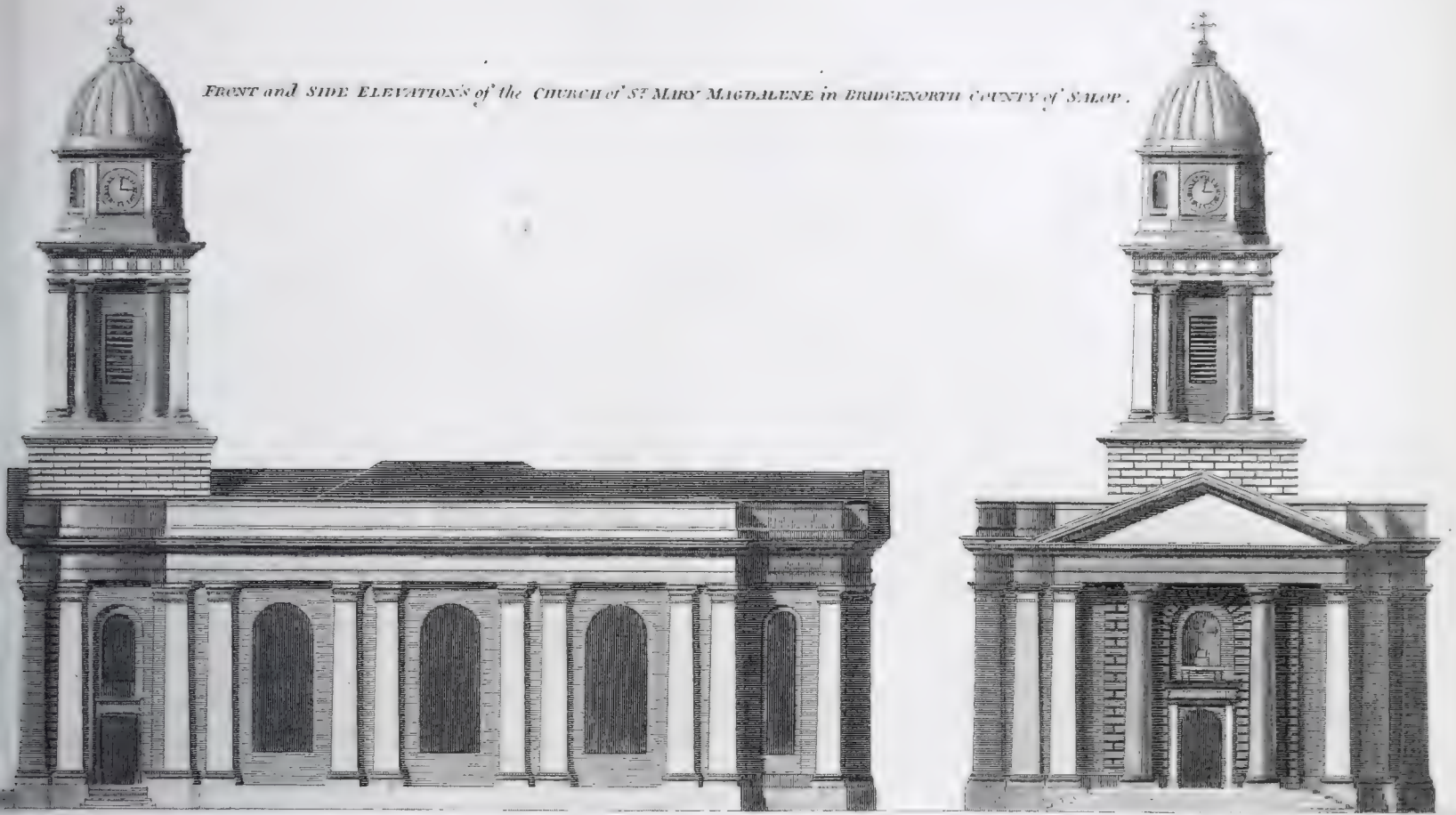


10 0 10 20 30 40 50 60 70 80 Feet



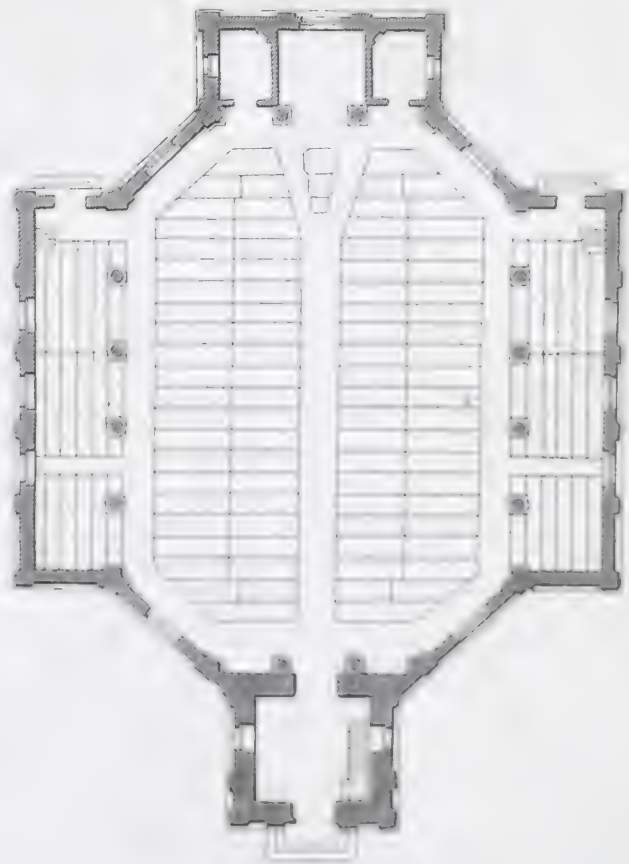
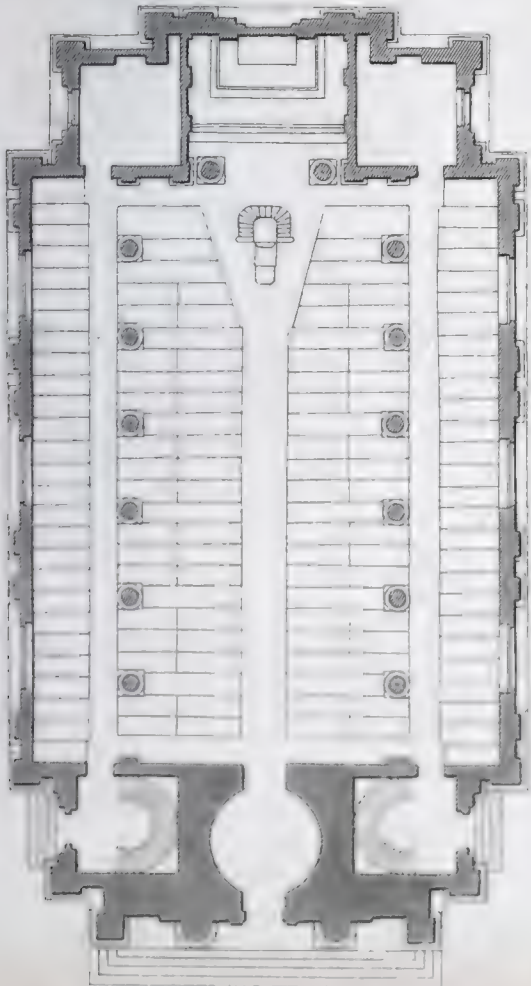


FRONT and SIDE ELEVATIONS of the CHURCH of ST MARY MAGDALENE in BRIDGENORTH COUNTY of SALOP.



PLAN of BRIDGENORTH CHURCH.

PLAN of a CHURCH at MIDELEY COUNTY of SALOP.

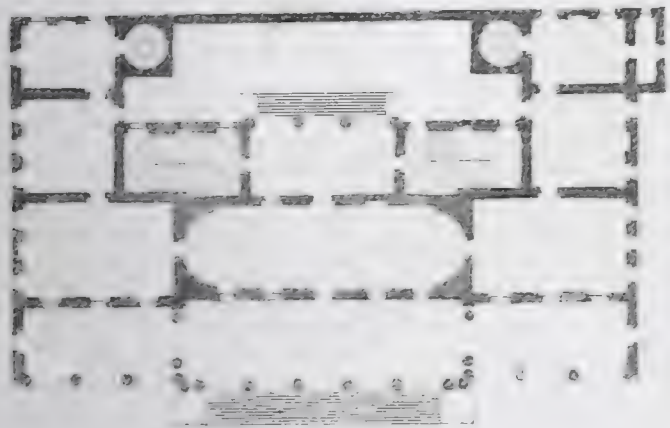
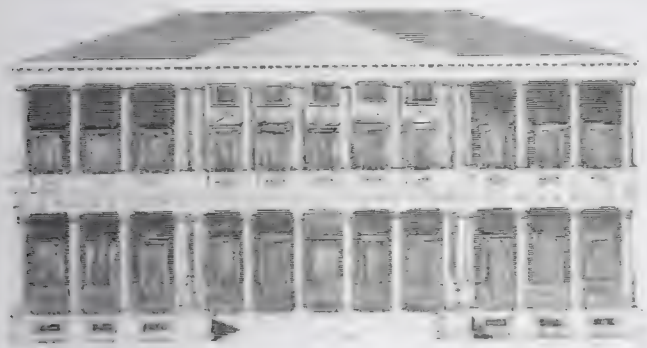


20 0 10 20 30 40 50 60 70 80 90 100 feet.

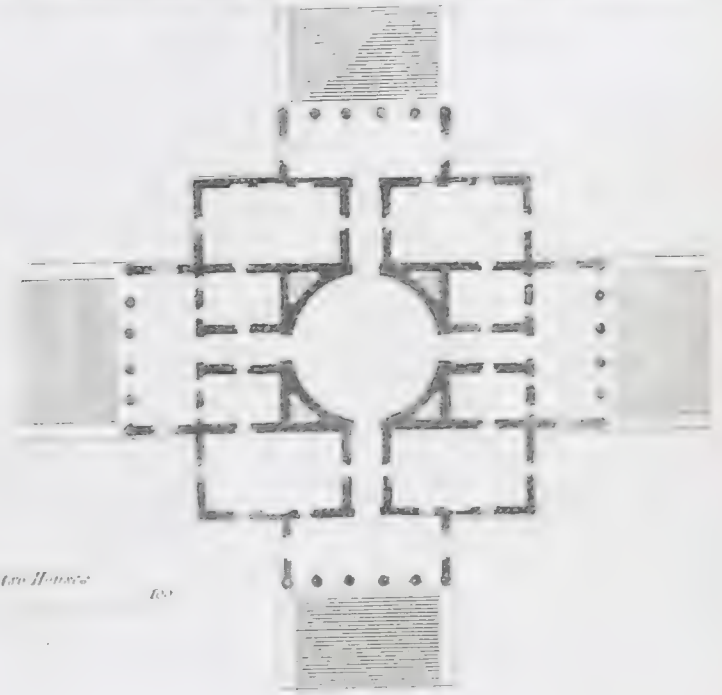
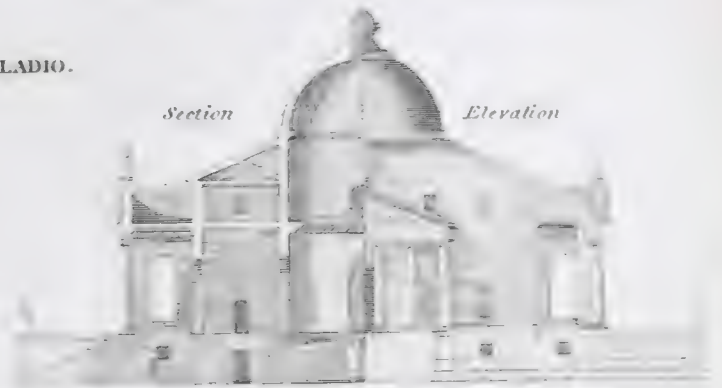


PLAN and ELEVATION of a HOUSE on the TERRACE at VICENZA in ITALY.

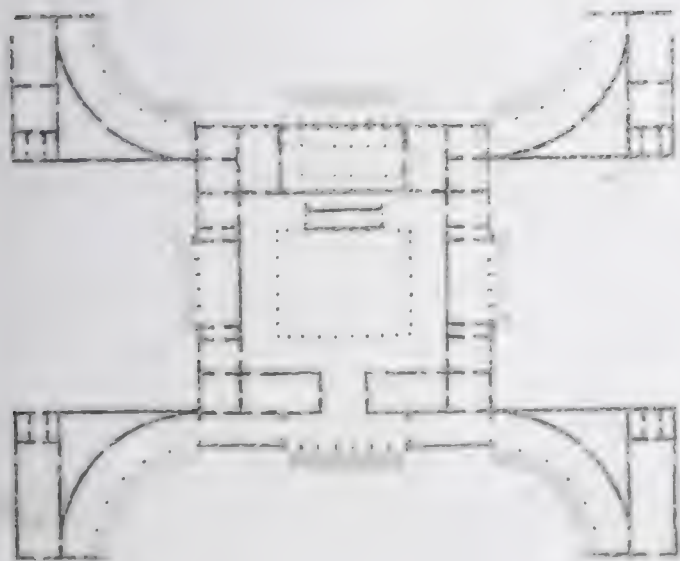
FROM PALLADIO.



VILLA on the BANK of the RIVER BACUGLIONE near VICENZA.



Scale of Feet for the above two Houses



PLAN and ELEVATION of a DESIGN for a VILLA by PALLADIO.





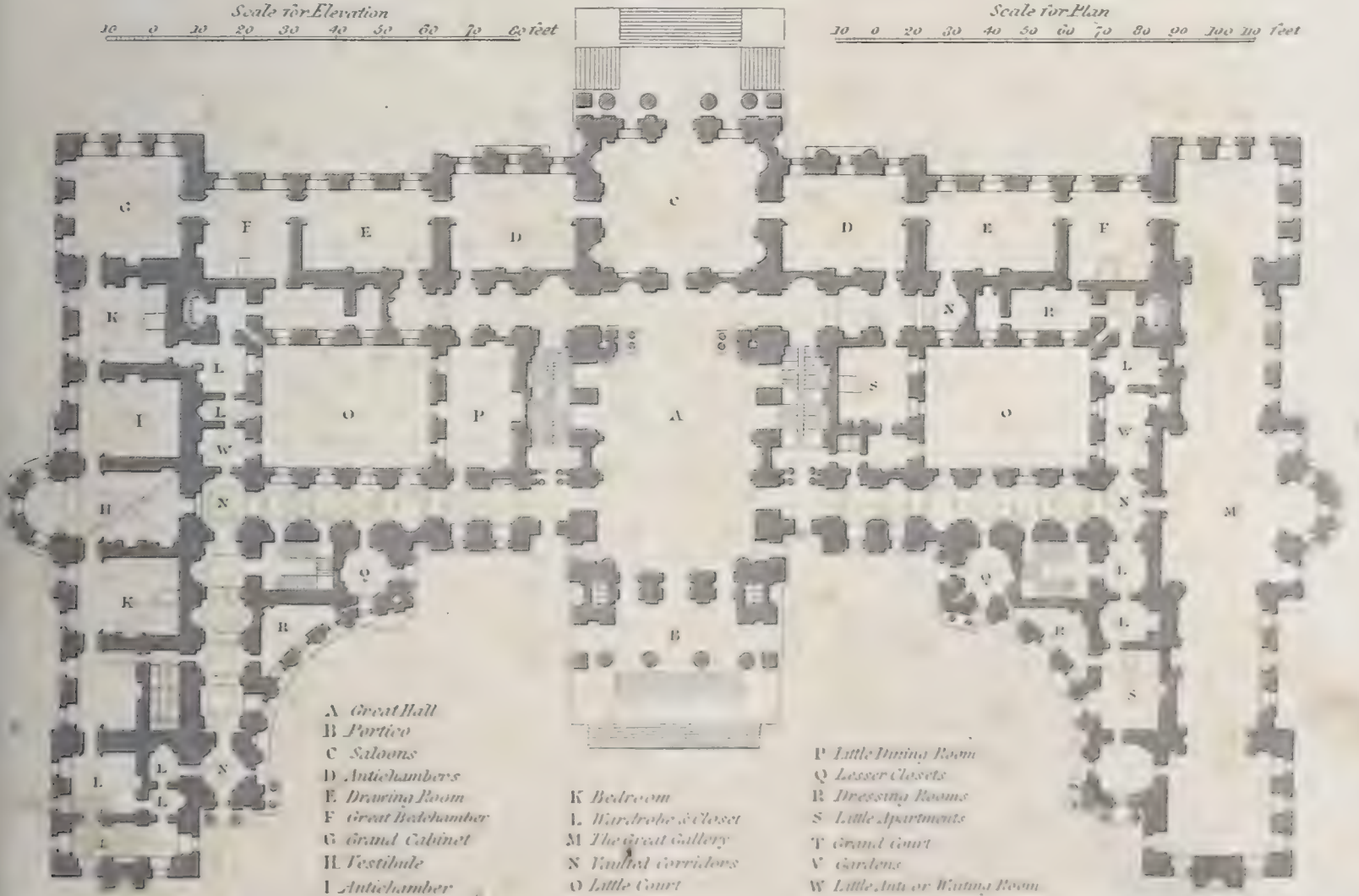


Elevation of one half of the principal Front of Blenheim in Oxfordshire

Plan of the Principal Floor

Scale for Elevation  
10 0 20 30 40 50 60 70 80 feet

Scale for Plan  
10 0 20 30 40 50 60 70 80 90 100 110 feet



- A Great Hall
- B Portico
- C Saloons
- D Antichambers
- E Drawing Room
- F Great Bedchamber
- G Grand Cabinet
- H Vestibule
- I Antichamber

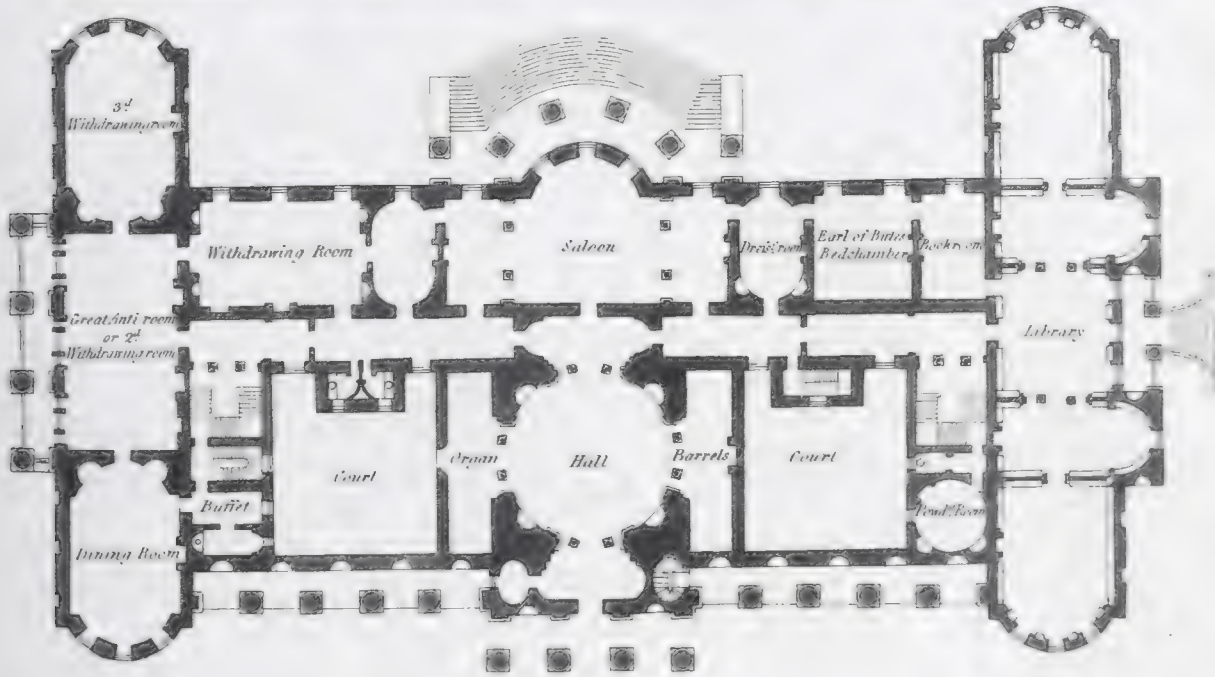
- K Bedroom
- L Wardrobe & Closet
- M The great Gallery
- N Vaulted Corridors
- O Little Court

- P Little Dining Room
- Q Lesser Closets
- R Dressing Rooms
- S Little Apartments
- T Grand Court
- V Gardens
- W Little Anti or Waiting Room



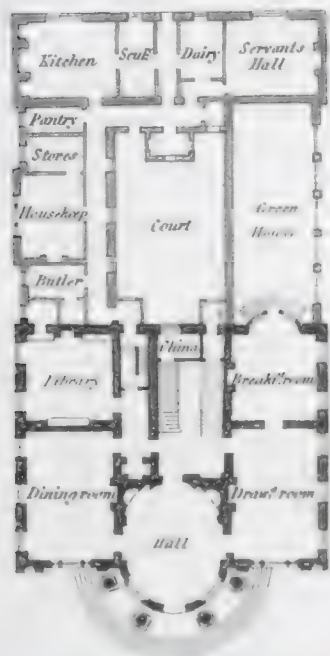
ELEVATION and PLAN of the EARL of BUTES HOUSE in LUTON PARK, BEDFORDSHIRE.

Robt. Adam Arch<sup>t</sup>



PLAN and ELEVATION of the SEAT of BARNARD DICKINSON ESQ<sup>r</sup> in BOWDEN PARK, WILTSHIRE.

James Wyatt Arch<sup>t</sup>



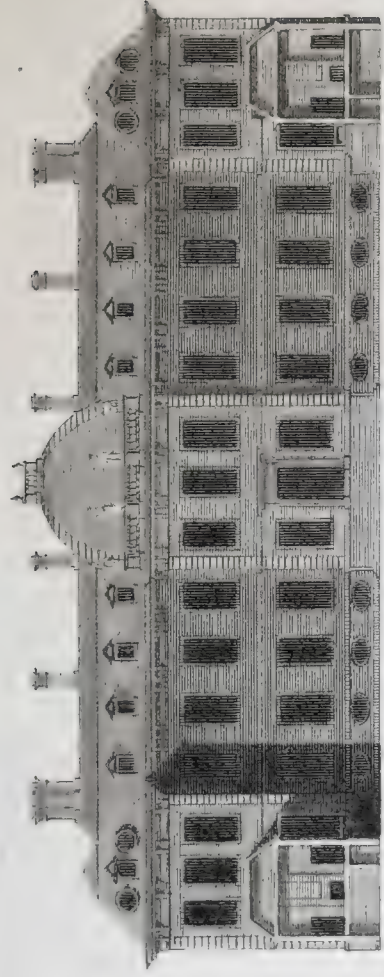
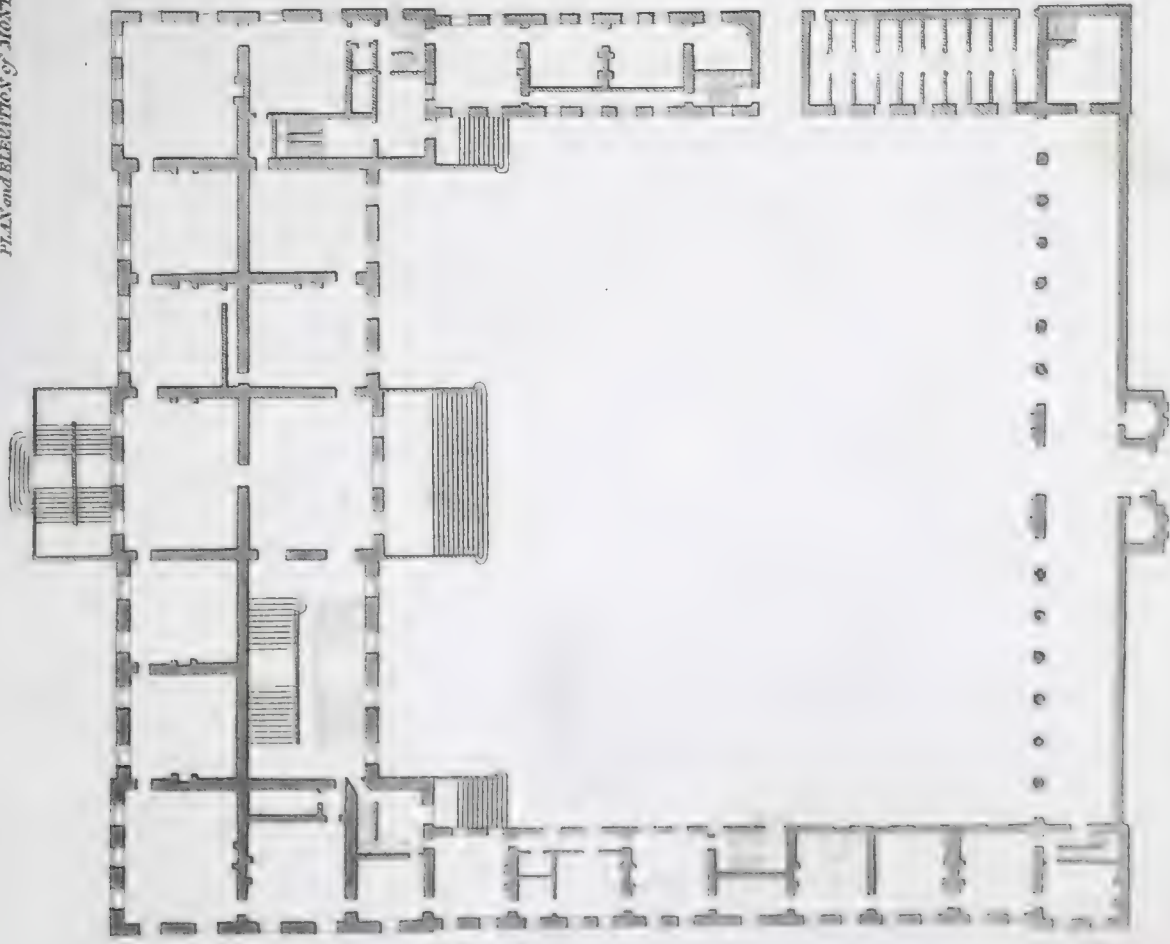
Scale for the whole Plate



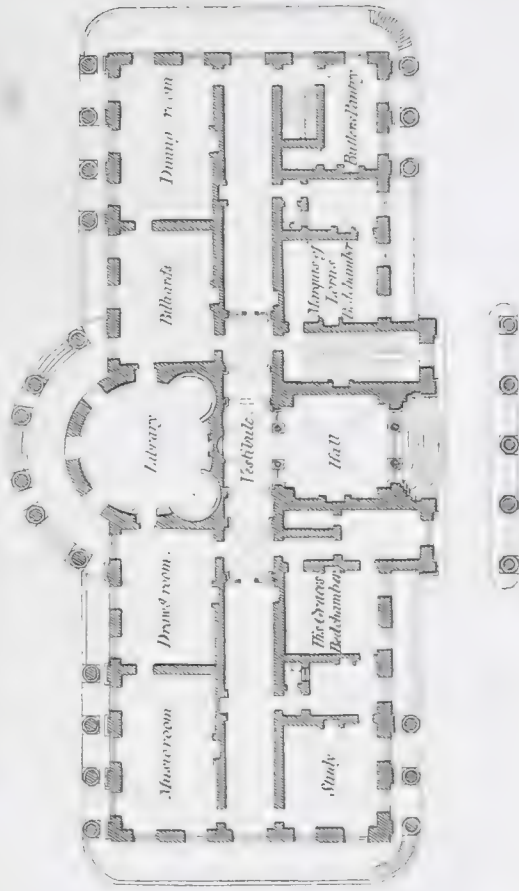




PLAN and ELEVATION of MONTAGUE HOUSE in GREAT RUSSEL ST LONDON.



PREFACE STUDY of ROSEWORTH a SECT of the GRACE the DUNCE of ARGILL in DUMFRIESSHIRE.



Scale of Feet.

100 200

Designed by H. Inwood.



Fig. 1.

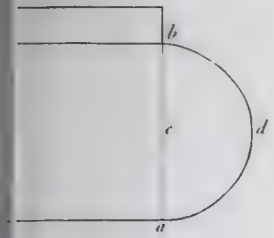


Fig. 2. N° 1.

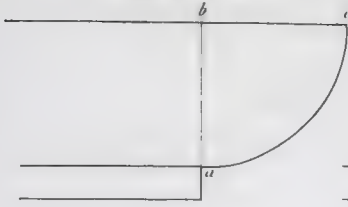


Fig. 2. N° 2

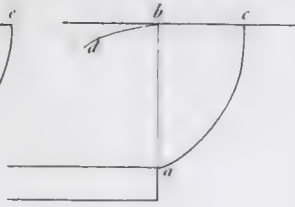


Fig. 3.

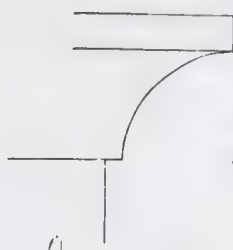


Fig. 4.

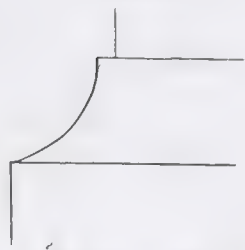


Fig. 5.

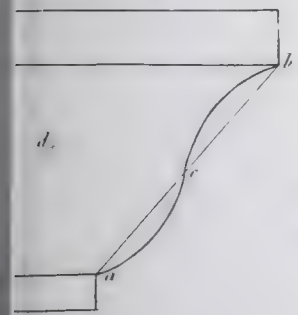


Fig. 6.

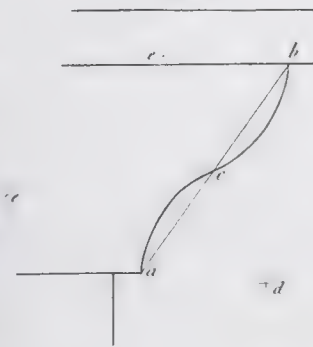


Fig. 7.

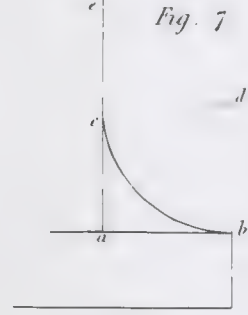


Fig. 8.

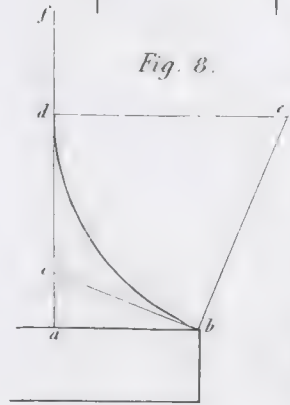


Fig. 9.

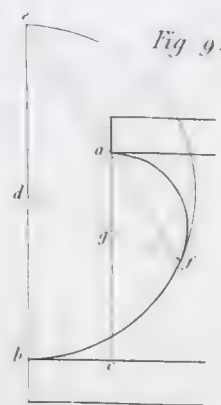


Fig. 10.

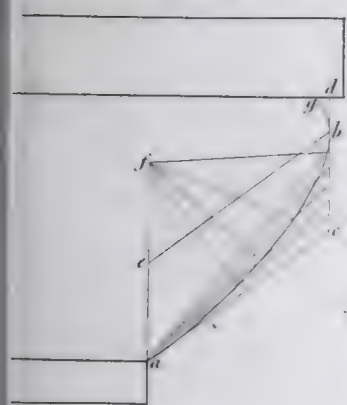


Fig. 11.

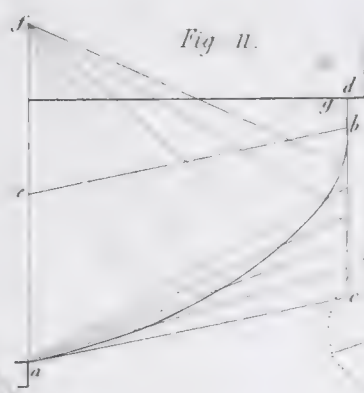


Fig. 12.

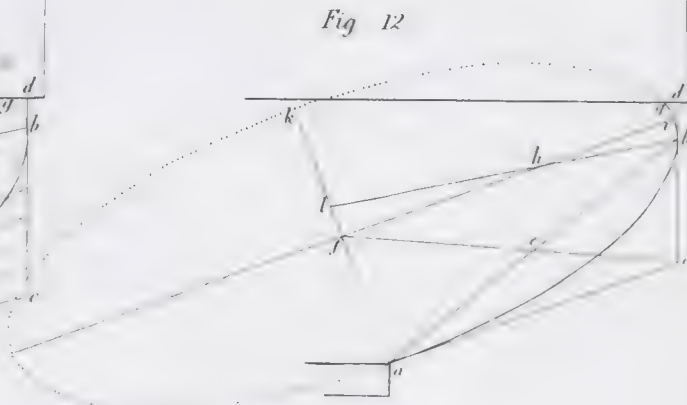


Fig. 13.

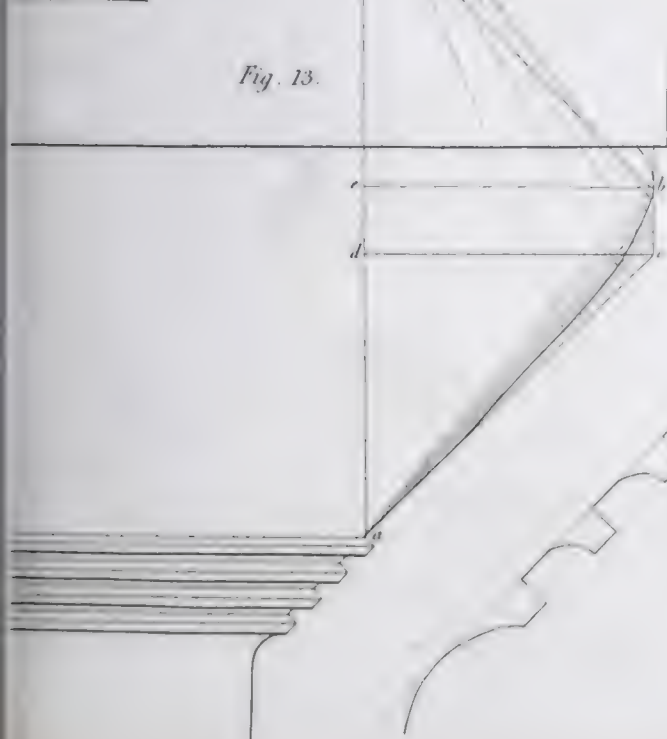


Fig. 15.

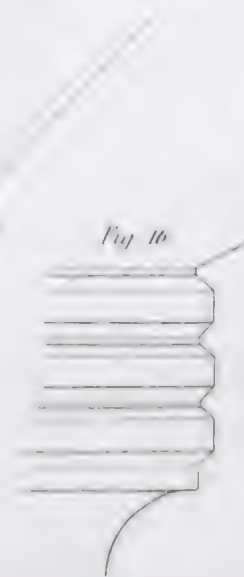


Fig. 11

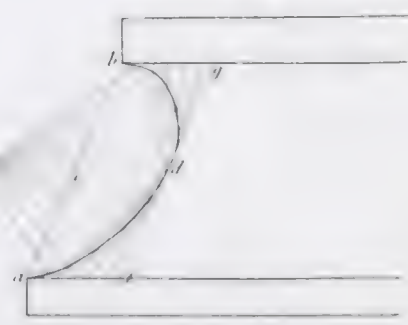


Fig. 17.





Fig. 1.

Fig. 2.

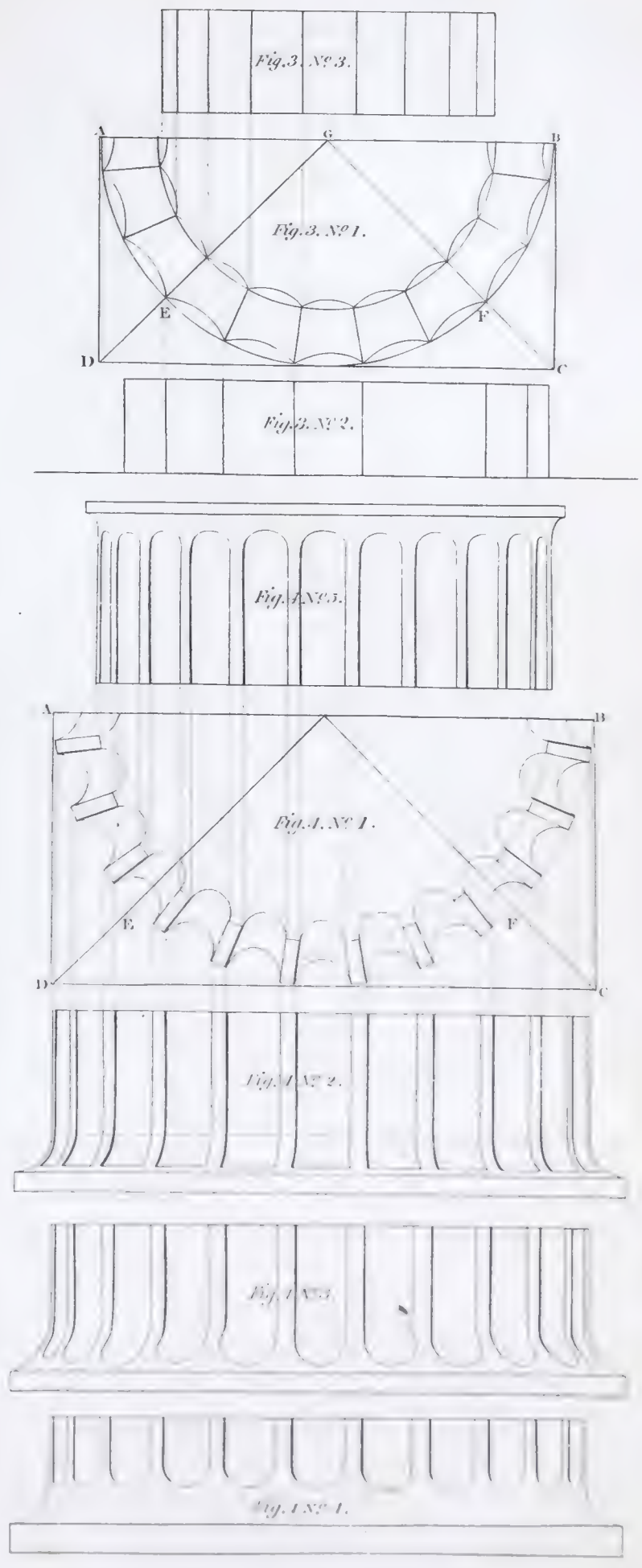




Fig. 1. N<sup>o</sup> 1.

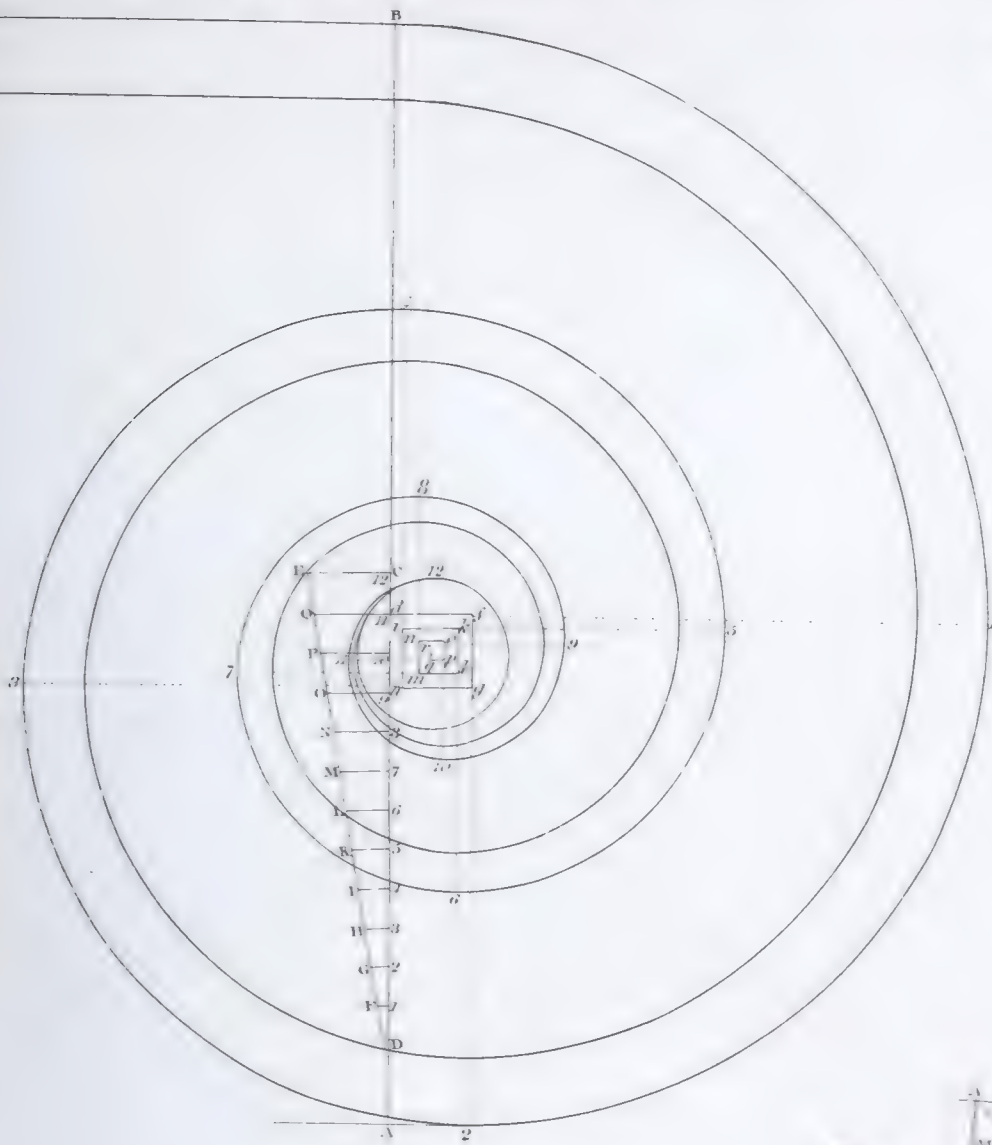


Fig. 1. N<sup>o</sup> 2.



Fig. 2. N<sup>o</sup> 1.

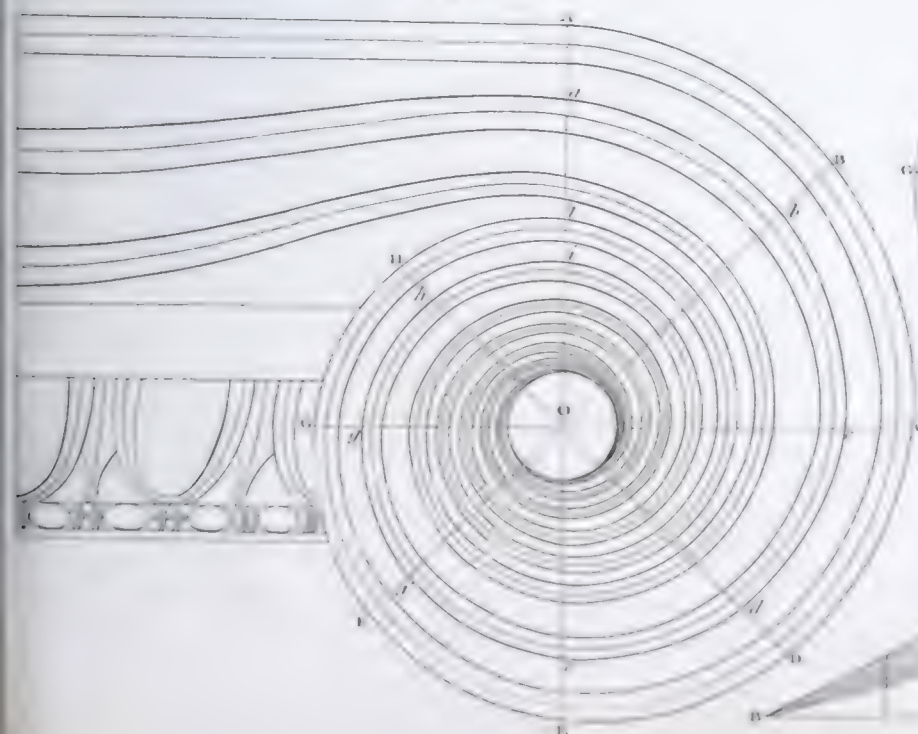


Fig. 3.

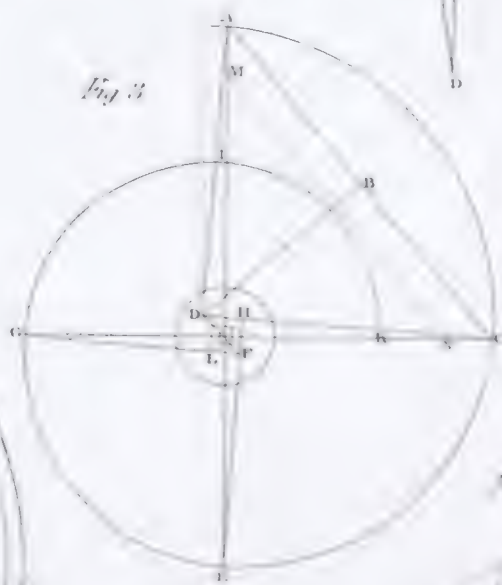


Fig. 2. N<sup>o</sup> 2.







Fig. 1. N° 2.

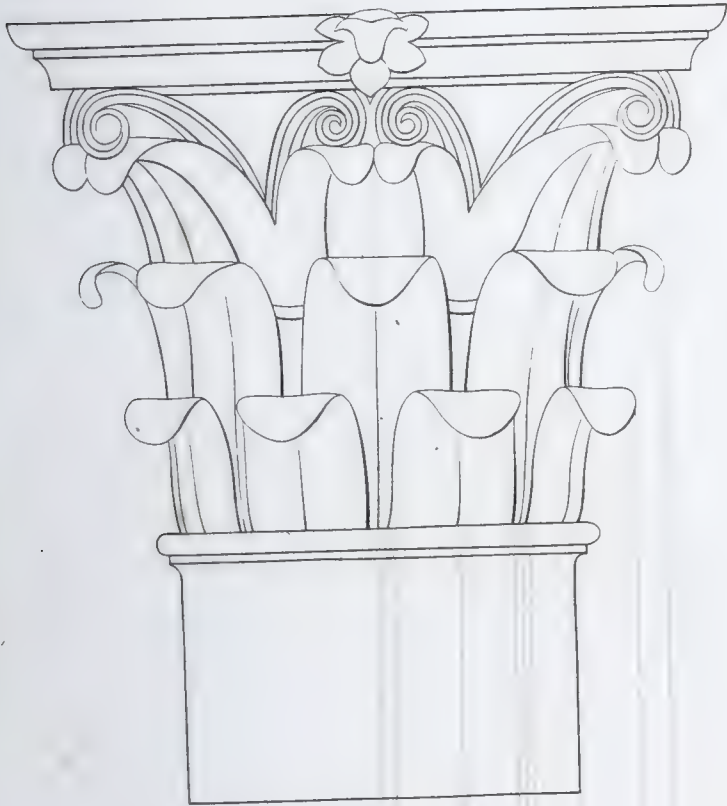


Fig. 1. N° 1.

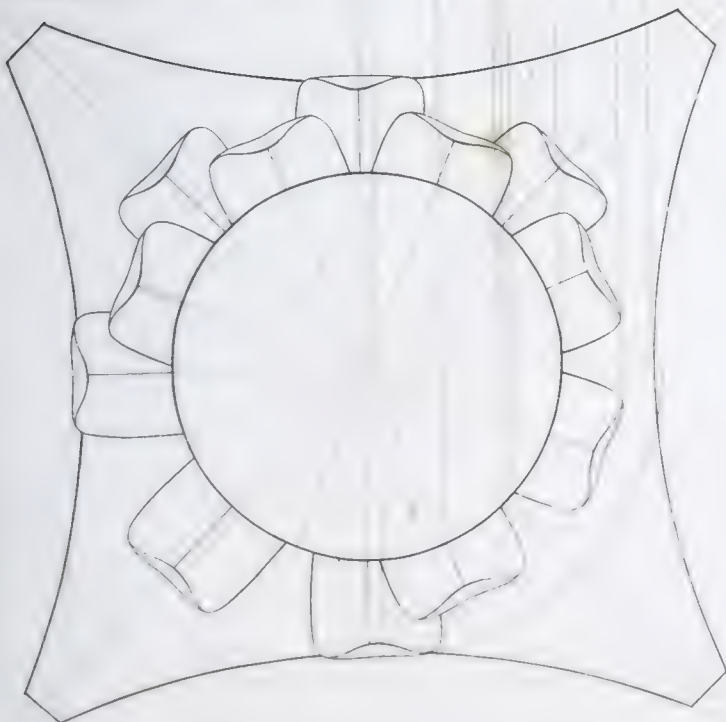


Fig. 2. N° 2.



Fig. 2. N° 1.

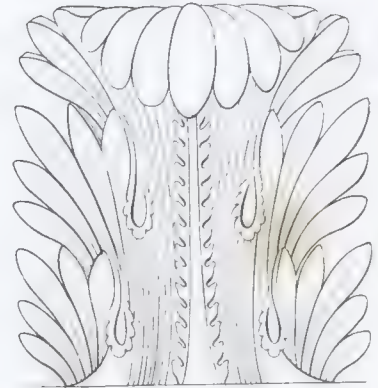


Fig. 3

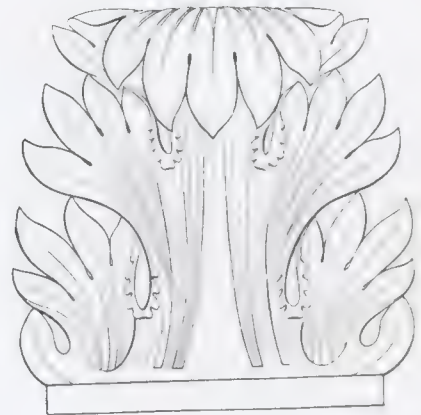


Fig. 4. N° 1

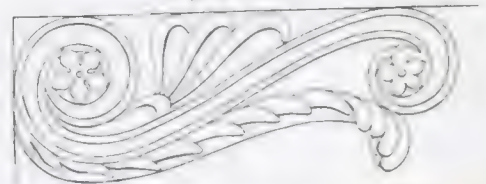
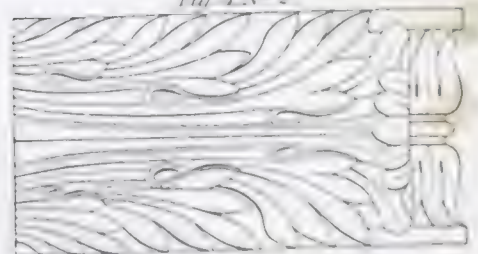
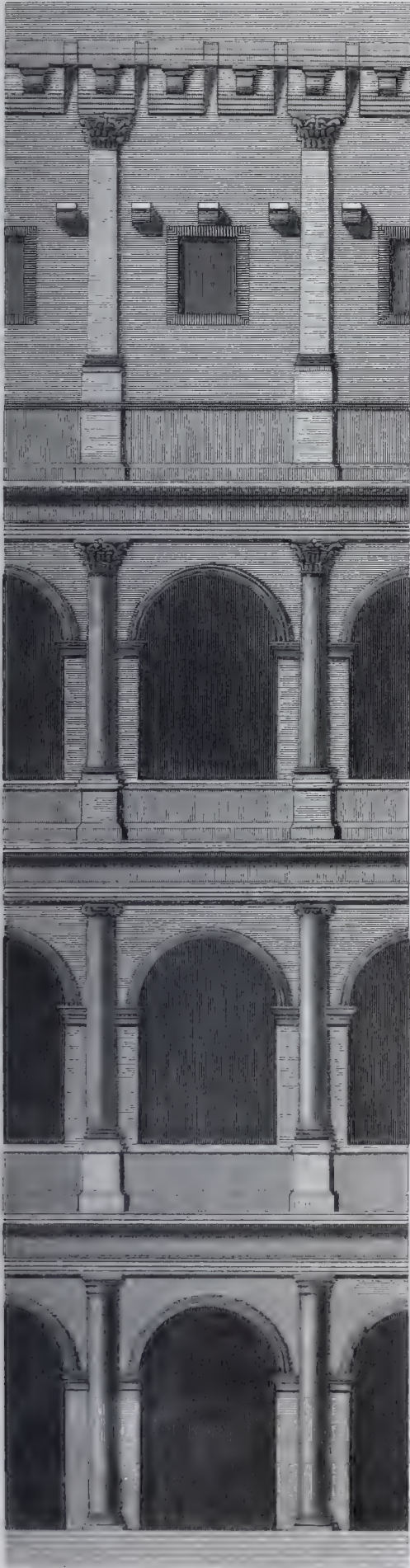


Fig. 4. N° 2

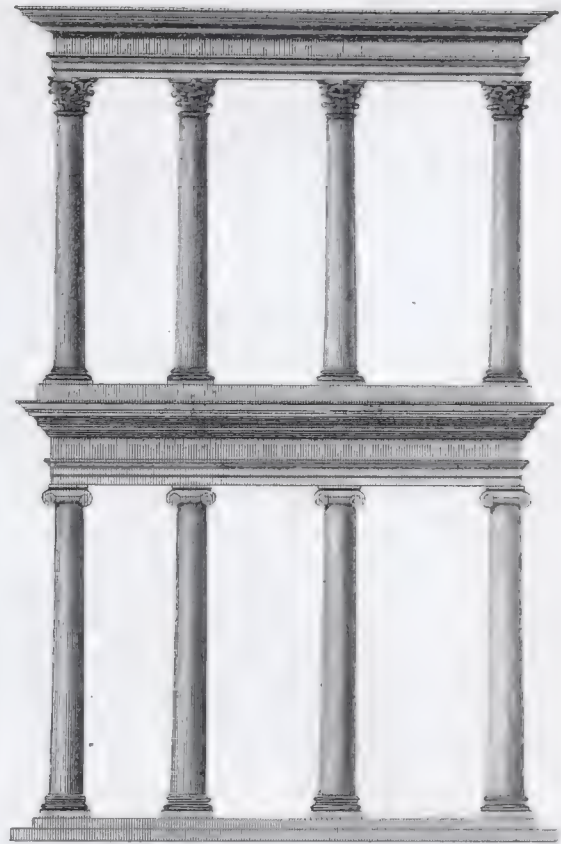




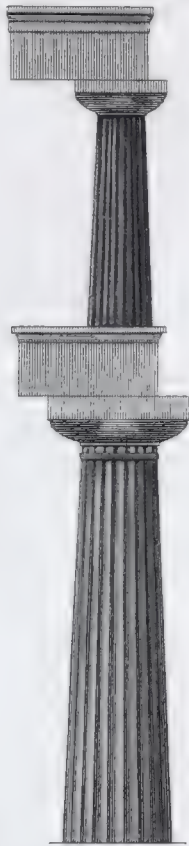
COLISEUM AT ROME.



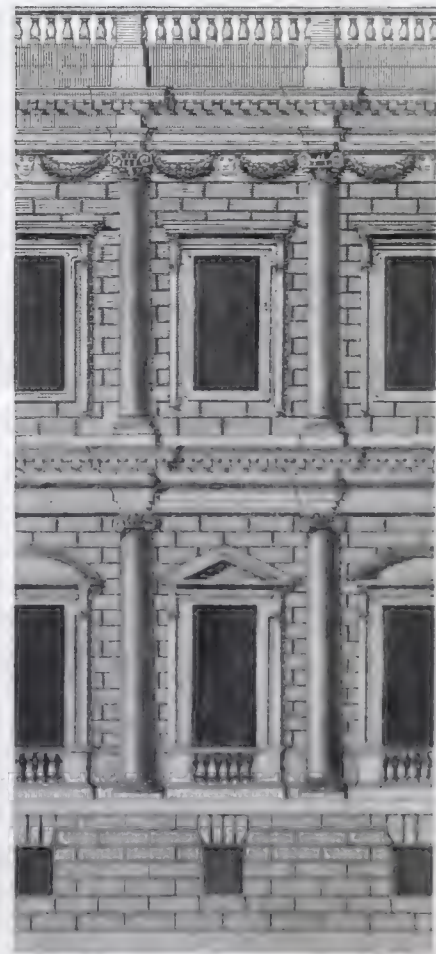
PETER NICHOLSON.



TEMPLE AT PAESTUM.



WHITEHALL.



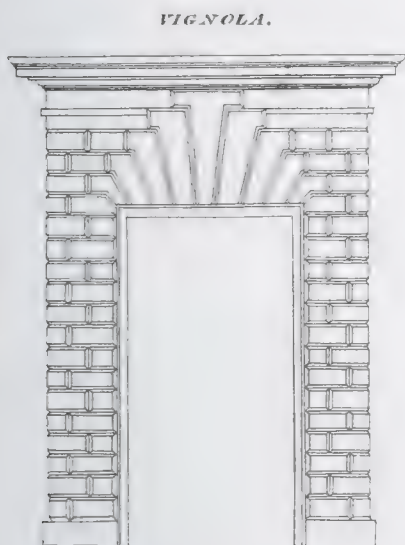
THEATRE OF MARCELLUS AT ROME.





DOORS.

VIGNOLA.



VIGNOLA.



VIGNOLA.



MICHAEL ANGELO.



SERLIO.



PALLADIO.



WINDOWS.

PALLADIO.



INIGO JONES.





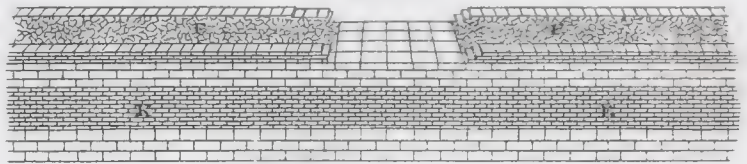
WALLS FROM VITRUVIUS'S AND PALLADIO.

GREEK.  
Fig. 1.



FROM THE ROTUNDA AND BATHS OF DIOCLESIAN.

Fig. 7.



TURIN IN PIEDMONT.

Fig. 8.

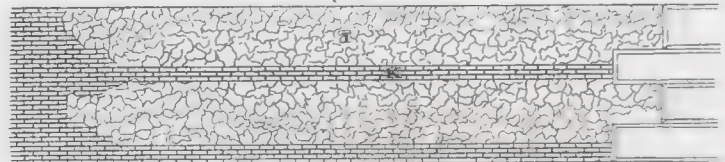
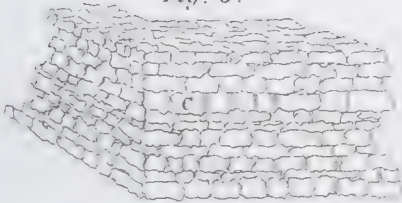
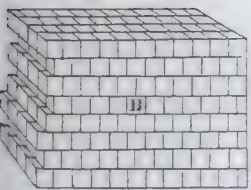


Fig. 2.

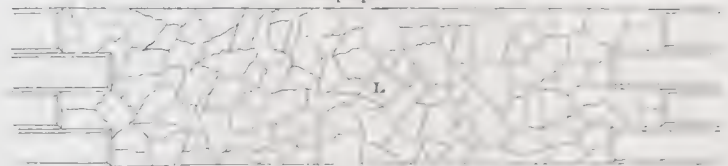
GREEK.

Fig. 3.



PRÆNESTE IN ITALY.

Fig. 9.

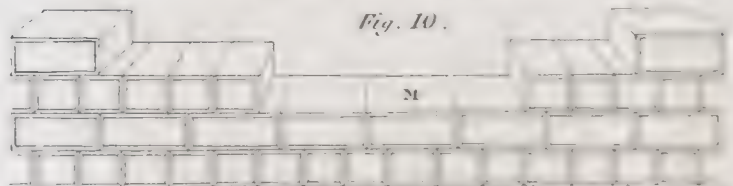


GREEK.  
Fig. 4.



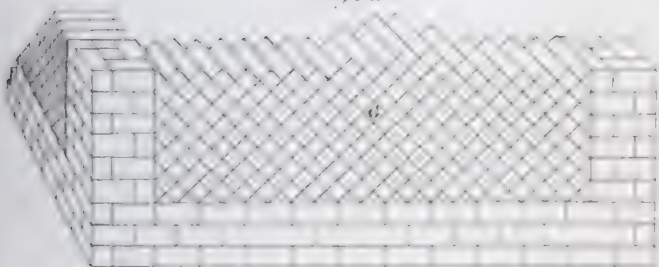
FROM THE TEMPLE OF AUGUSTUS AT ROME.

Fig. 10.



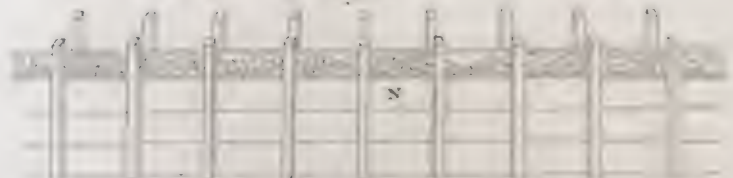
ANCIENT ROMAN.

Fig. 5.



AT SIRMION UPON THE LAKE OF GARDA

Fig. 11

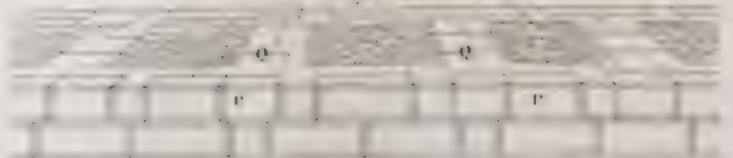


BY PALLADIO.  
Fig. 6.



AT NAPLES ANCIENT.

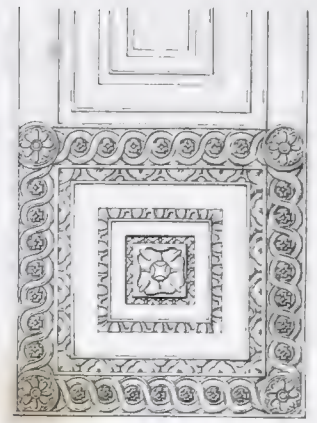
Fig. 12



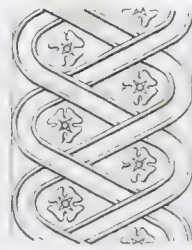
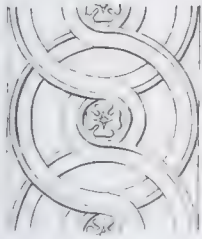
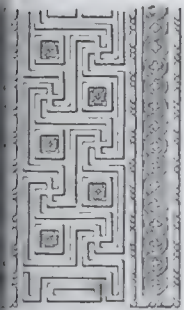




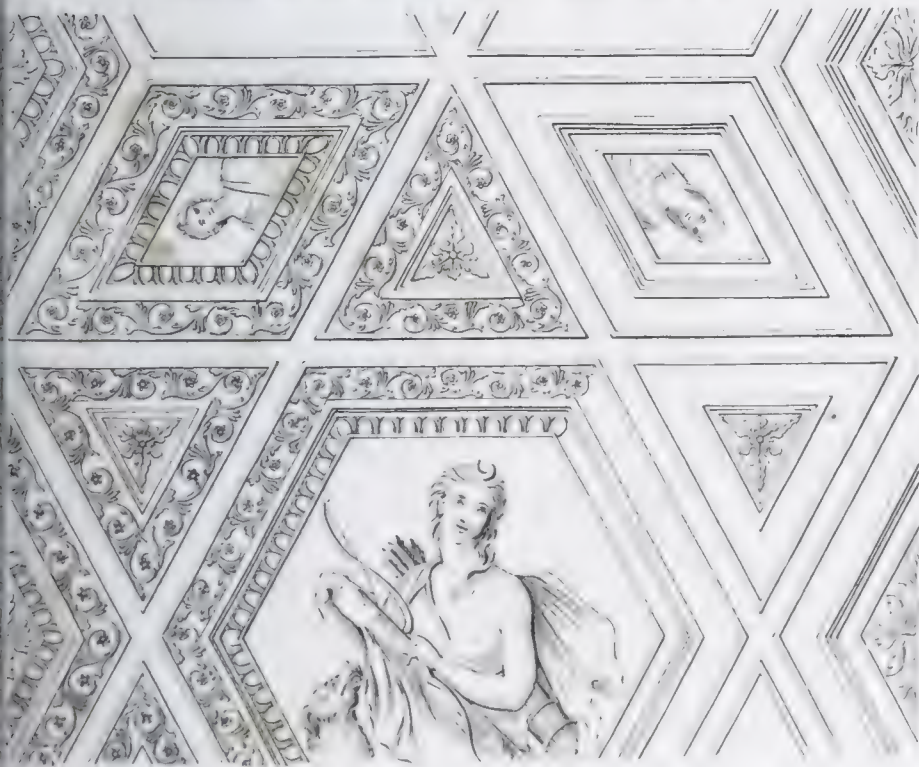
*Designs for Ceilings from Sir W<sup>m</sup> Chambers.*



*Frets and Guillochis from Sir W<sup>m</sup> Chambers.*



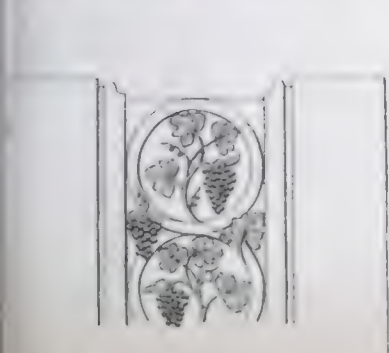
*Marble Soffit from the smaller Temple at Balbec.*



*Marble Soffit from the Temple of the Sun at Palmyra.*

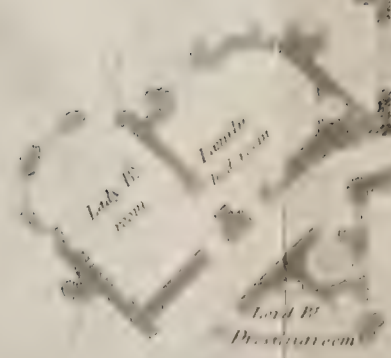


*Three enriched Pilasters from Palmyra.*





North Elevation and Plan of the Principal Story of Ashridge a Seat





*Earl of Bridgewater in Hertfordshire and Buckinghamshire.*





PRINCIPLE OF TEXTURE

Fig. 1.



OPEN FABRIC

Fig. 2.



CLOSE FABRIC

Fig. 3.



OPEN FABRIC

Direction & Ratio of Contraction

Fig. 4.



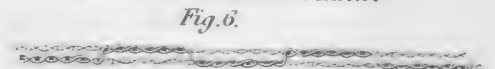
COMMON FABRIC

Fig. 5.



DOUBLE or CARPET FABRIC

Fig. 6.



TWEELED FABRIC

Fig. 7.



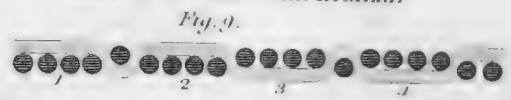
VELVET FABRIC

Fig. 8.



DIMITY DIAPER KERSEYMERE

Fig. 9.



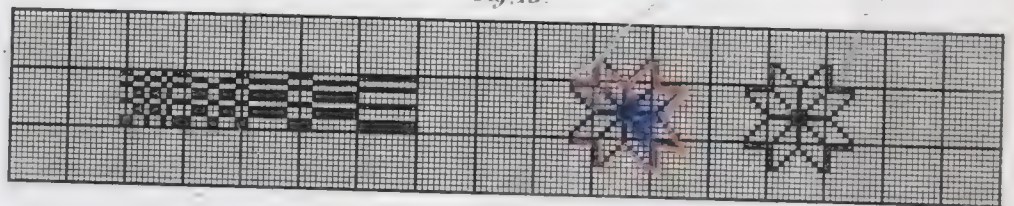
CORD DU ROT

Fig. 10.



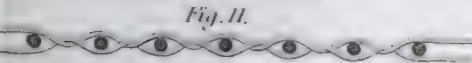
DORNOCK AND DIAPER

Fig. 15.



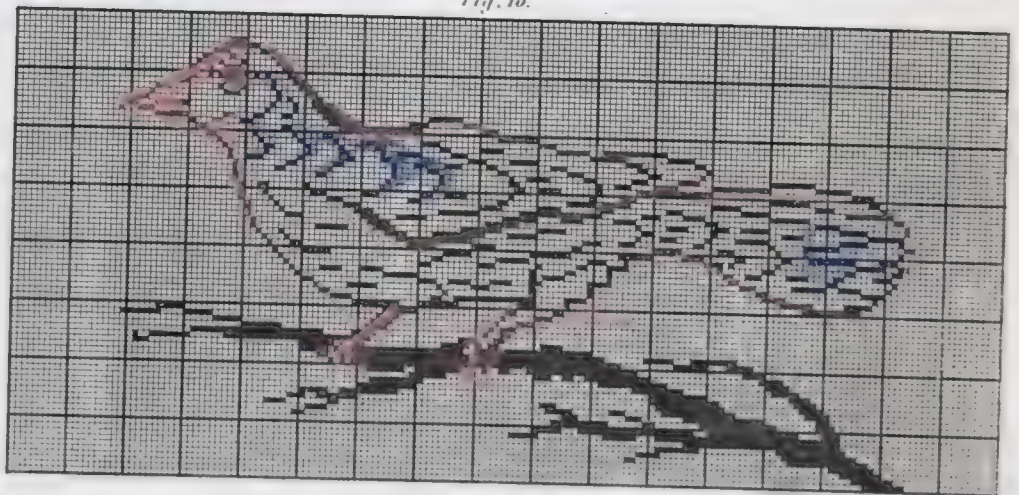
COMMON GAUZE

Fig. 11.



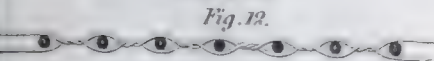
DAMASK AND TAPESTRY

Fig. 16.



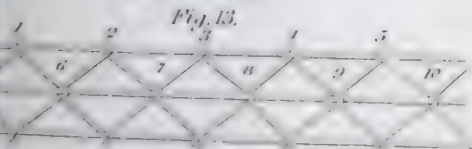
CATGUT

Fig. 12.



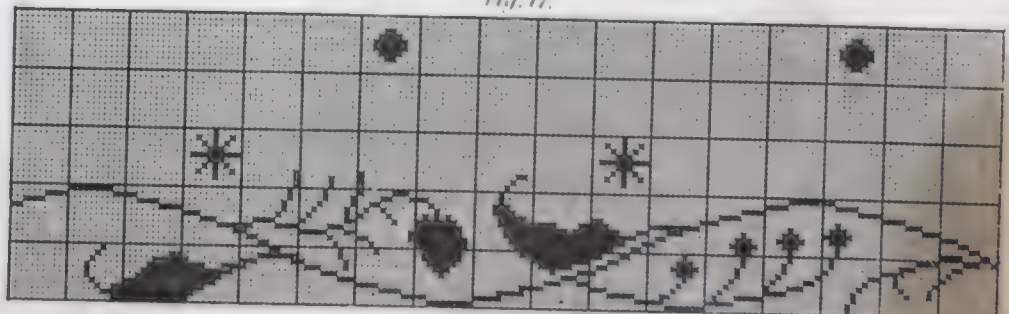
WHIP NET

Fig. 13.



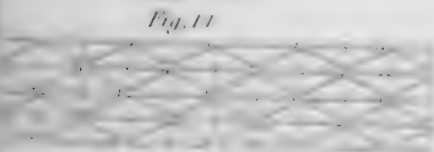
BORDERS, STRIPES AND SPOTTING

Fig. 17.



MILL NET

Fig. 14.





CONSTRUCTION OF LOOMS AND UTENSILS.

WARPING MILL.

Fig 1

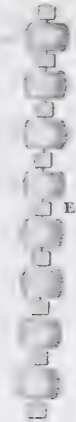


Fig 2.

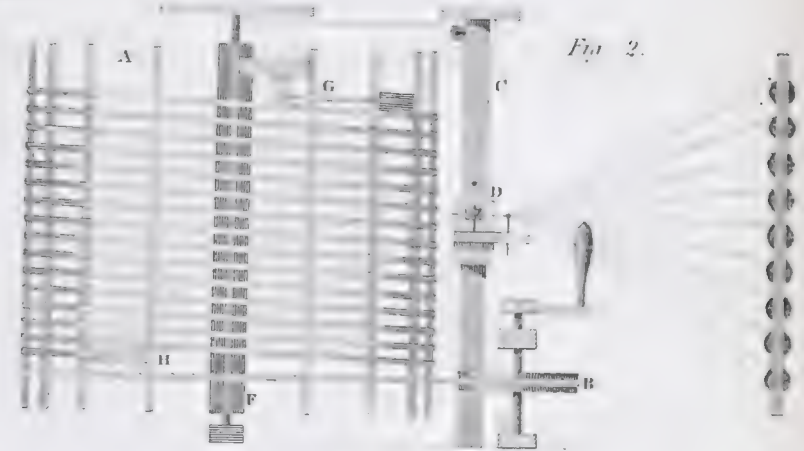


Fig. 3.

Fig. 3. N° 2.

Fig. 5.

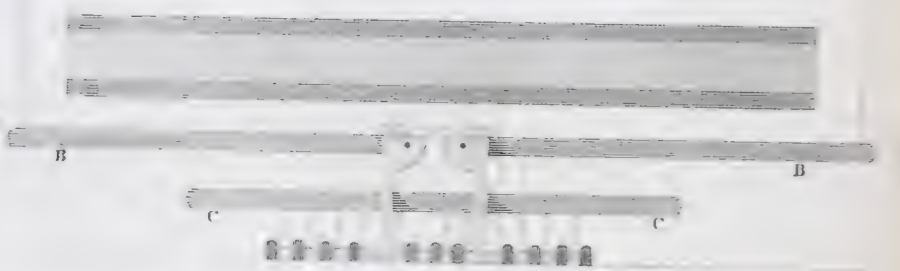
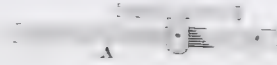
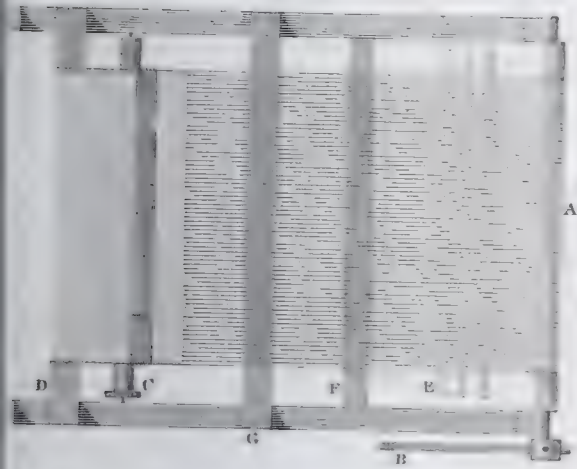


Fig. 6.

Fig. 4

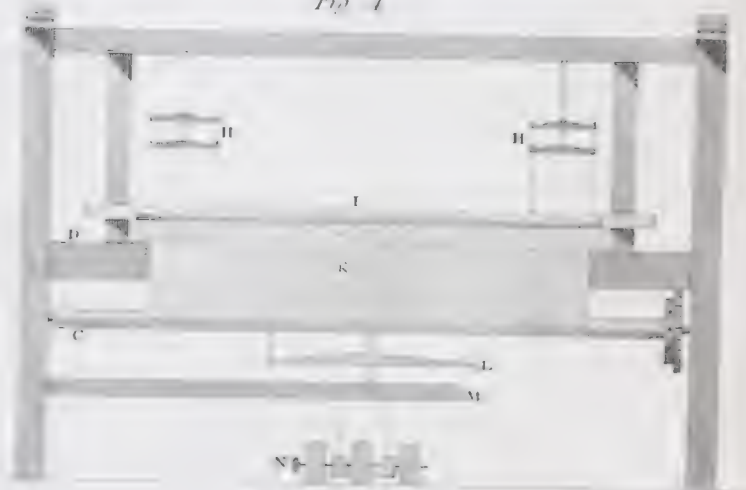
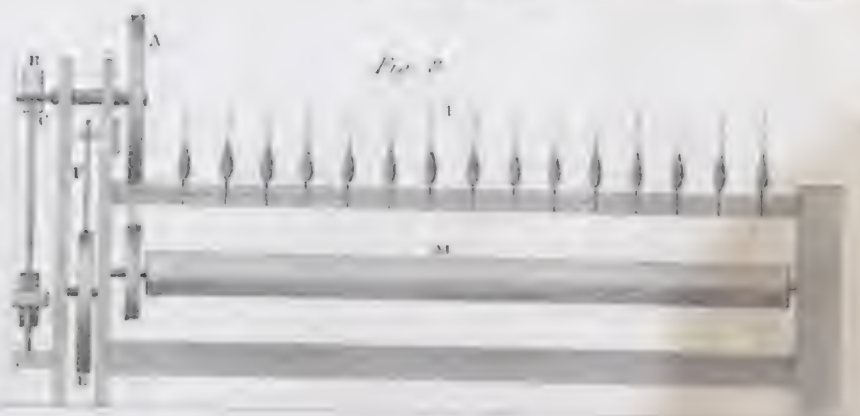
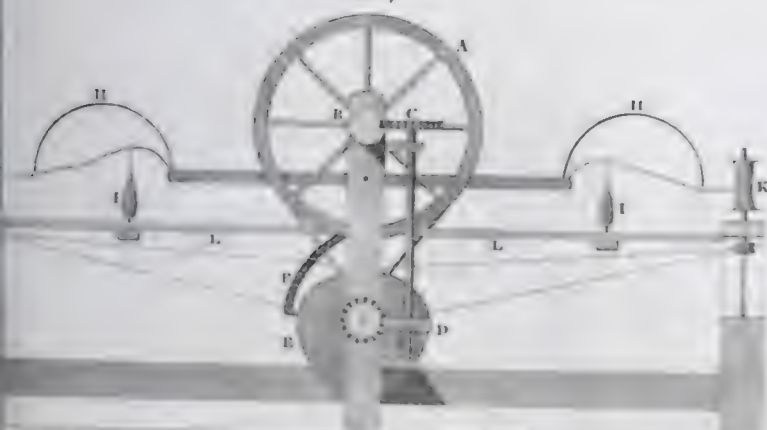


Fig. 7

Fig. 8



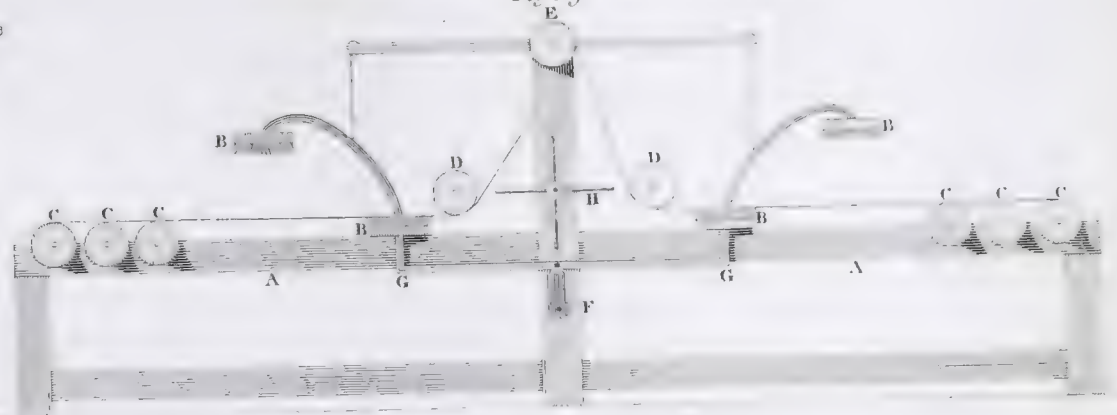




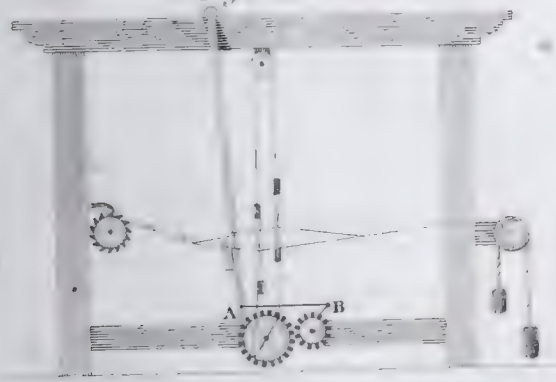
WIPER LOOM.  
Fig. 1.



STOCKPORT DRESSING MACHINE FOR COTTON.  
Fig. 9.



CRANK LOOM.  
Fig. 2.



BARROWFIELD DRESSING MACHINE.  
Fig. 11.

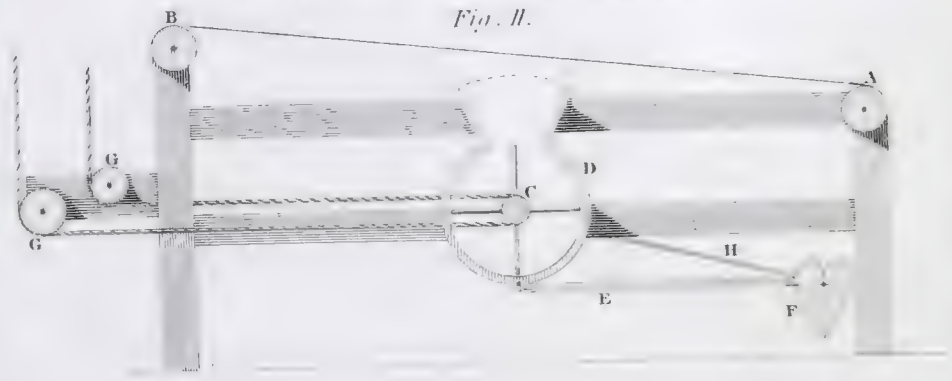


Fig. 5.



POLLOCKSHAW'S DRESSING MACHINE.  
Fig. 10.

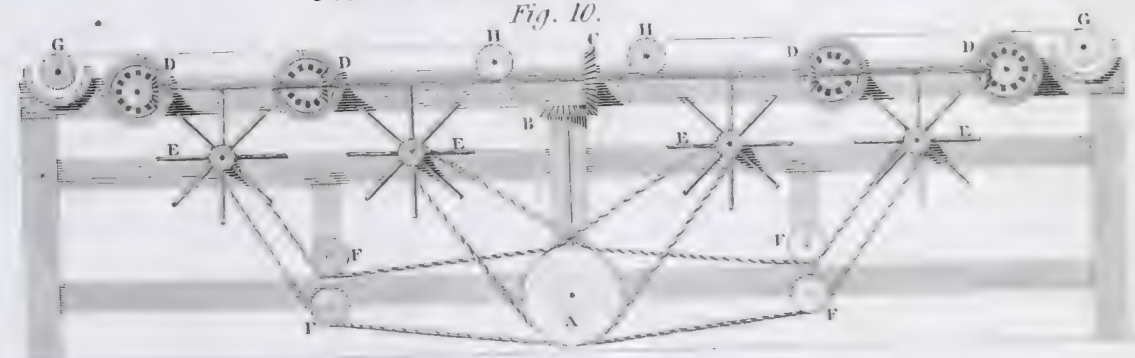
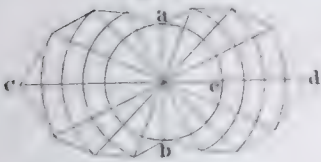


Fig. 6.



VIBRATING LOOM.  
Fig. 3.

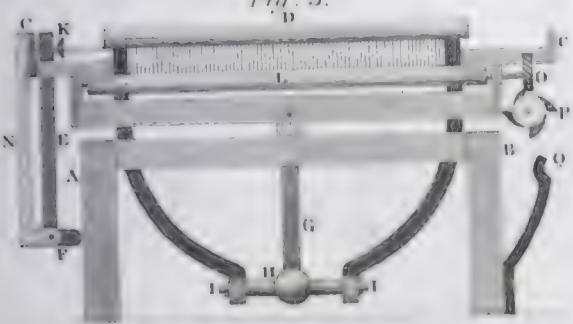


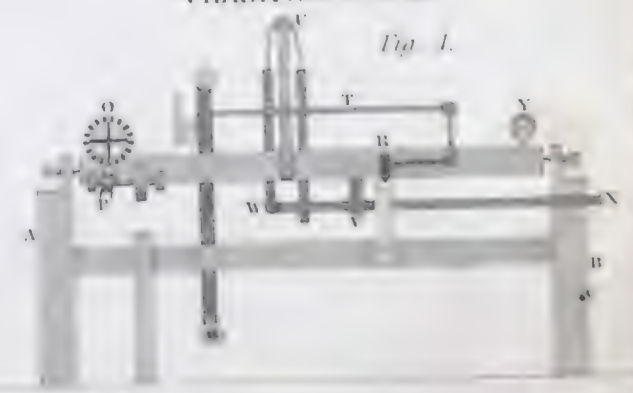
Fig. 7.



Fig. 8.

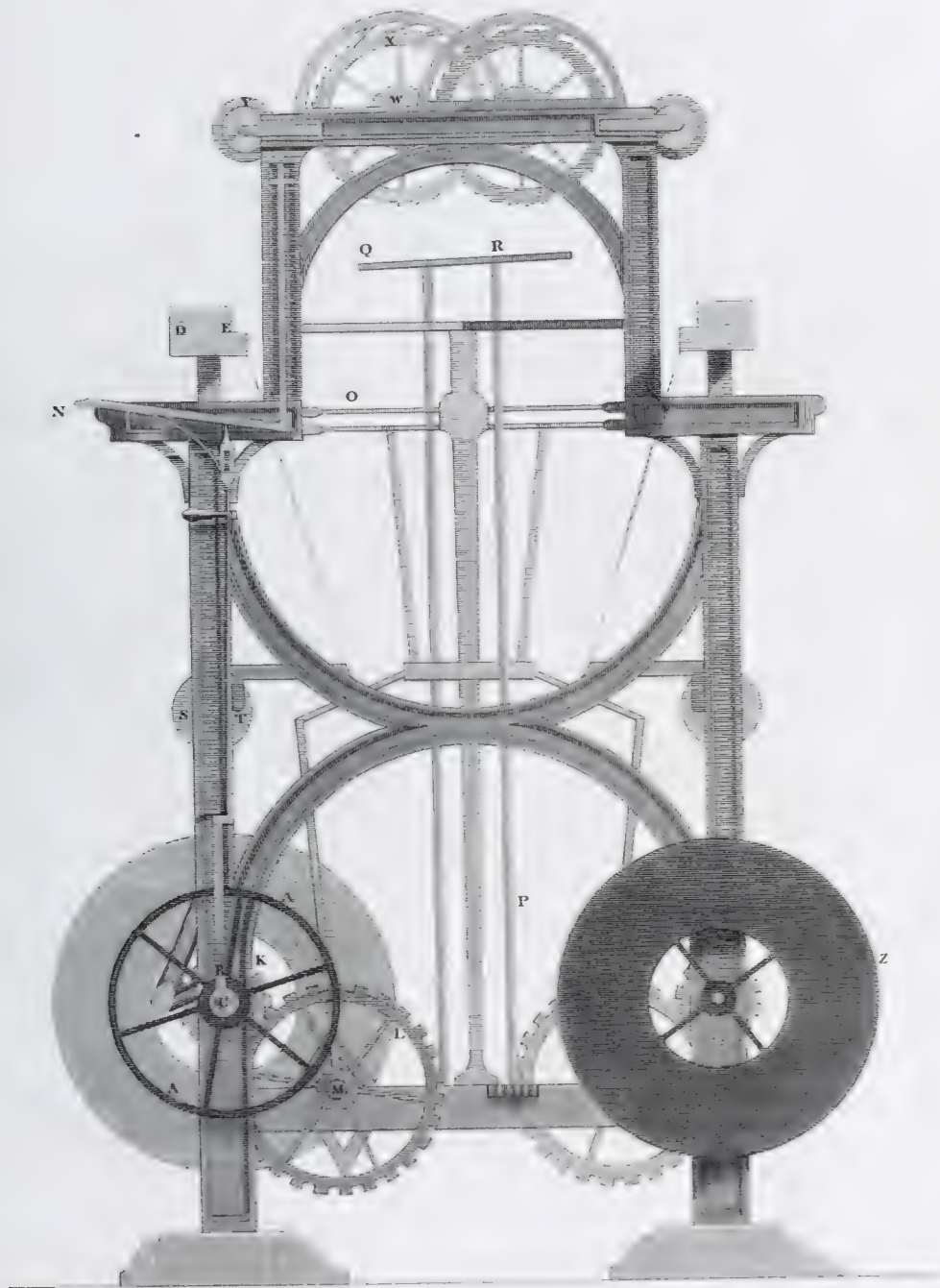


VIBRATING LOOM.  
Fig. 4.





JOHNSON'S VERTICAL LOOM.





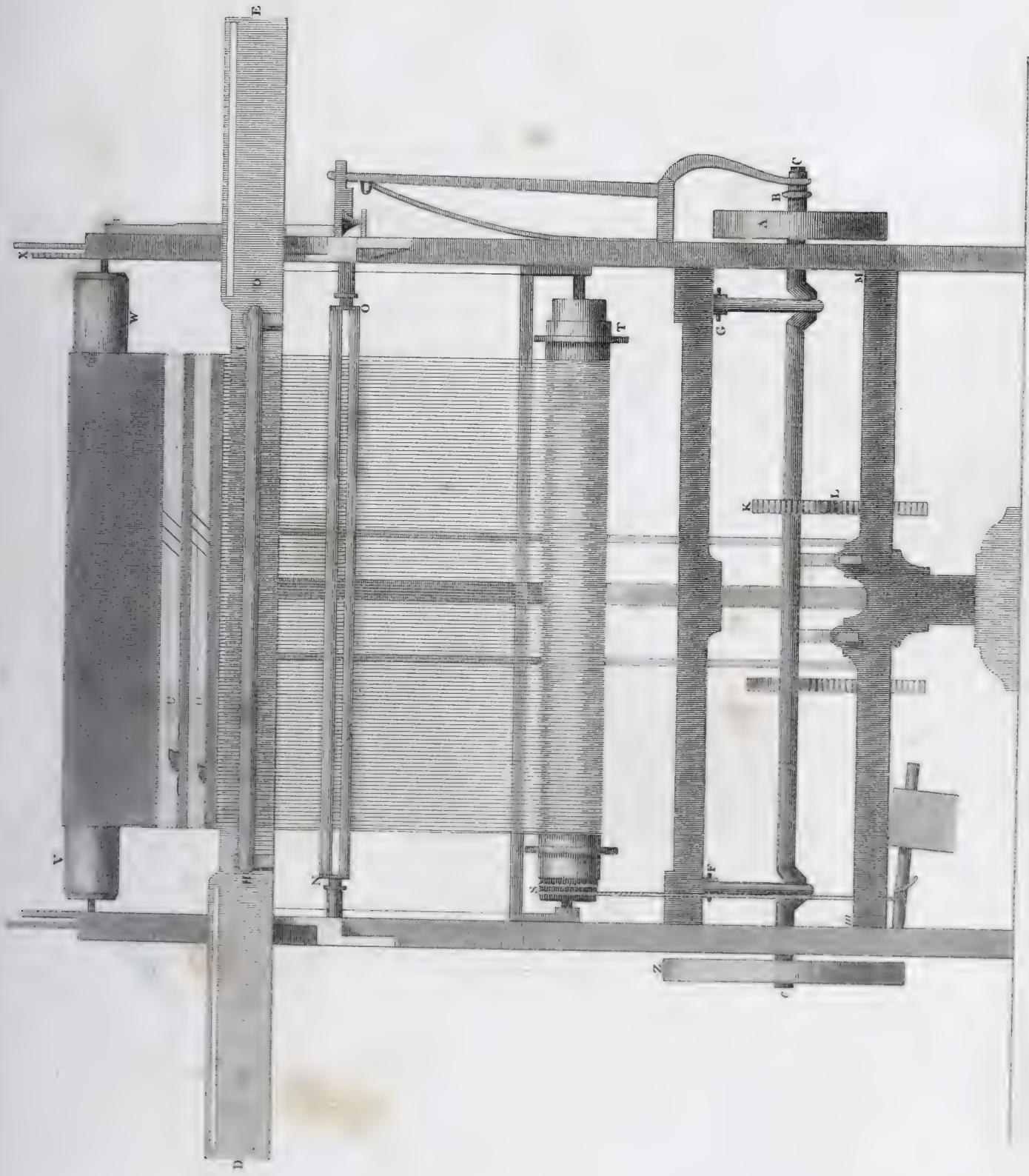




Fig. 2.

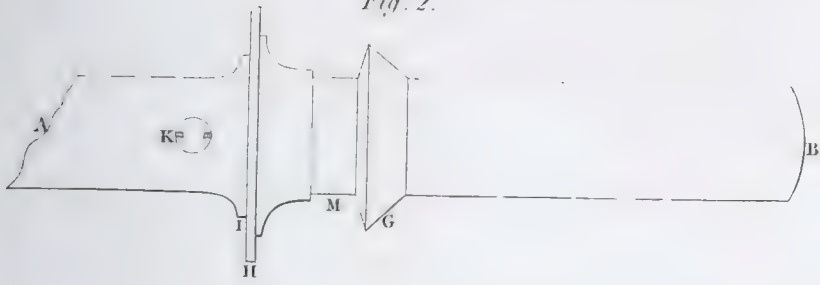


Fig. 3.



Fig. 6.

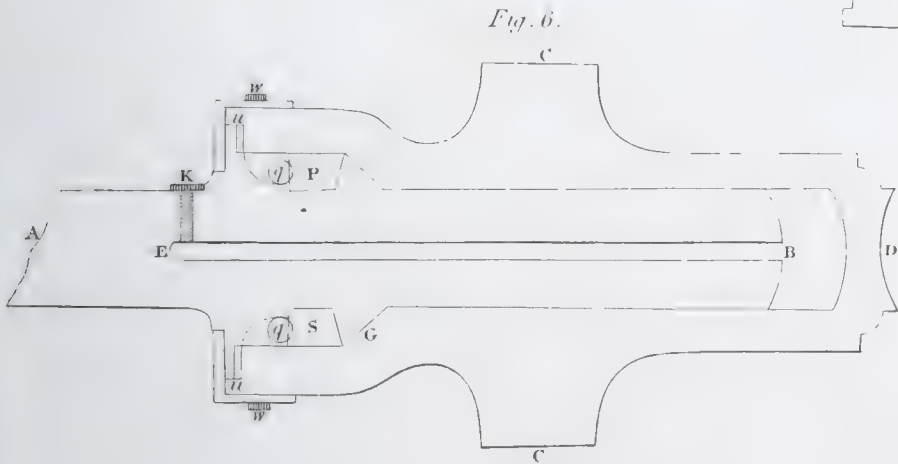


Fig. 1.

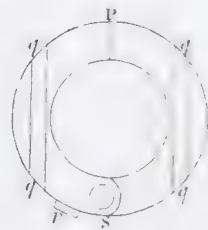


Fig. 5.

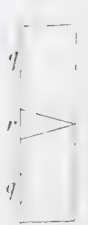
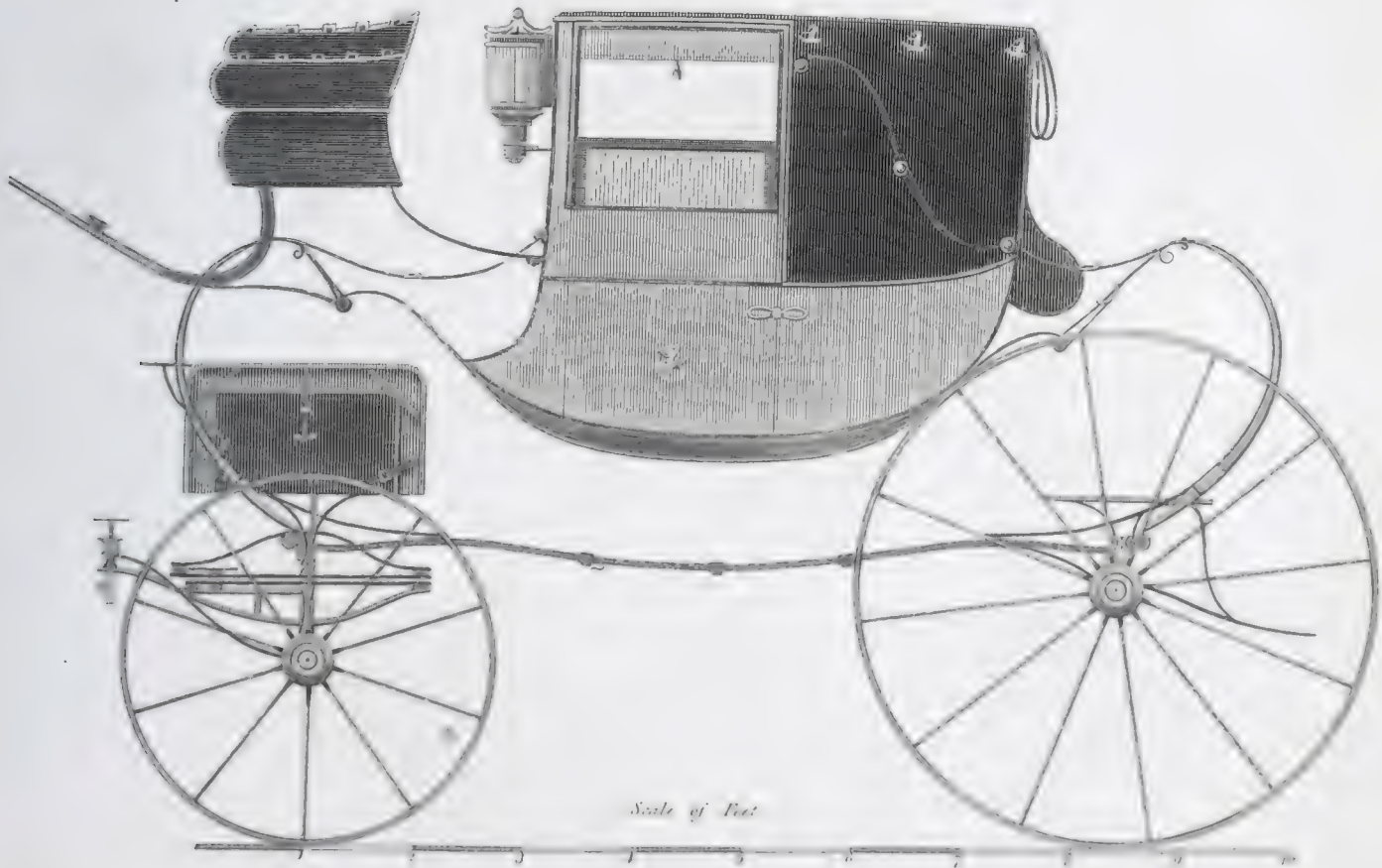


Fig. 1.



Scale of Feet

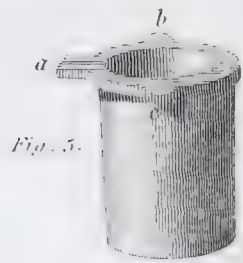
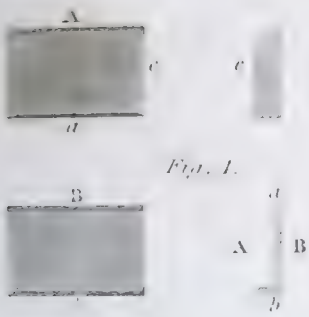




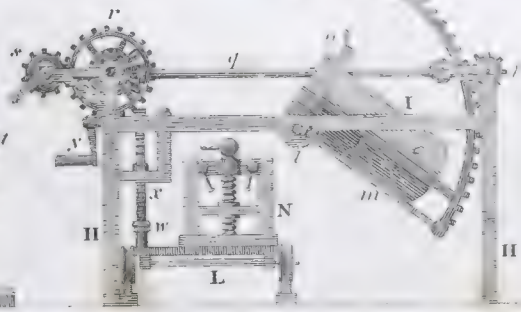
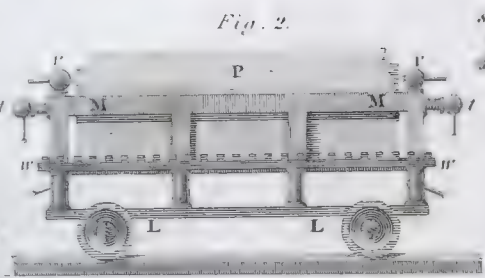
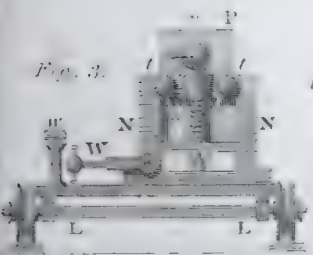
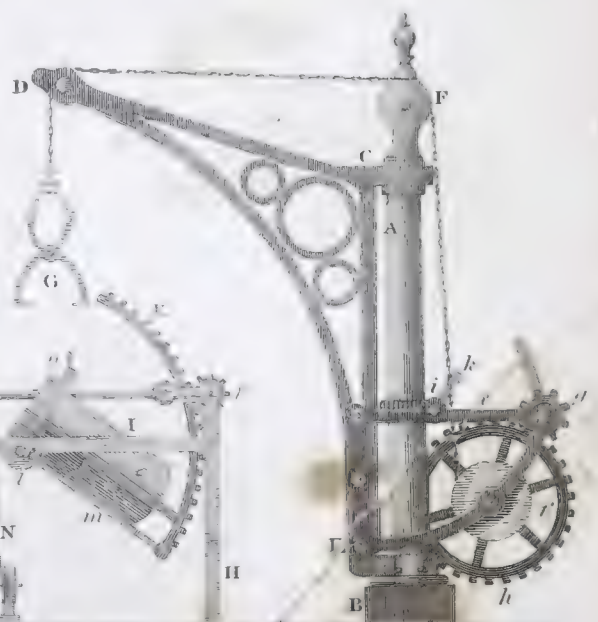




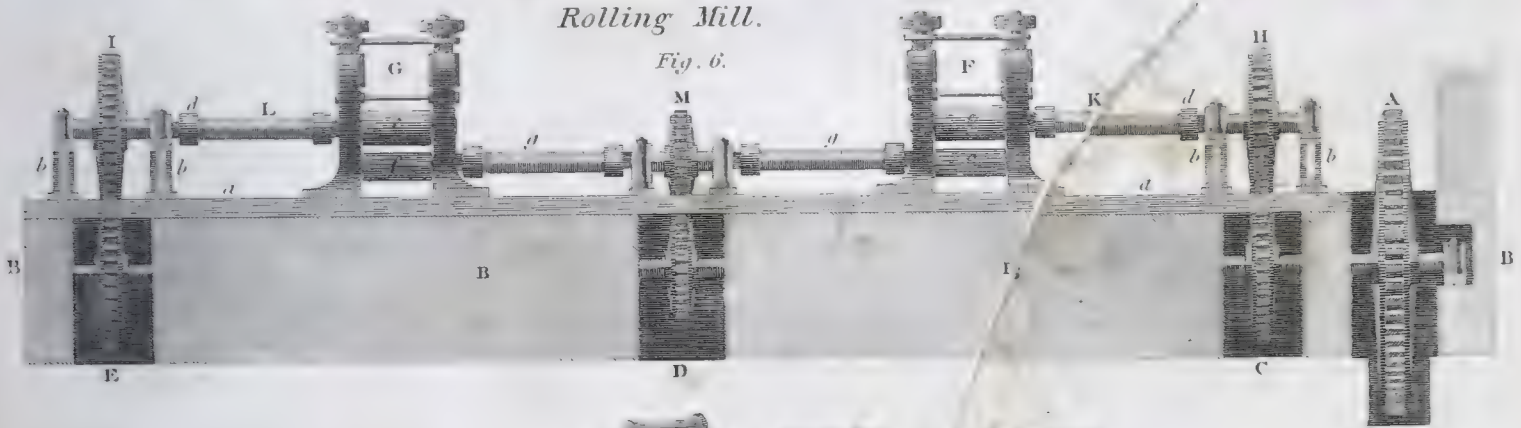
Machinery used in the Royal Mint.



Pouring Machine.



Rolling Mill.



View of the Rollers.

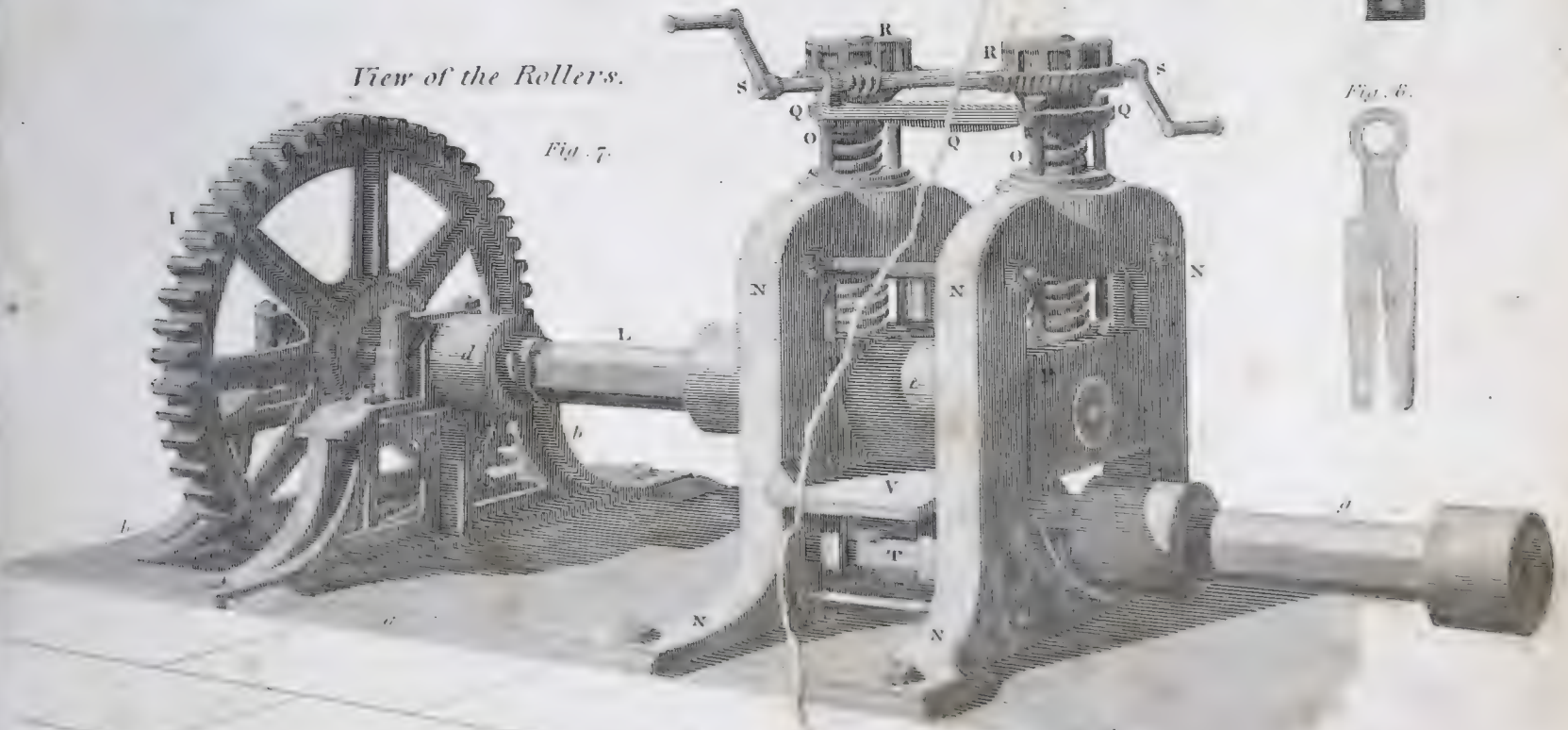


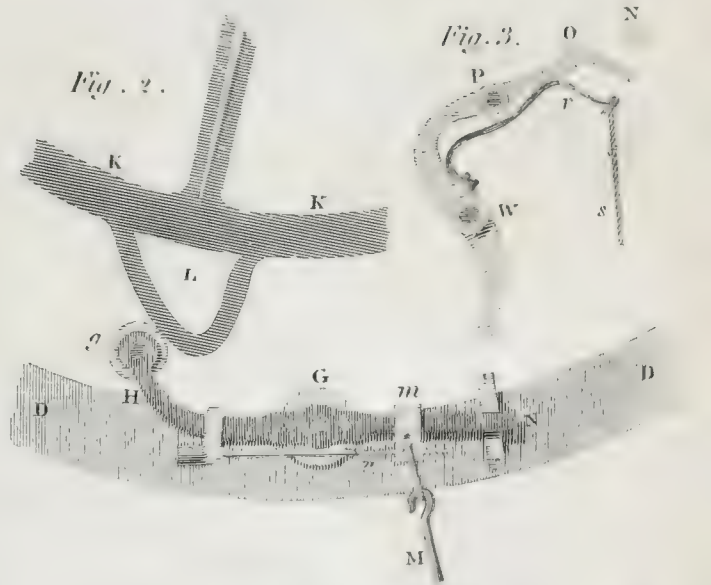
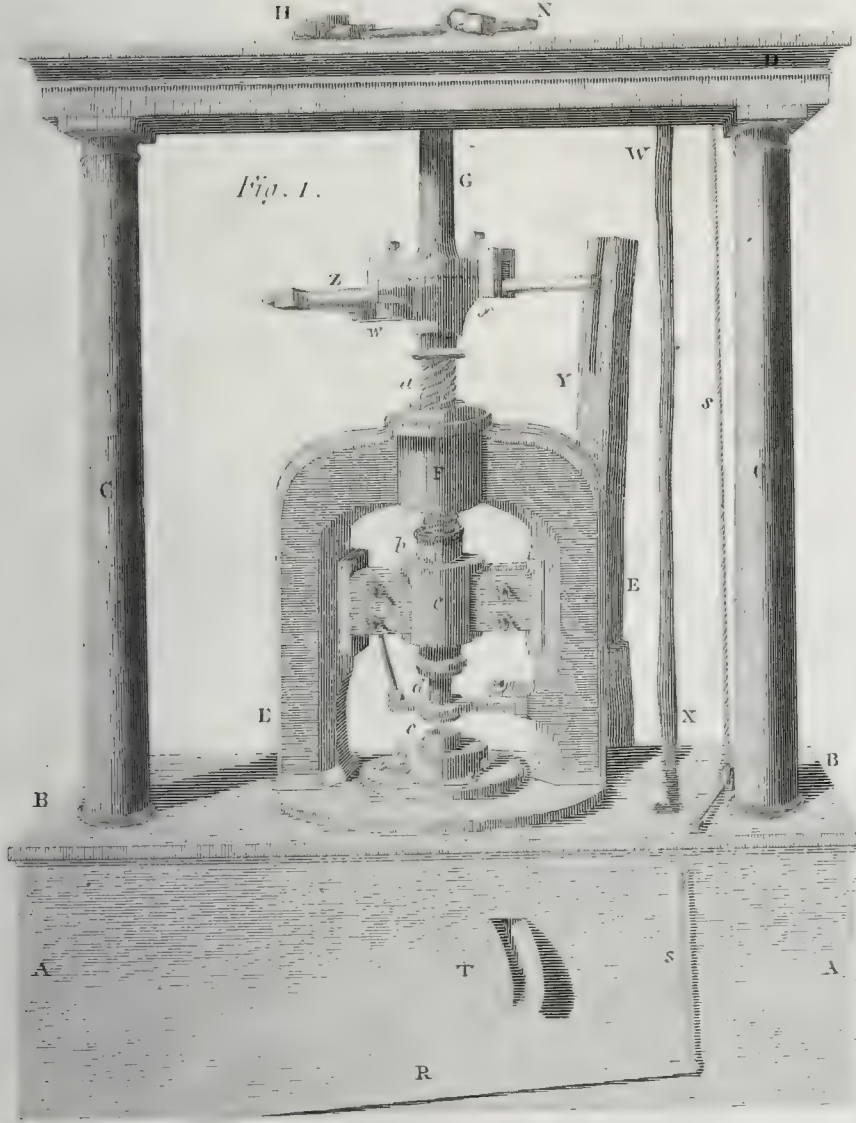
Fig. 8.



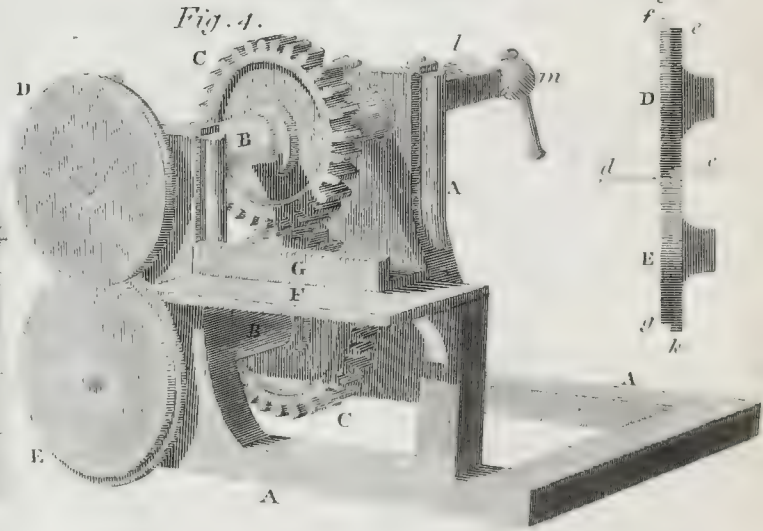


Machinery used in the Royal Mint.

Cutting out Machine.



Circular Shears.



Old Coining Apparatus used in the Tower.



Coining Press.





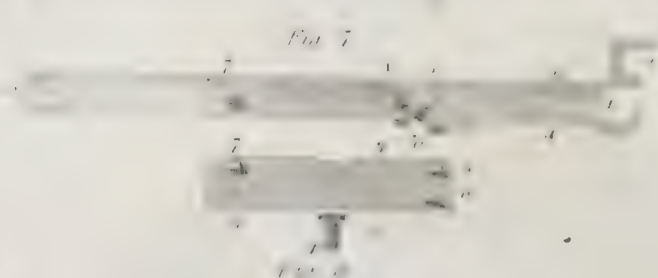
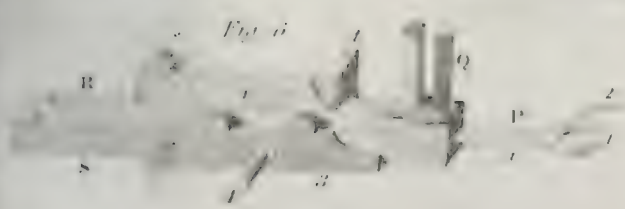
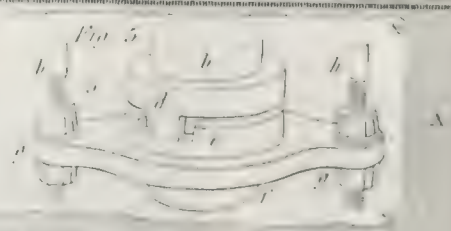
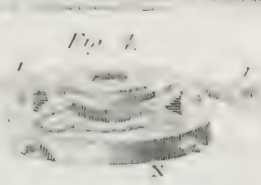
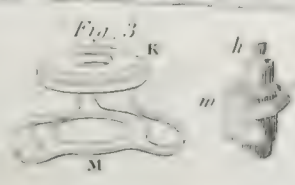
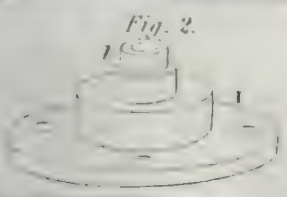
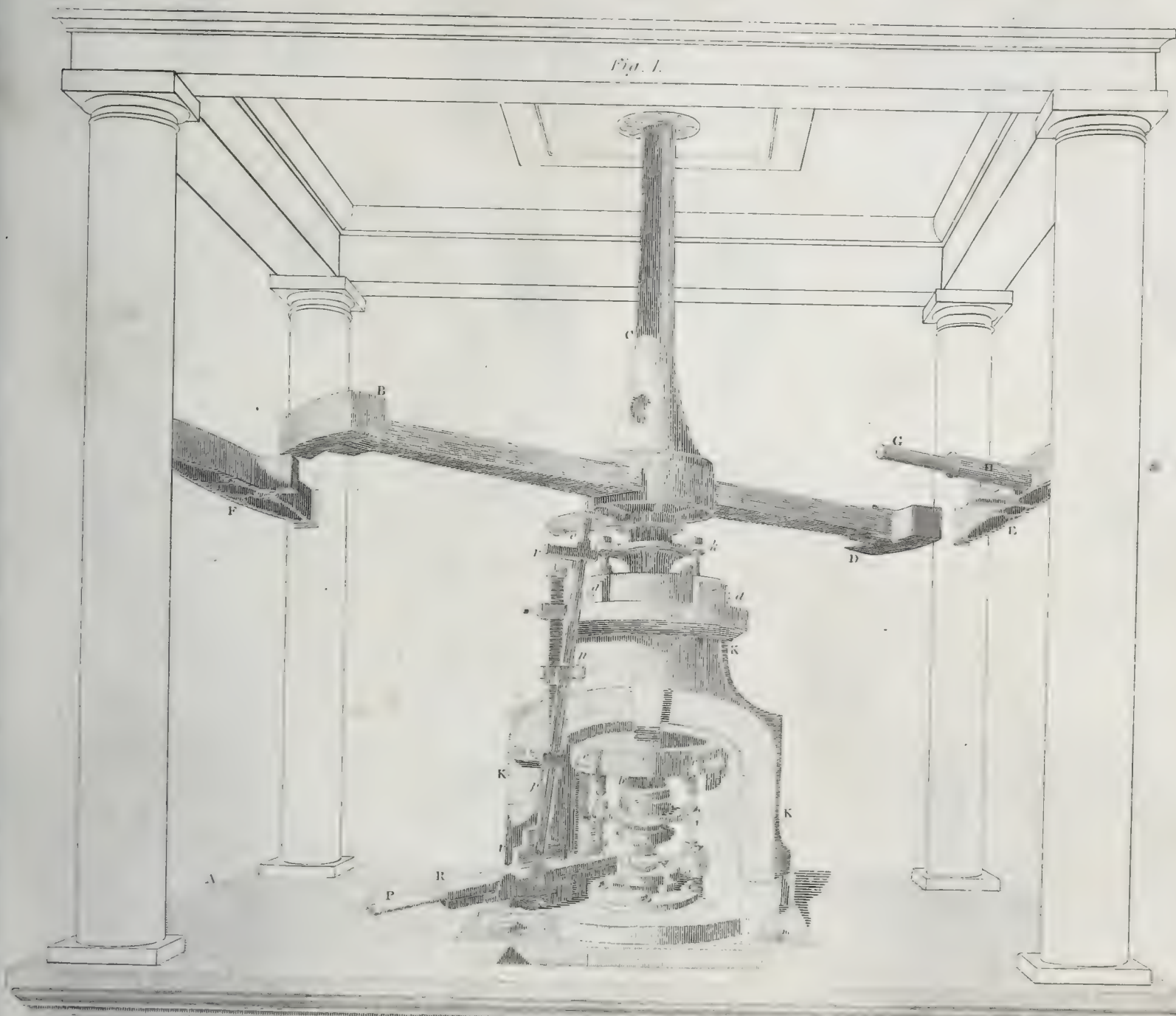






Fig. 1.

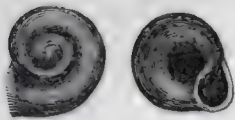
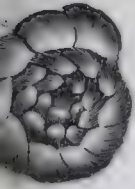


Fig. 2.



Fig. 3.



Fig. 4.



Fig. 5.

Fig. 6.



Fig. 7.

Fig. 8.



Fig. 10.



Fig. 12.



Fig. 15.



Fig. 17.

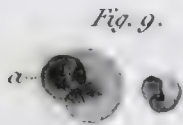


Fig. 9.

Fig. 11.



Fig. 13.

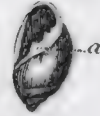


Fig. 14.

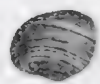


Fig. 16.

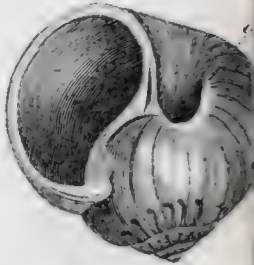


Fig. 18.

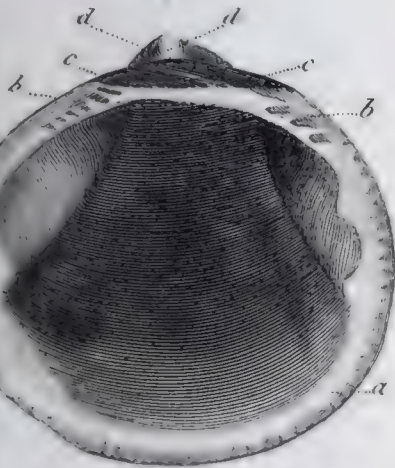


Fig. 19.

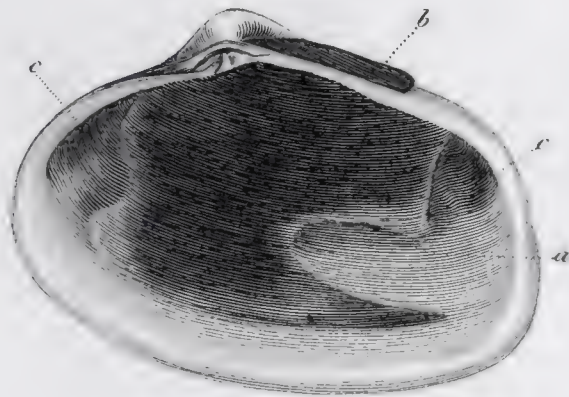


Fig. 20.

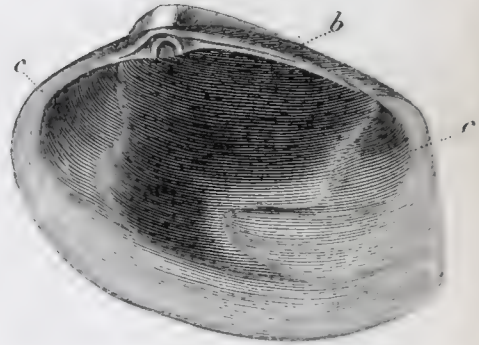


Fig. 22.

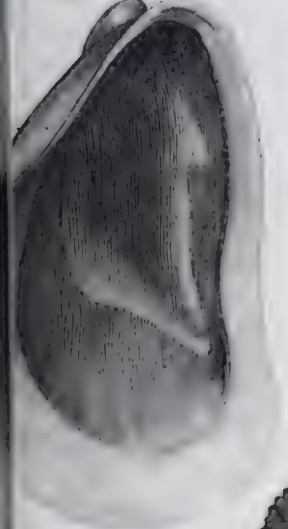


Fig. 21.



Fig. 23.

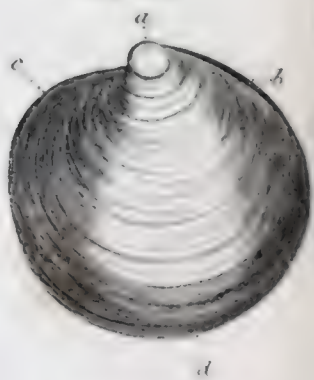


Fig. 23.

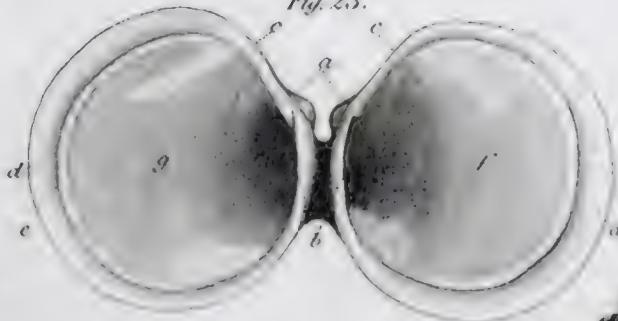


Fig. 25.

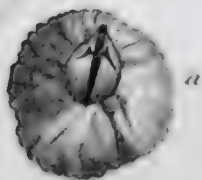


Fig. 24.





Fig. 2.



Fig. 1.

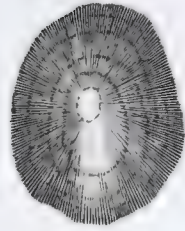
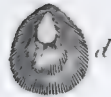


Fig. 3.



Fig. 4.

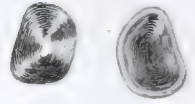


Fig. 5.

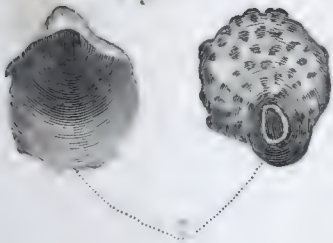


Fig. 6.

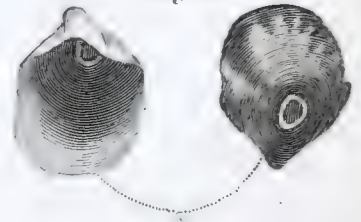


Fig. 7.



Fig. 9.



Fig. 11.



Fig. 12.



Fig. 13.

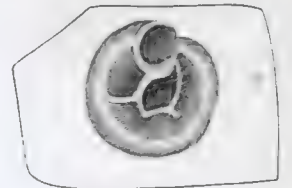


Fig. 8.

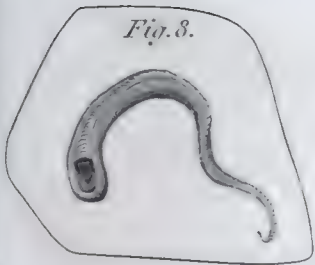


Fig. 10.



MYTILUS ANATINUS.

Fig. 14.

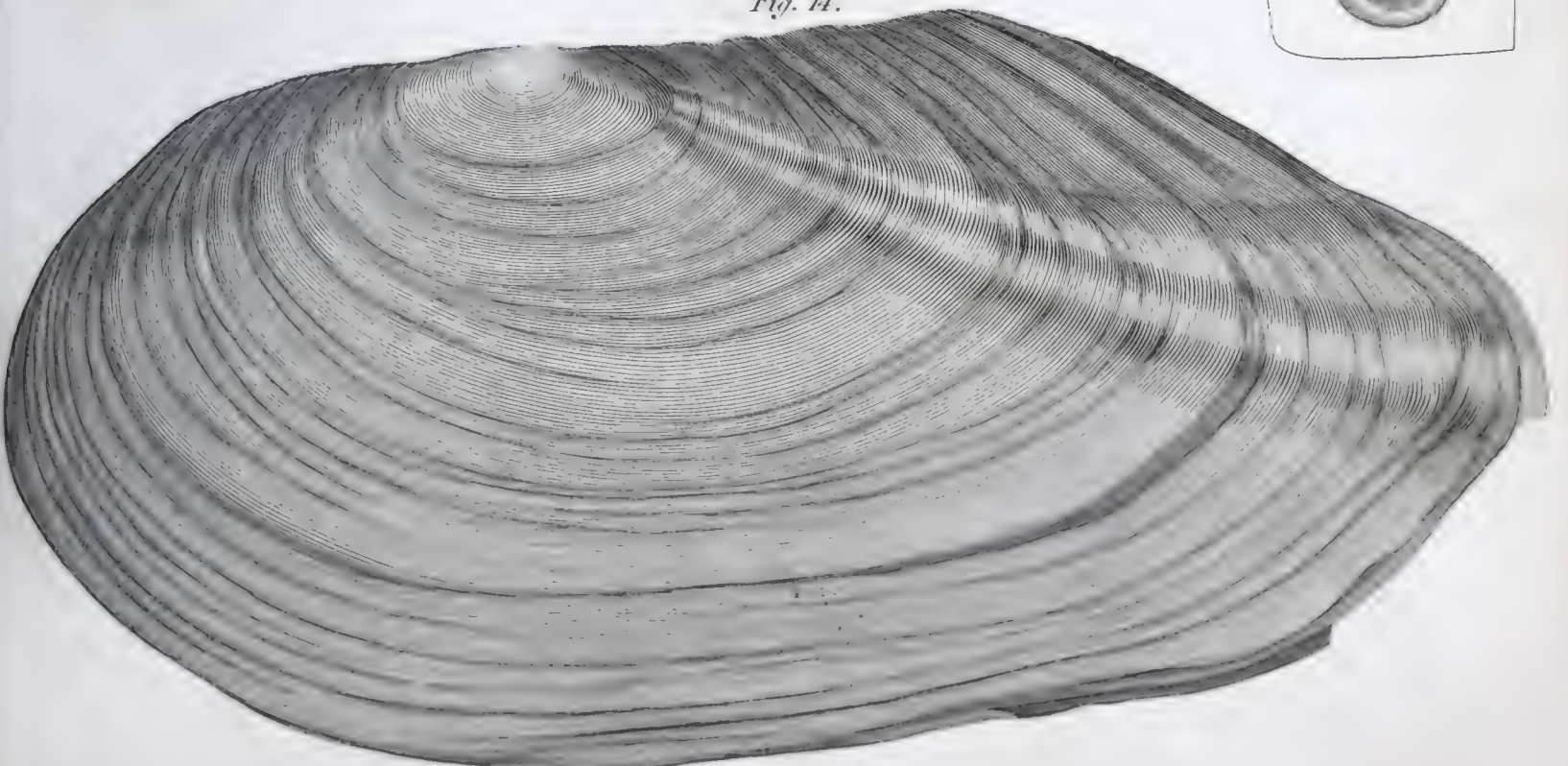




Fig. 1.



Fig. 2.



Fig. 3.

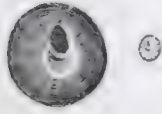


Fig. 4.

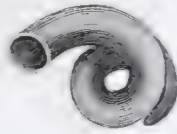


Fig. 5.



Fig. 6.



Fig. 7.



Fig. 8.



Fig. 9.



Fig. 10.



Fig. 11.



Fig. 14.

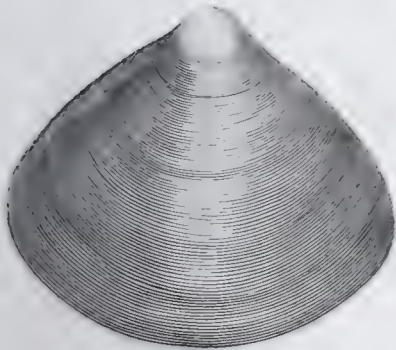


Fig. 12.



Fig. 13.

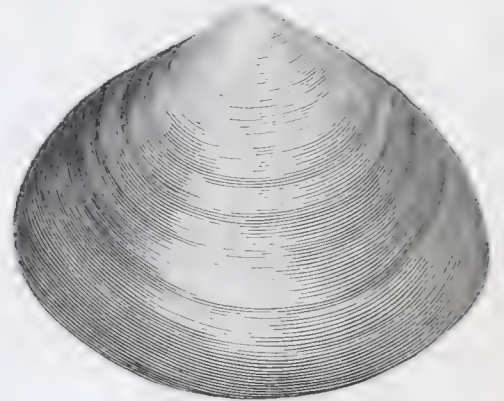
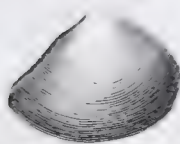


Fig. 15.



MYTILUS CYGNEUS

Fig. 16.

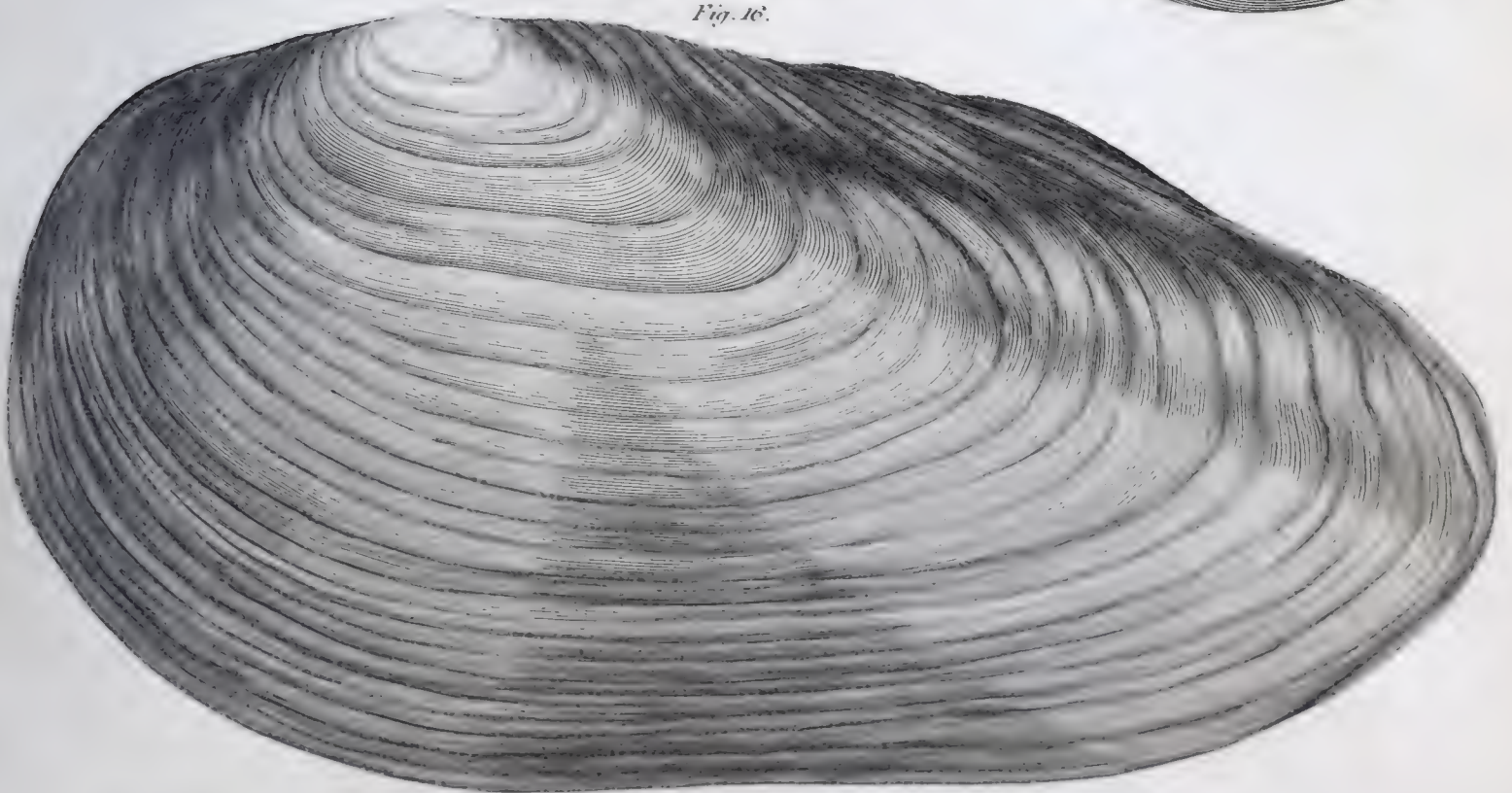




Fig. 1.

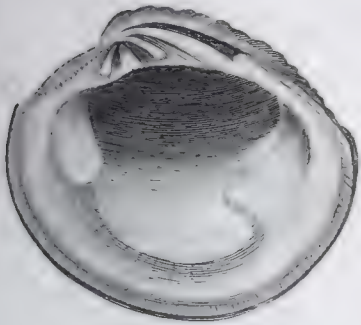


Fig. 1.



Fig. 1.

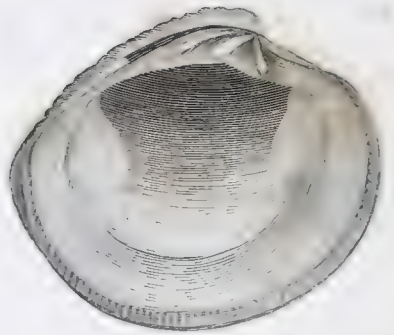


Fig. 1.

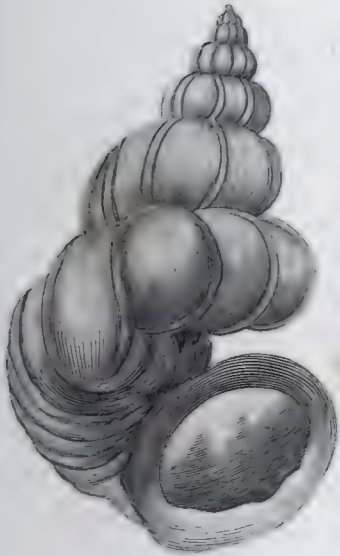


Fig. 2.



Fig. 2.



Fig. 2.

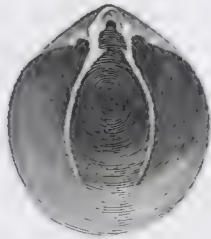


Fig. 5.

MYTILUS AVONENSIS.

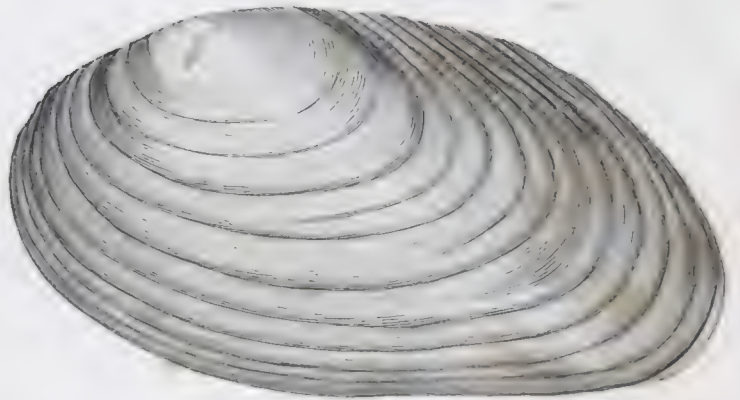


Fig. 3.











Fig 68



Fig 69

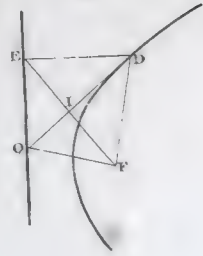


Fig. 70.

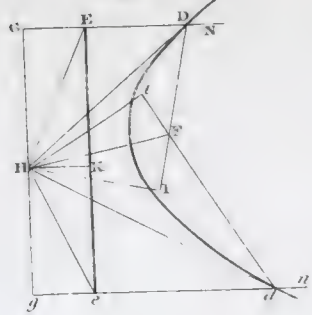


Fig. 71.

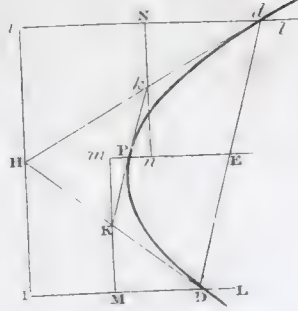


Fig. 72

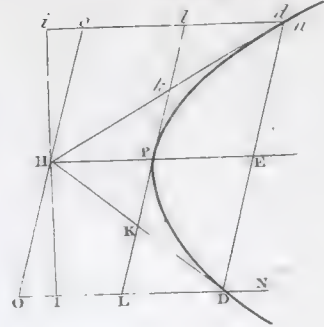


Fig. 73

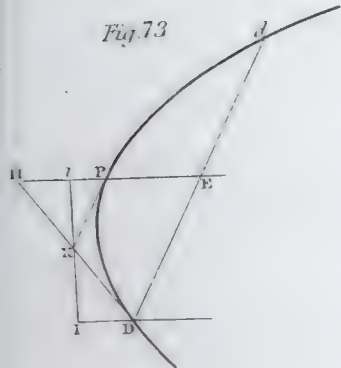


Fig. 74.

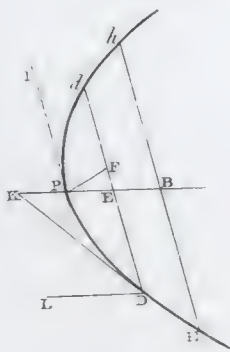


Fig. 75

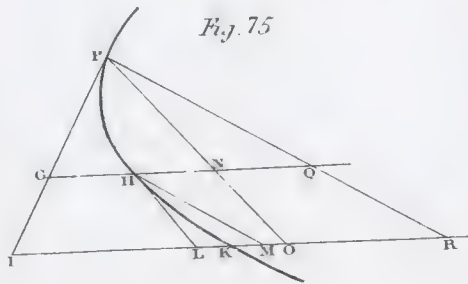


Fig. 77.

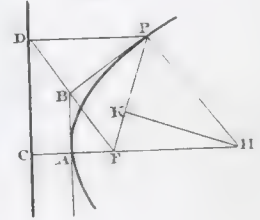


Fig. 76.

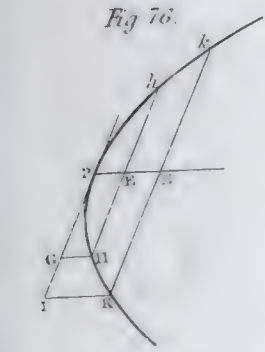


Fig. 78.

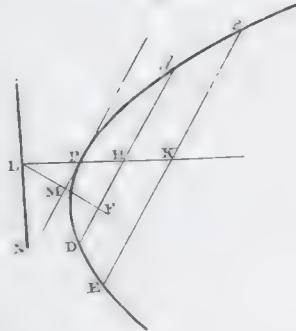


Fig. 79.

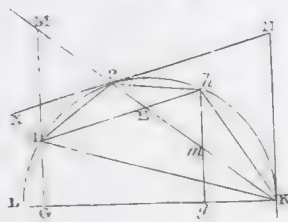


Fig. 80

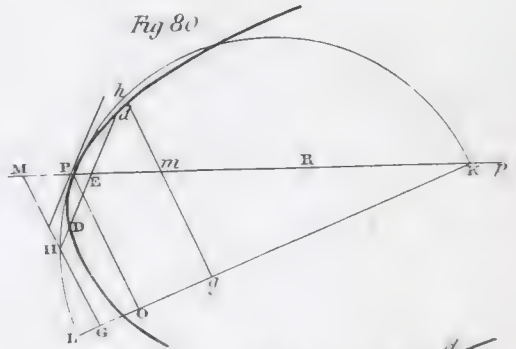


Fig. 82.

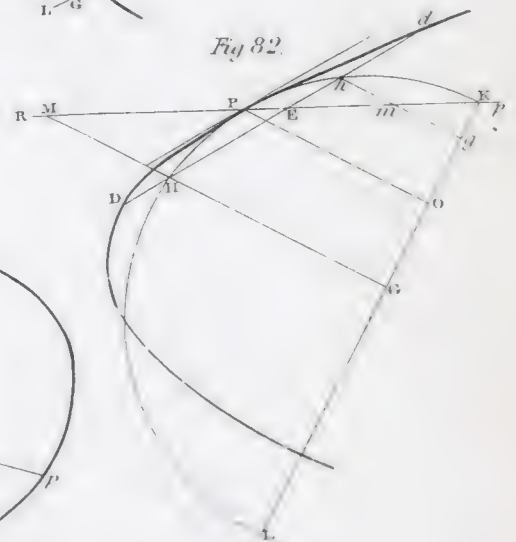


Fig. 81.

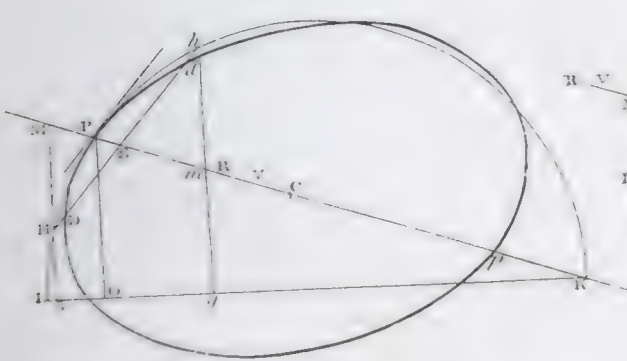


Fig. 83

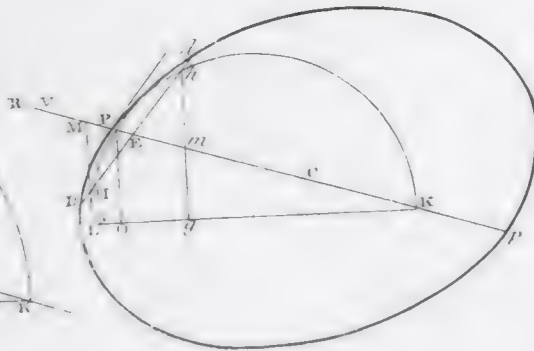


Fig. 87

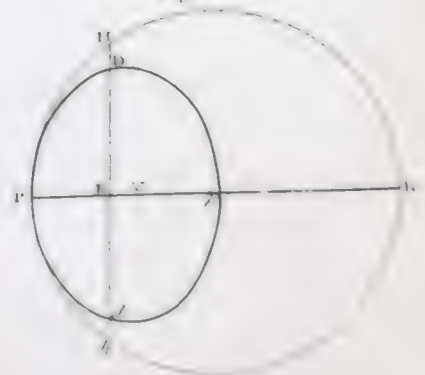


Fig. 84

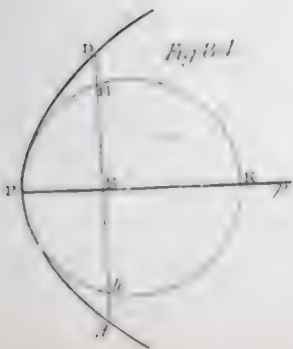


Fig. 85.

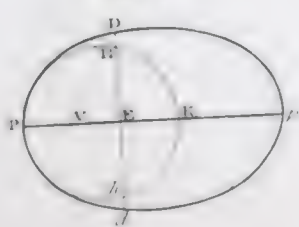
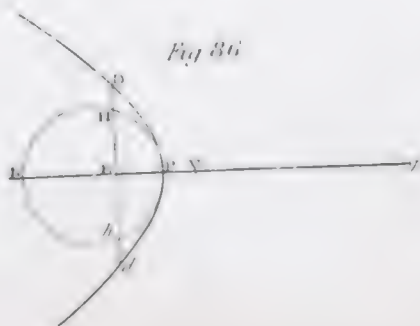


Fig. 86









COTTON.

Fig. 1. N<sup>o</sup> 1.

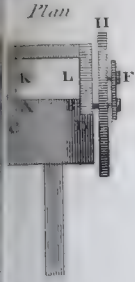


Fig. 1. N<sup>o</sup> 2.  
Profile Section

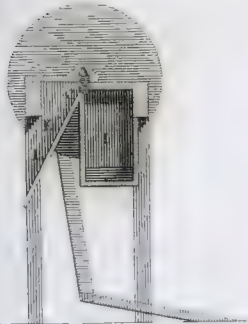


Fig. 1. N<sup>o</sup> 3.  
Front Section

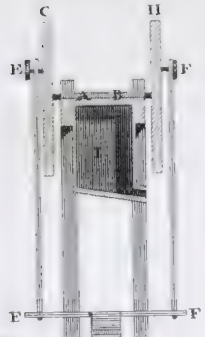


Fig. 2. N<sup>o</sup> 1.  
Profile Section

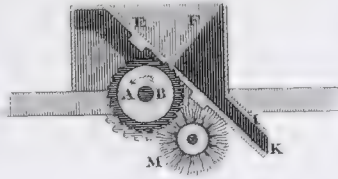


Fig. 2. N<sup>o</sup> 2.  
Plan

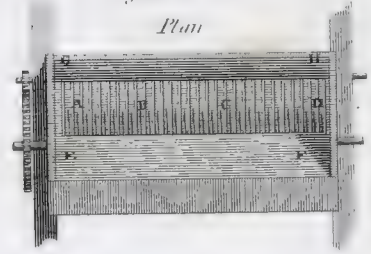


Fig. 3. N<sup>o</sup> 1.  
View Supposing the gearing  
was likewise the end bounding

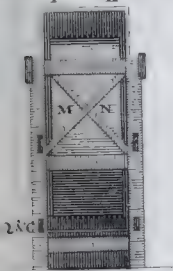


Fig. 3. N<sup>o</sup> 2.  
Side View

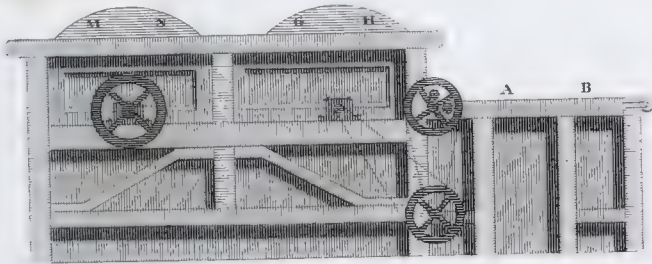


Fig. 2. N<sup>o</sup> 3.  
Elevation

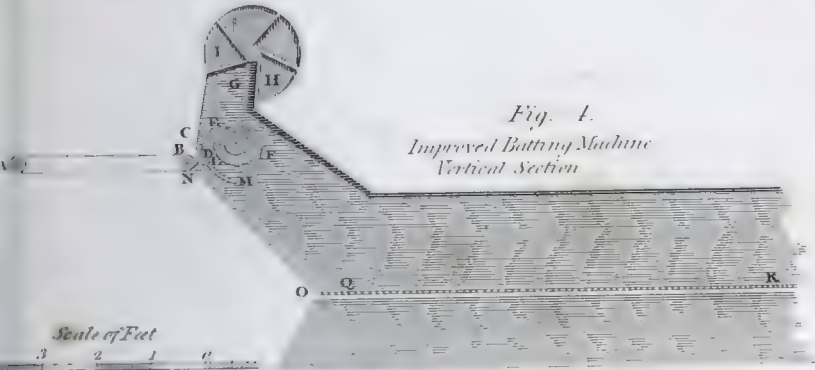
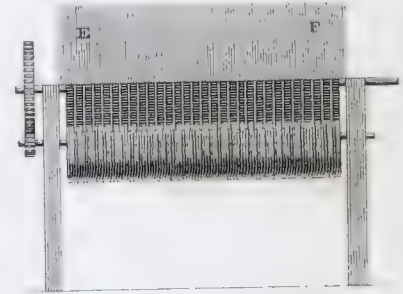
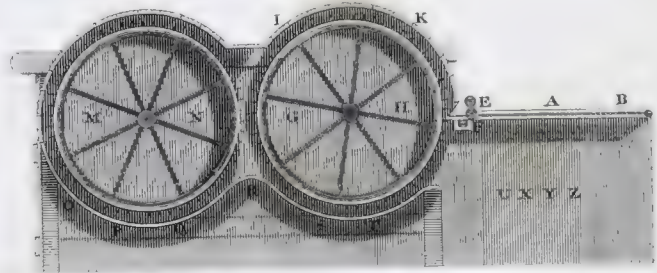


Fig. 4.  
Improved Bathing Machine  
Vertical Section

Fig. 3. N<sup>o</sup> 3.  
Elevated Section



NEW DIAGONAL MULE

Fig. 5.  
Horizontal Plan

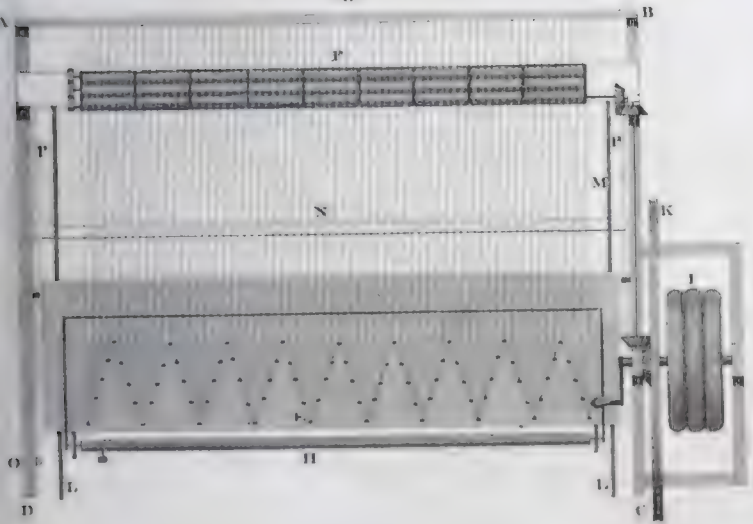
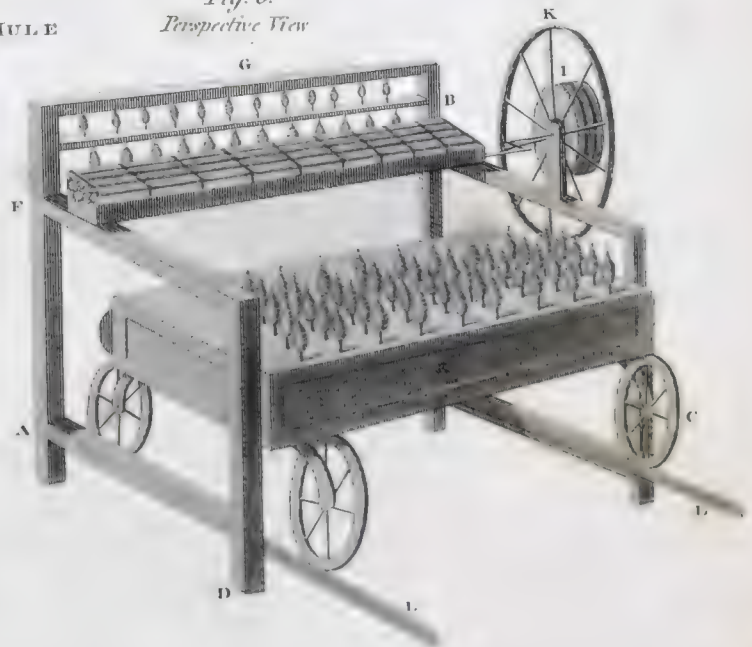


Fig. 6.  
Perspective View







VERTICAL SECTION.  
Fig. 3.

CARDING.

VERTICAL SECTION.  
Fig. 5.

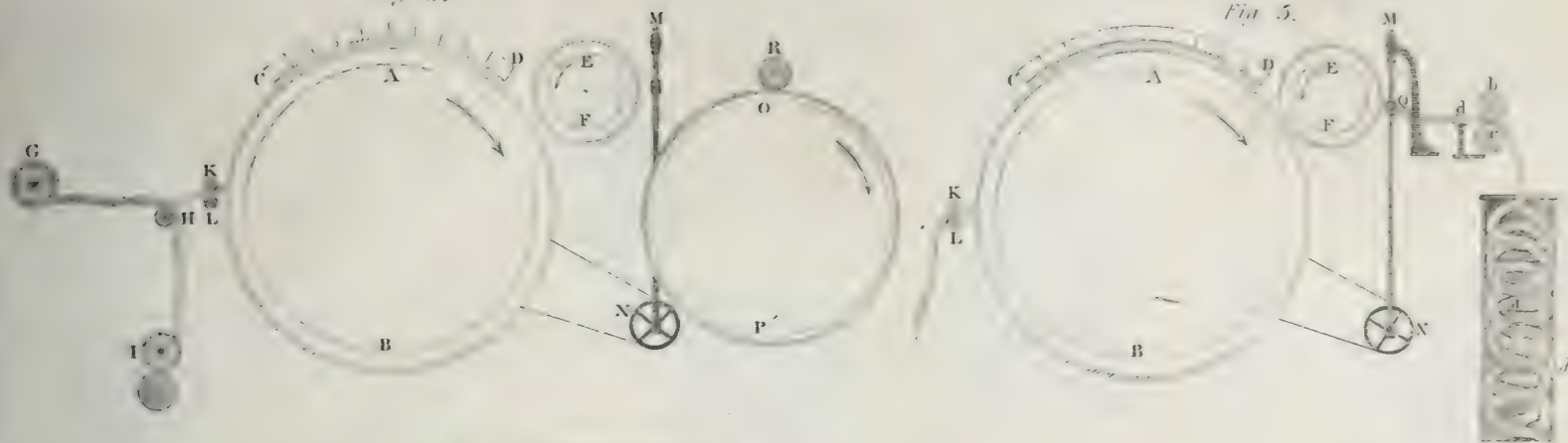


Fig. 1.

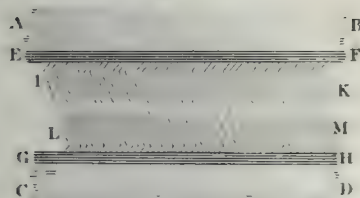
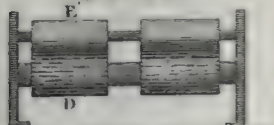


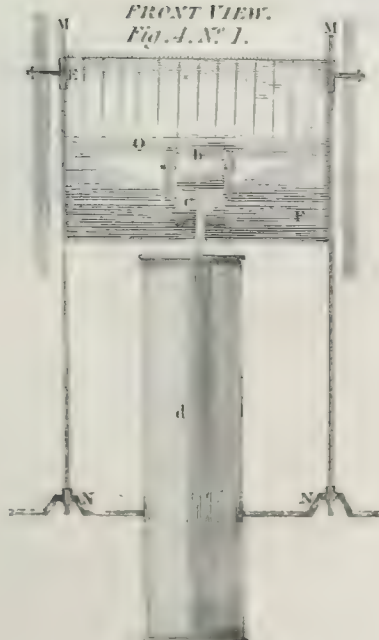
Fig. 2.



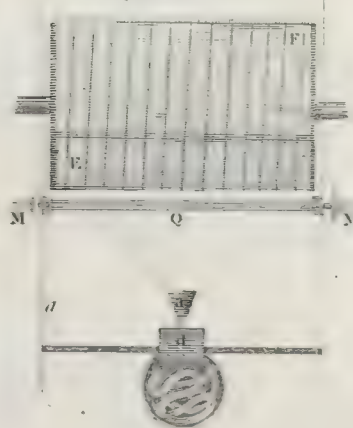
FRONT ELEVATION.  
Fig. 3. N° 2.



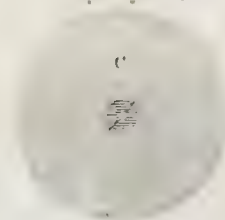
FRONT VIEW.  
Fig. 4. N° 1.



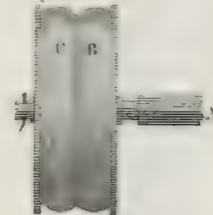
PLAN.  
Fig. 4. N° 2.



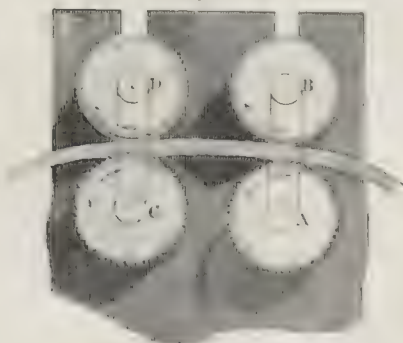
ELEVATION.  
Fig. 6. N° 1.



PROFILE.  
Fig. 6. N° 2.



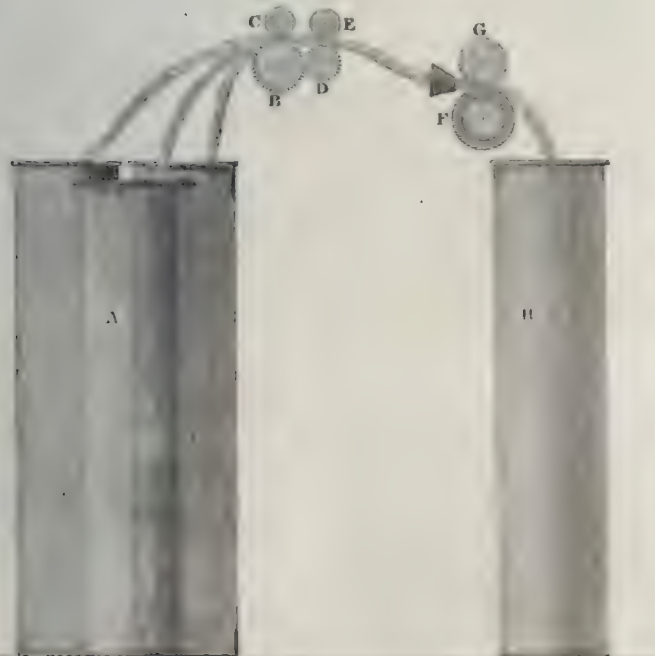
VERTICAL SECTION.  
Fig. 7.



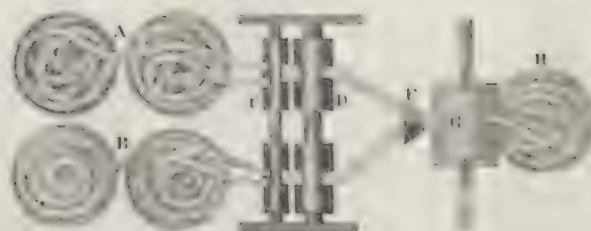
SECTION.  
Fig. 6. N° 3.



PROFILE.  
Fig. 8. N° 1.



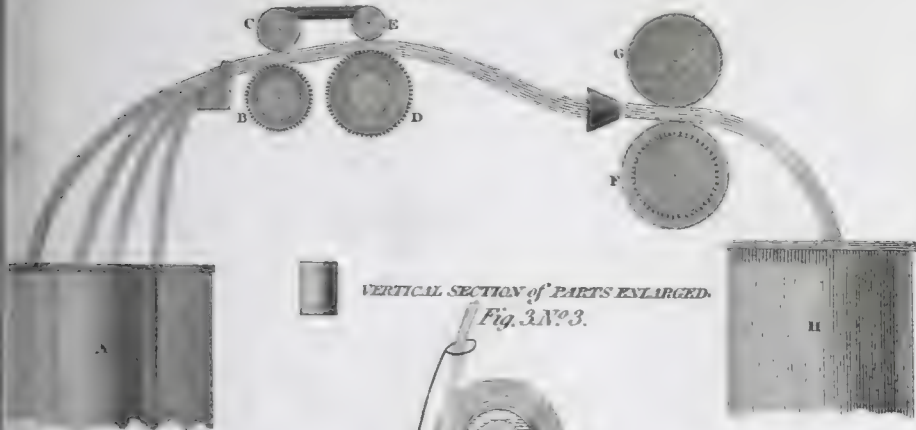
PLAN.  
Fig. 8. N° 2.





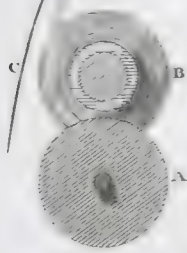
ENDVIEW of ROLLERS on a LARGER SCALE.

Fig. 1.



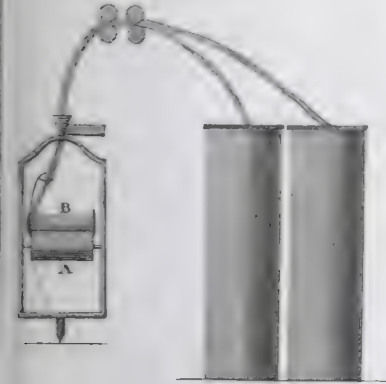
VERTICAL SECTION of PARTS ENLARGED.

Fig. 3. N° 3.



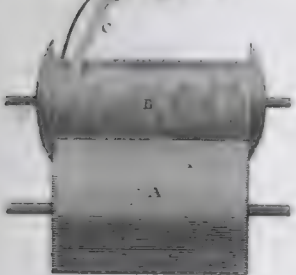
ELEVATION of JACK.

Fig. 3. N° 1.



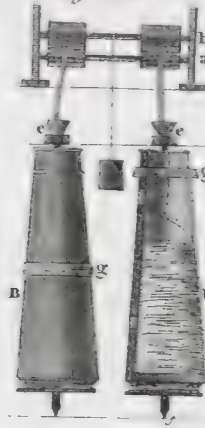
ELEVATION of PARTS ENLARGED.

Fig. 3. N° 2.



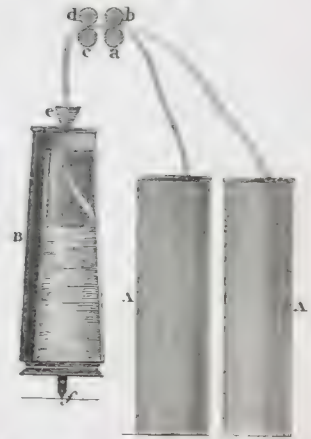
ELEVATION.

Fig. 2. N° 1.



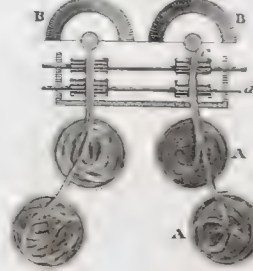
PROFILE.

Fig. 2. N° 2.



PLAN.

Fig. 2. N° 3.



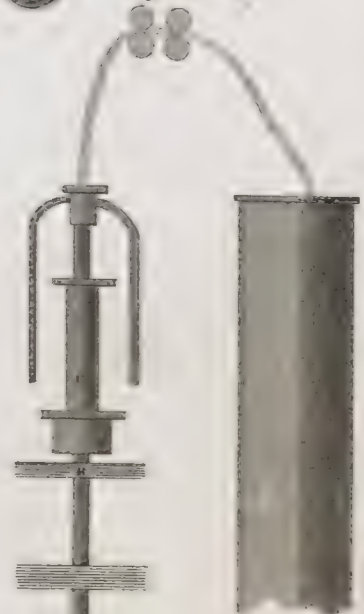
PROFILE.

Fig. 5.



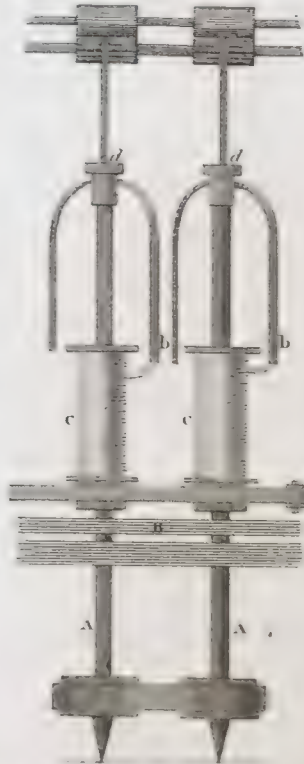
PROFILE.

Fig. 4. N° 2.



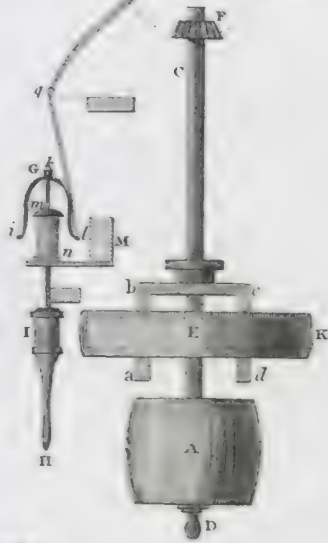
ELEVATION.

Fig. 4. N° 1.



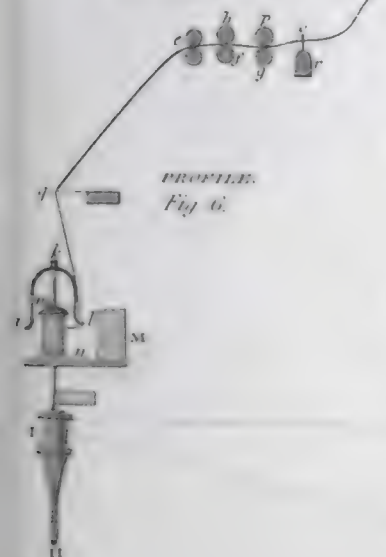
PROFILE.

Fig. 7.



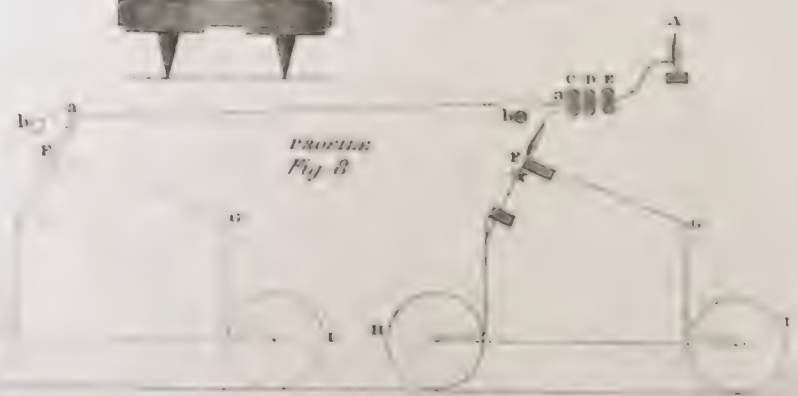
PROFILE.

Fig. 6.



PROFILE.

Fig. 8.





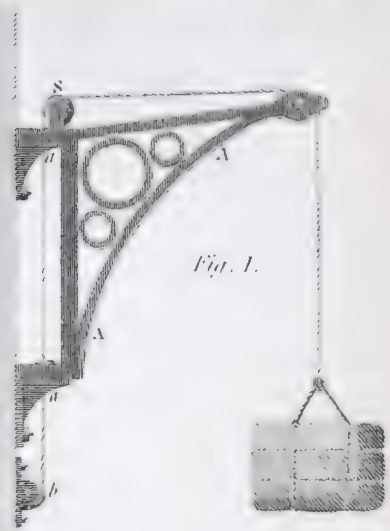
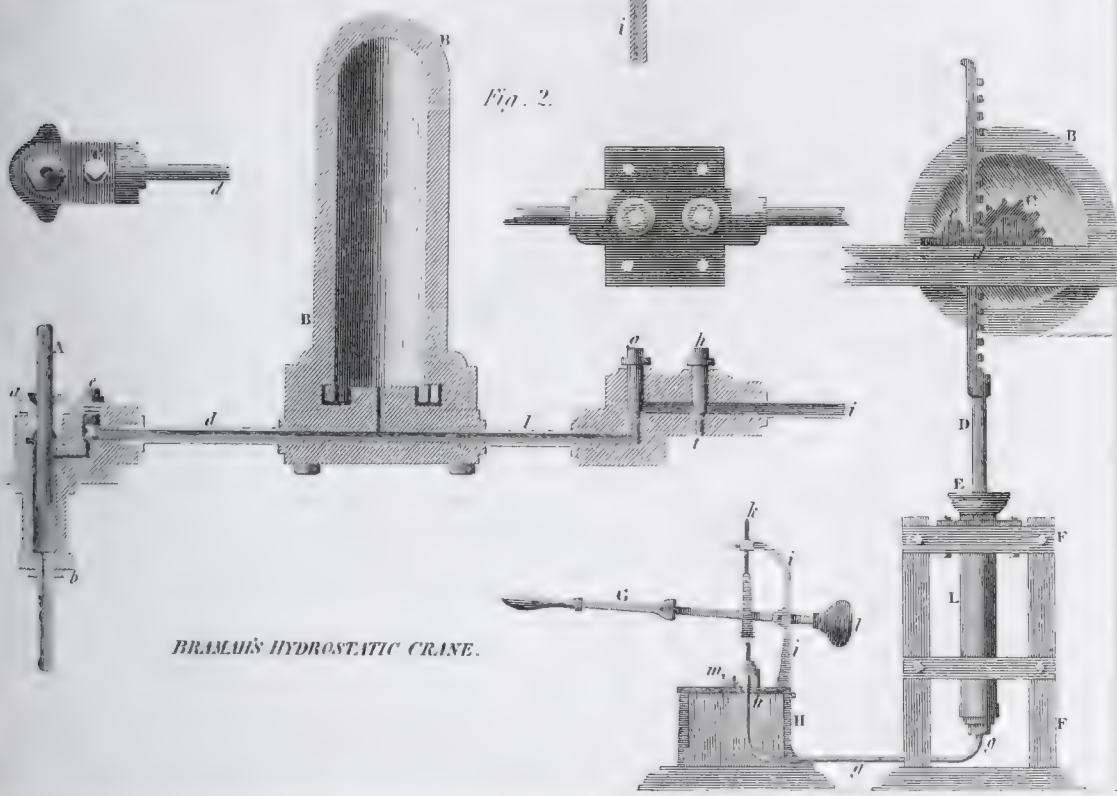
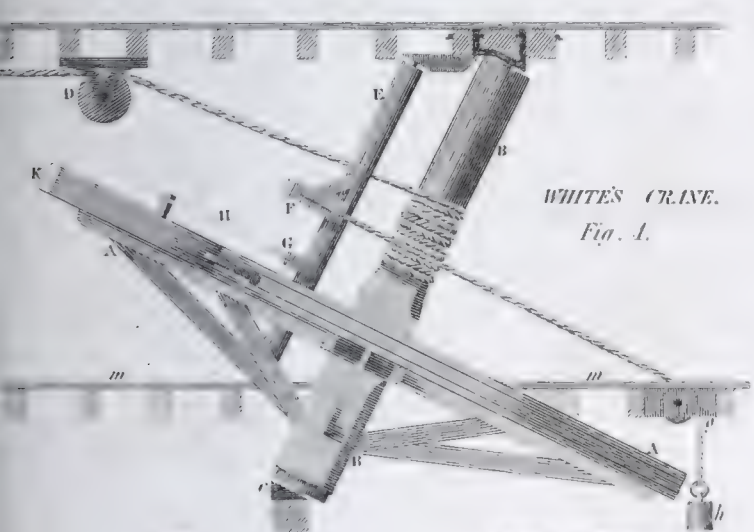


Fig. 2.

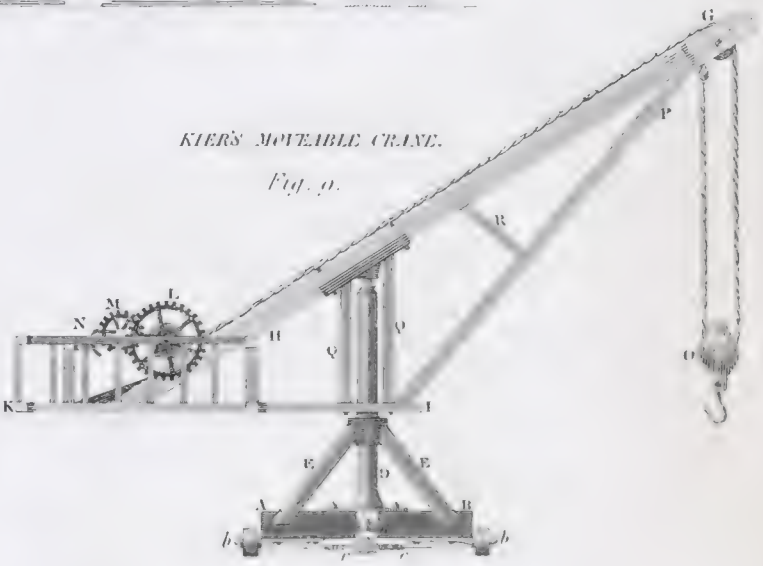


BRAMHUS' HYDROSTATIC CRANE.

SAFETY VALVE.  
Fig. 3.



WHITE'S CRANE.  
Fig. 4.



KIER'S MOVEABLE CRANE.  
Fig. 5.

HARDIE'S LOWERING CYLINDER.

GILPIN'S CRANE.

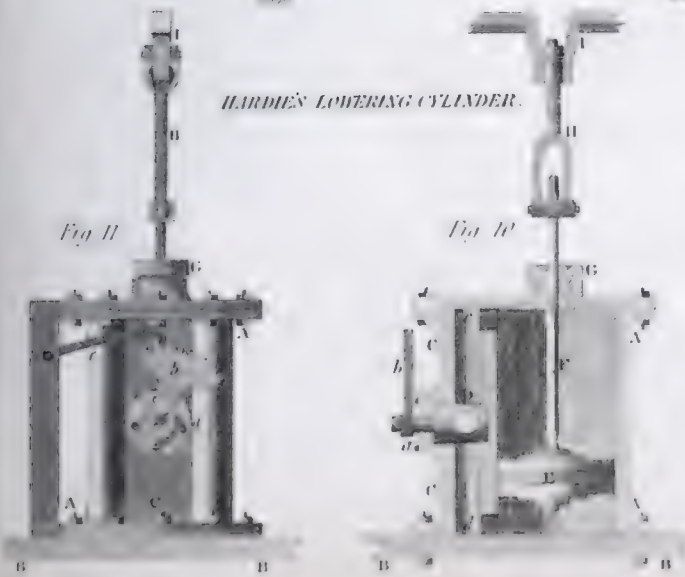


Fig. 6

Fig. 7

Fig. 8.

Fig. 7.

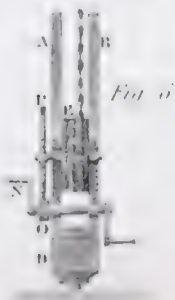


Fig. 8

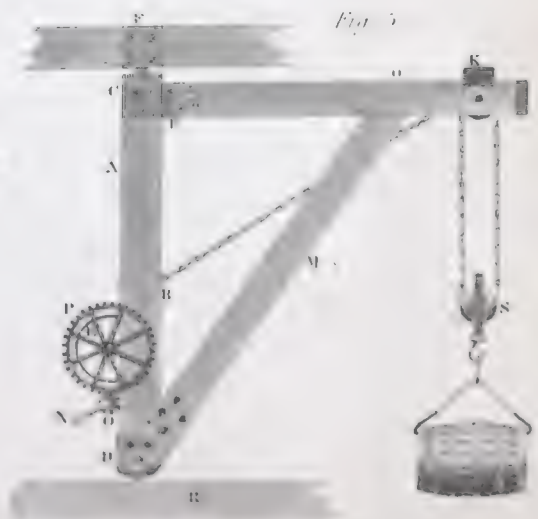


Fig. 9



CRANES.

PLATE CCXVI.

CAST IRON CRANES.

Fig. 1.

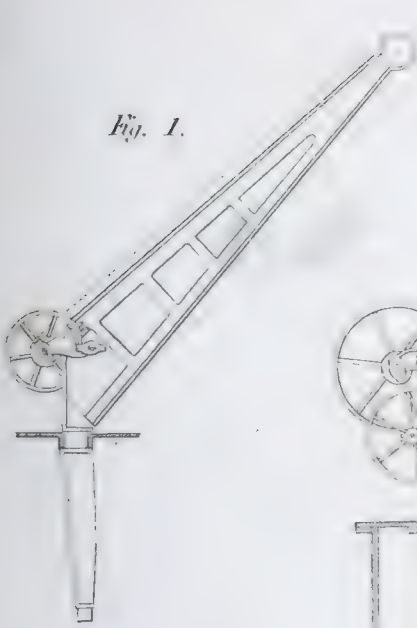


Fig. 2.

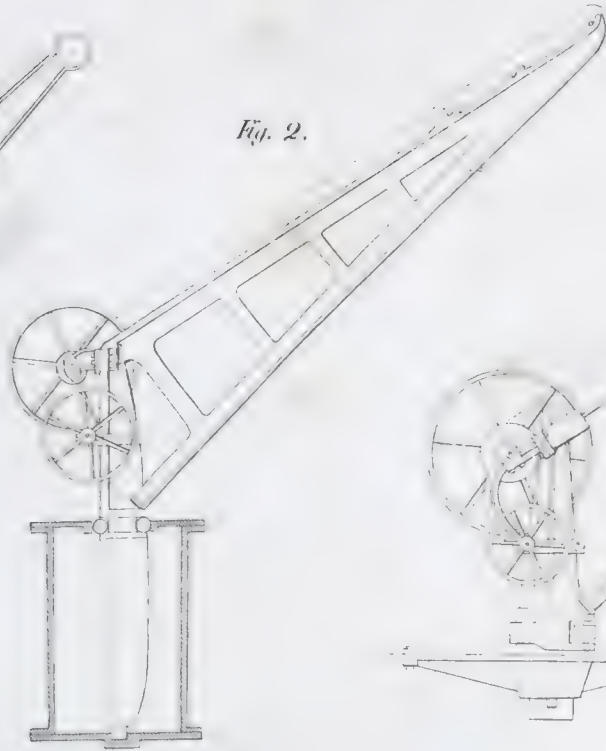


Fig. 3.

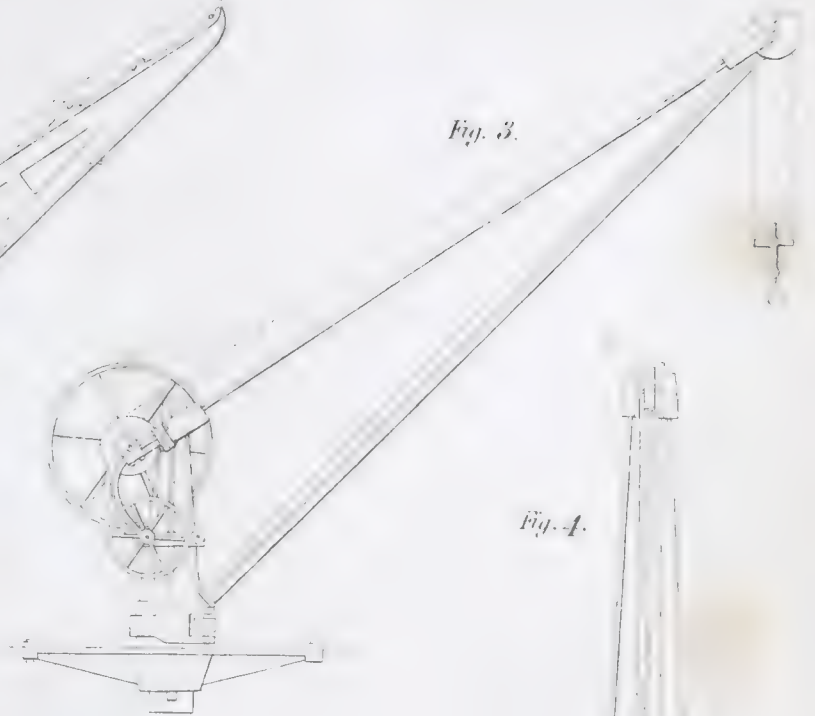


Fig. 4.



Fig. 5.

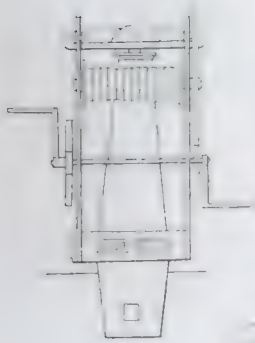


Fig. 6.

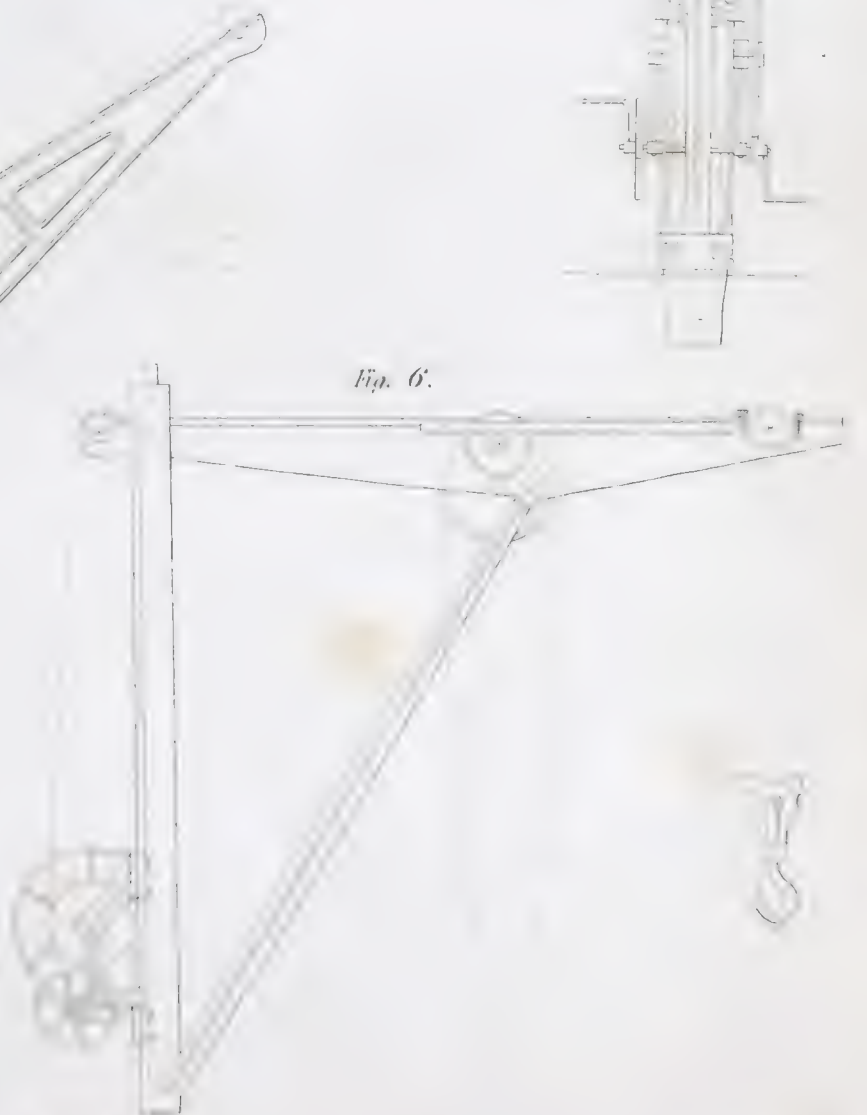
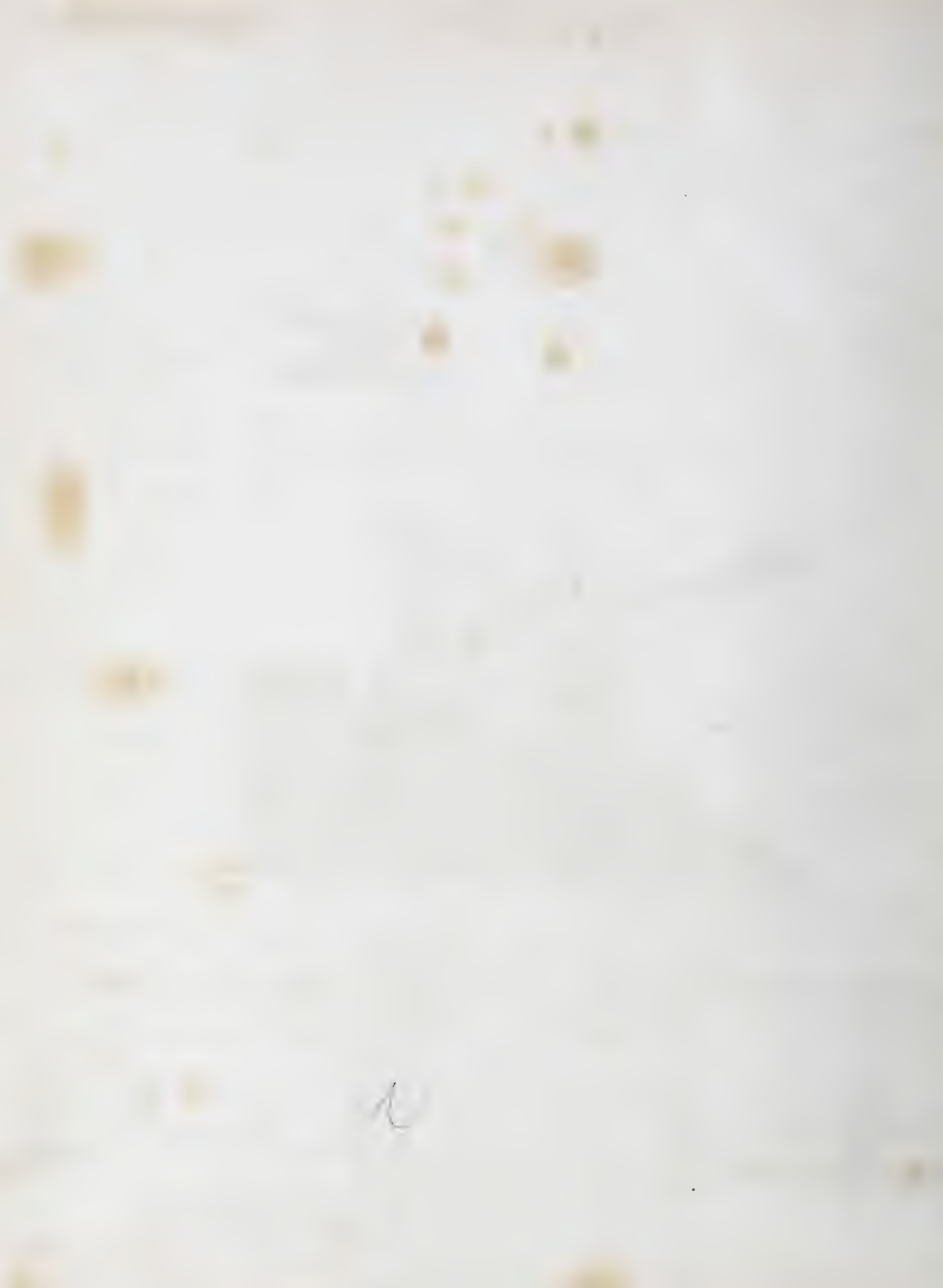


Fig. 7.



Scale of Feet

0 1 2 3 4 5 6 7 8 9 10 11 12 13 14 15 16 17





# CRANES.

# PLATE CCXVII.

Scale of Feet for Fig. 1, 2 & 3.

Fig. 1.

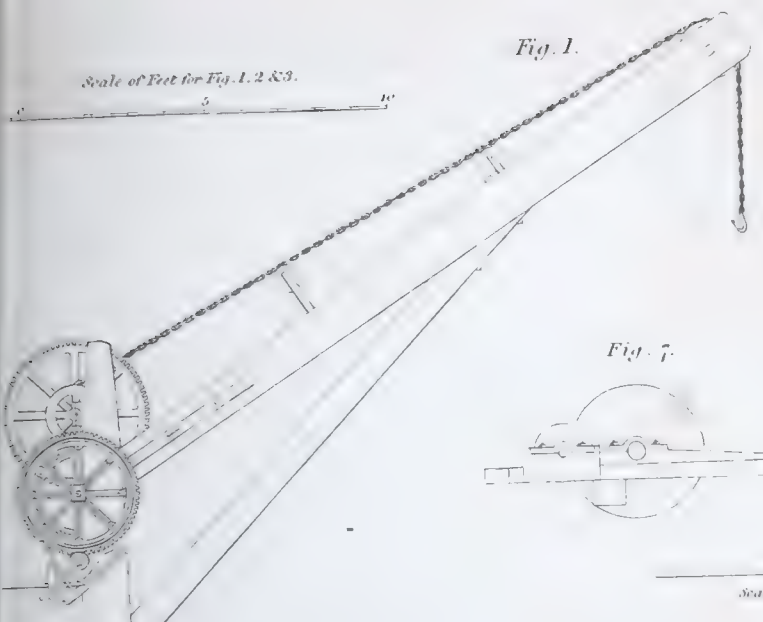


Fig. 3.

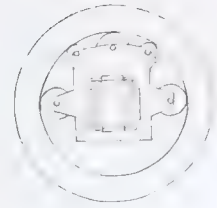


Fig. 2.

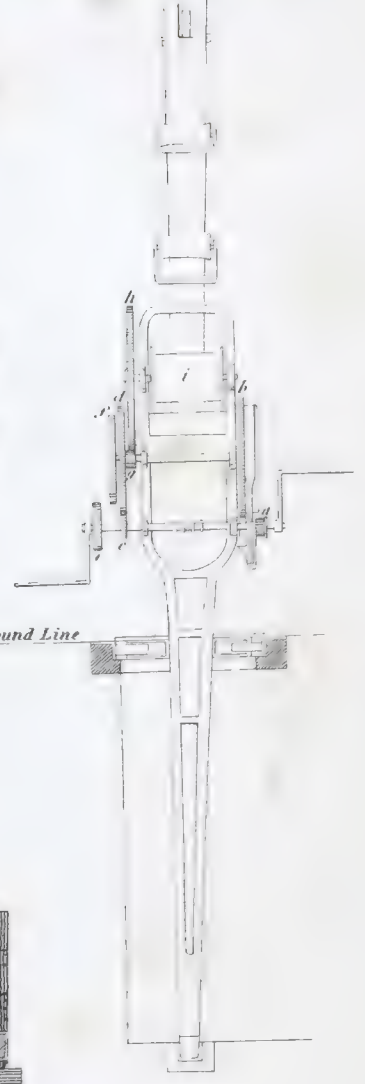


Fig. 7.

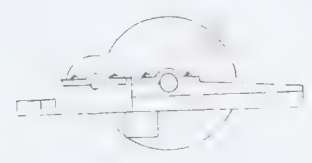
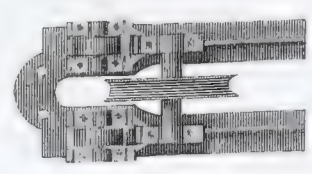


Fig. 8.



Scale of Feet for Fig. 7 & 8.

Fig. 5.

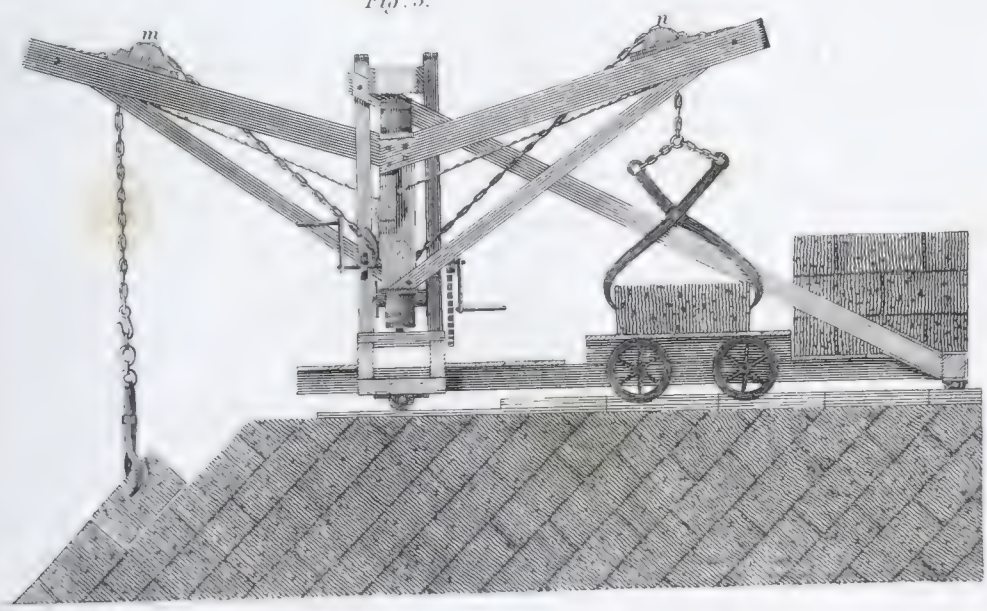


Fig. 4.

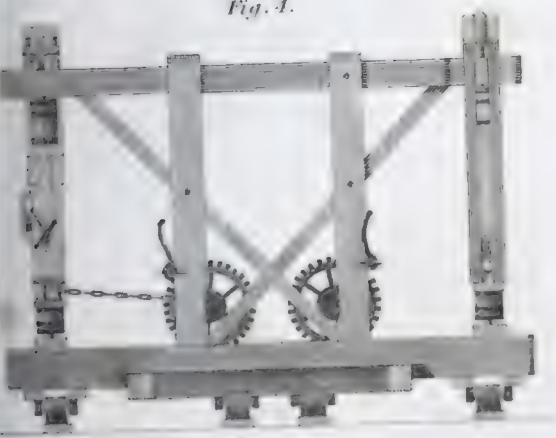
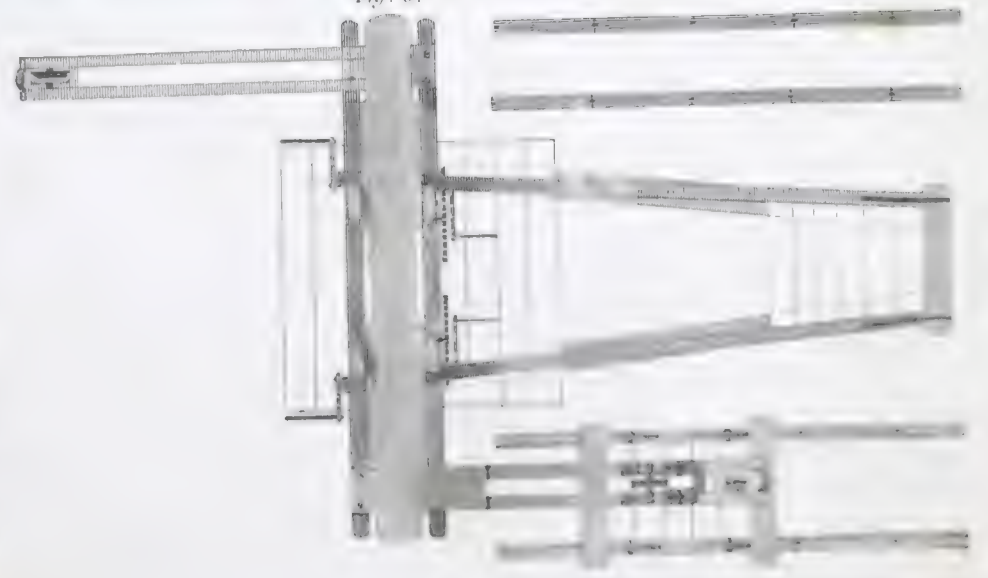


Fig. 6.

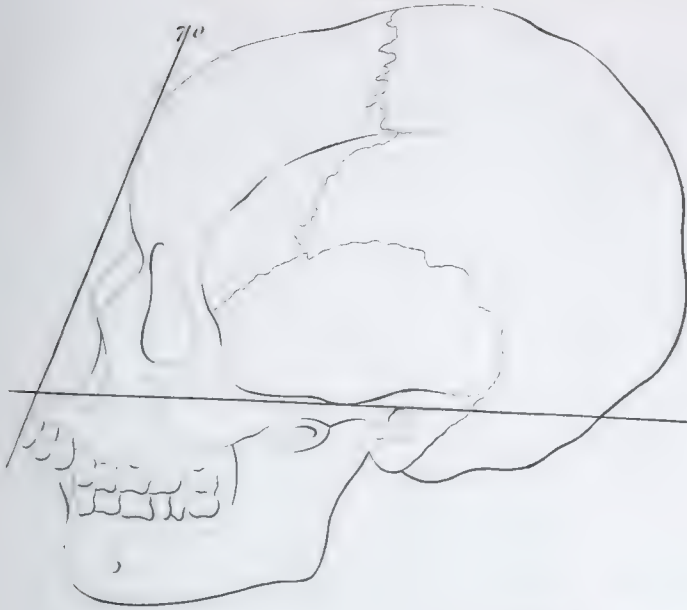


Scale of Feet for Fig. 4, 5 & 6.



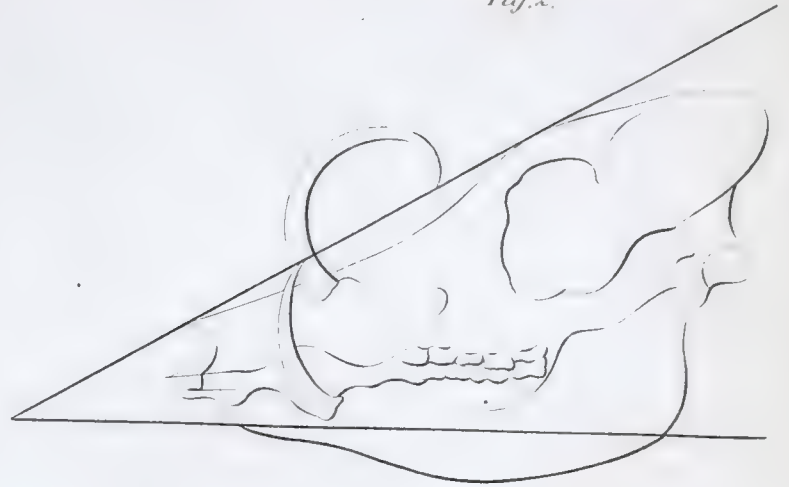
CAMPERS FACIAL LINE.

Fig. 1.



BASI FACIAL LINE.

Fig. 2.



NORMA VERTICALIS OF BLUMENBACH.

Fig. 3.

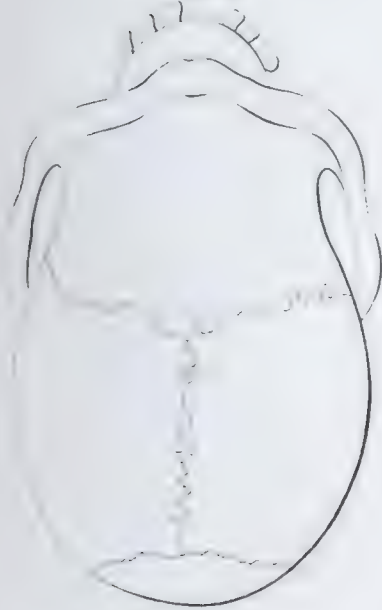
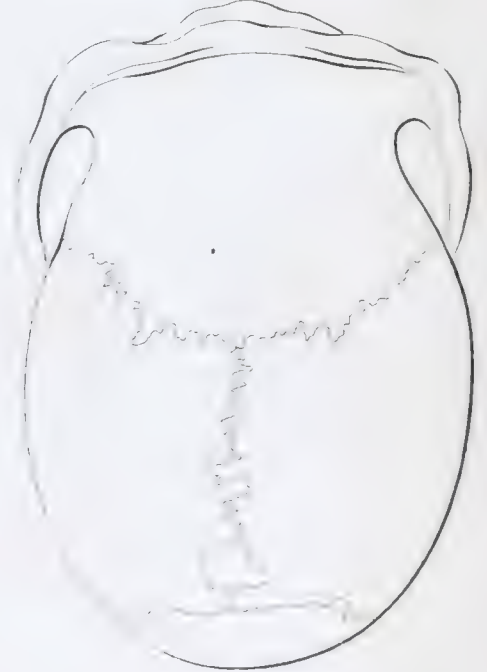


Fig. 4.

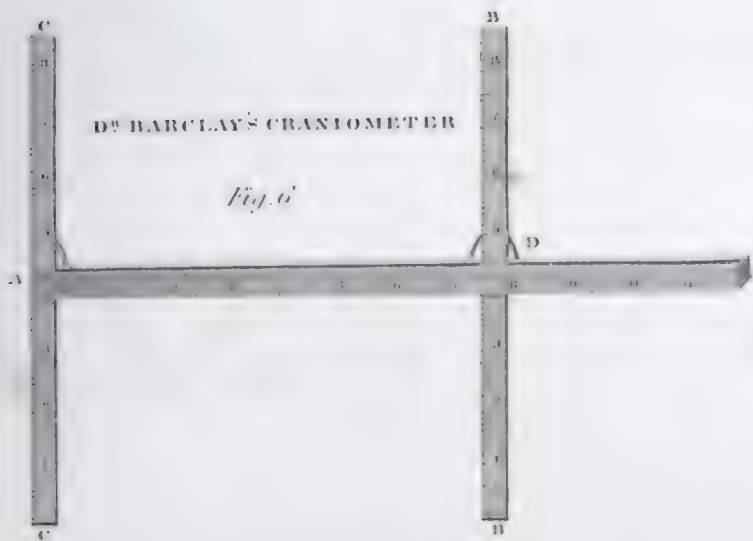


Fig. 5.



D<sup>r</sup> BARCLAY'S CRANIOMETER

Fig. 6.



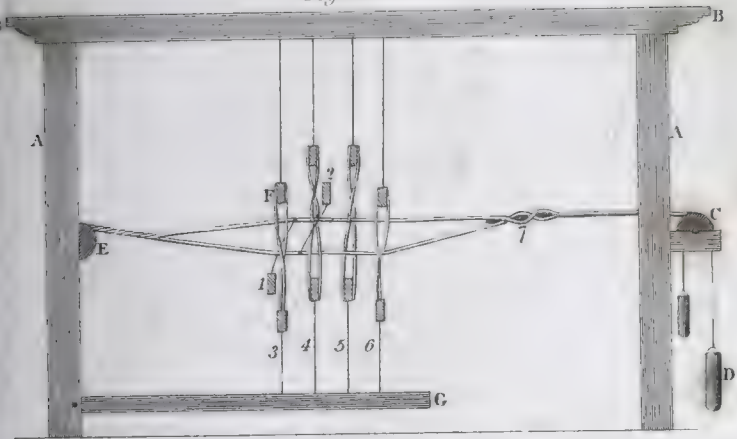
JELEACH'S CRANIOMETER

Fig. 7.

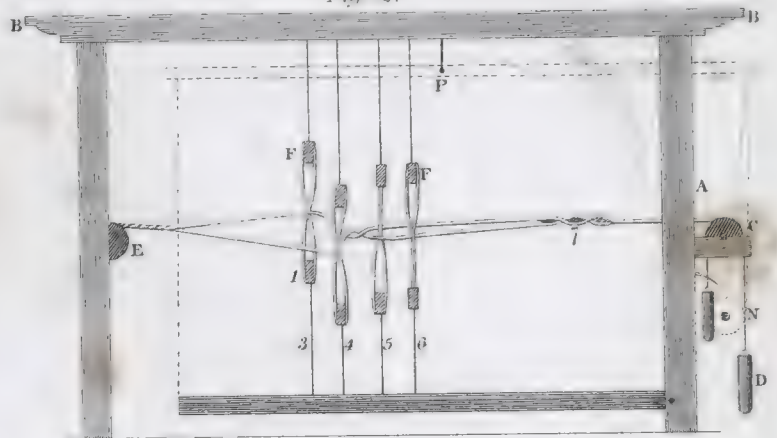




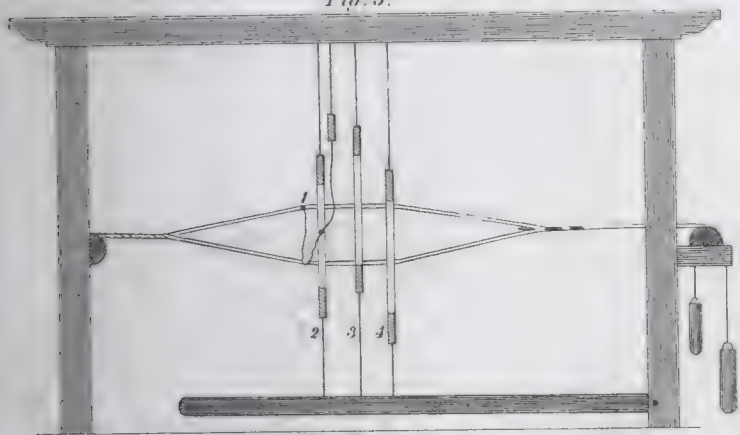
OPEN LINAU.  
Fig. 1.



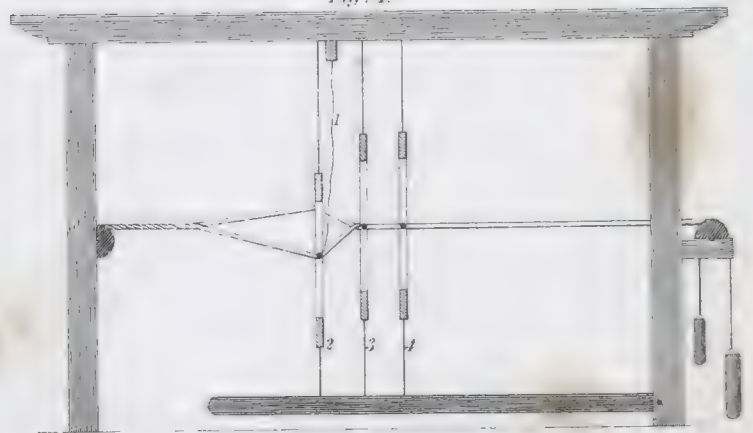
CROSSED LINAU.  
Fig. 2.



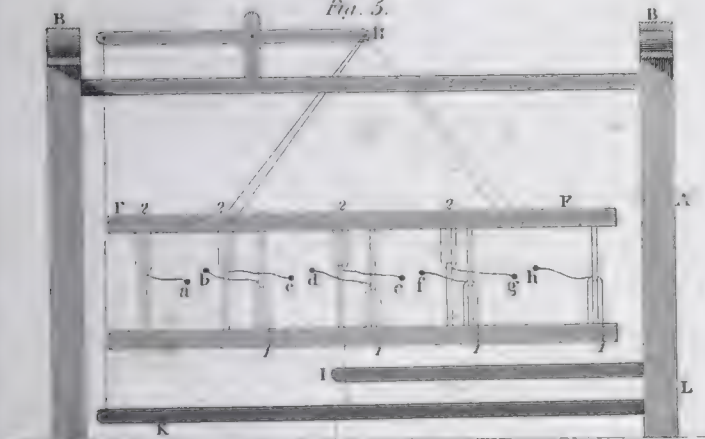
OPEN CATGUT.  
Fig. 3.



CROSSED CATGUT.  
Fig. 4.



WHIP NET OPEN.  
Fig. 5.



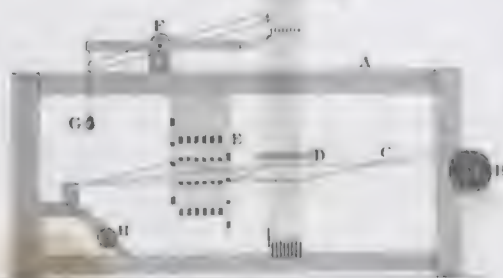
WHIP NET CROSSED.  
Fig. 6.



PATENT NET OPEN.  
Fig. 7.



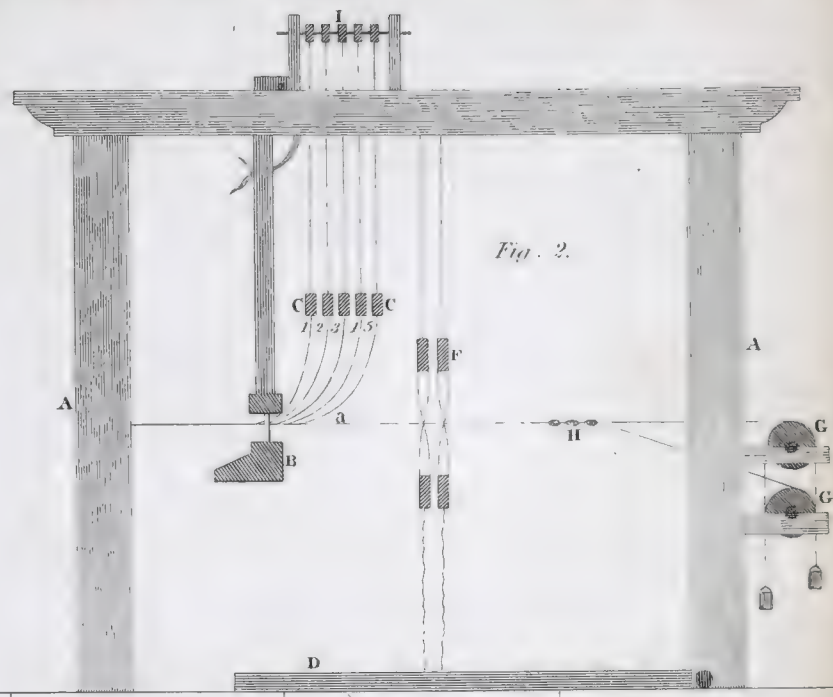
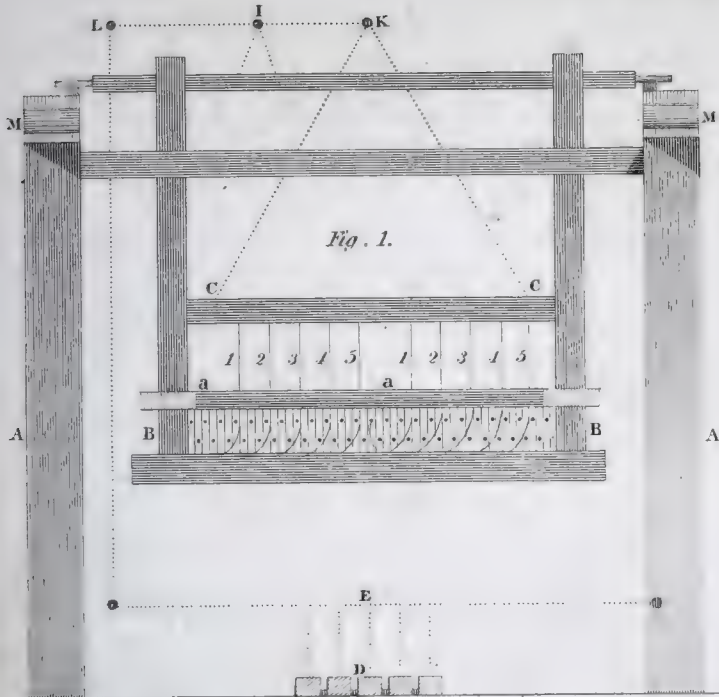
PATENT DRAW LOOM.  
Fig. 8.



PATENT NET CROSSED & FINISHED.  
Fig. 9.







OPEN STATE. <i>Fig. 3.</i> <i>All Shafts Down.</i>	1 <sup>st</sup> CROSSING.	2 <sup>d</sup> CROSSING.	3 <sup>d</sup> CROSSING.	4 <sup>th</sup> CROSSING.	5 <sup>th</sup> CROSSING.
<i>D</i>	<i>D</i>	<i>D</i>	<i>D</i>	<i>D</i>	<i>D</i>
<i>1 2 3 4 5</i>	<i>1<sup>st</sup> Shaft Raised.</i> <i>1 2 3 4 5</i>	<i>2<sup>d</sup> Shaft Raised.</i> <i>1 2 3 4 5</i>	<i>3<sup>d</sup> Shaft Raised.</i> <i>1 2 3 4 5</i>	<i>4<sup>th</sup> Shaft Raised.</i> <i>1 2 3 4 5</i>	<i>5<sup>th</sup> Shaft Raised.</i> <i>1 2 3 4 5</i>
<i>C</i>	<i>C</i>	<i>C</i>	<i>C</i>	<i>C</i>	<i>C</i>
<i>A</i>	<i>A</i>	<i>A</i>	<i>A</i>	<i>A</i>	<i>A</i>
<i>B</i>	<i>B</i>	<i>B</i>	<i>B</i>	<i>B</i>	<i>B</i>

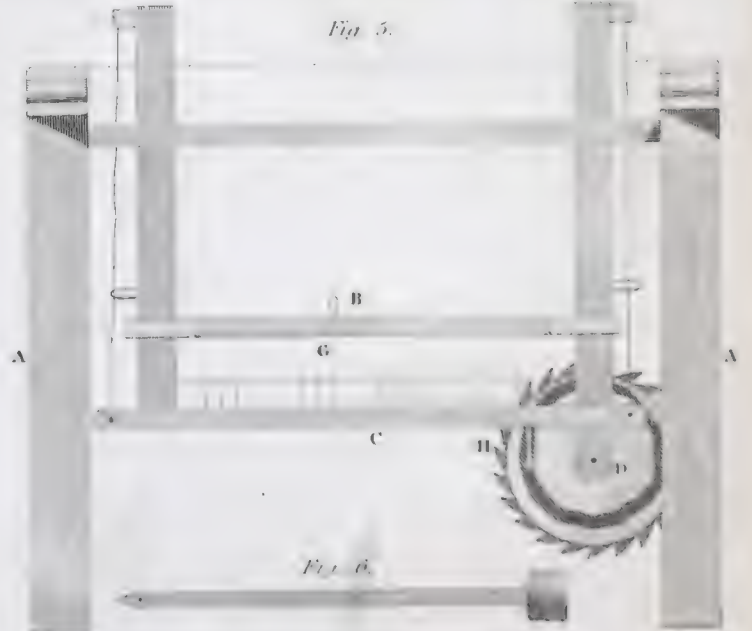
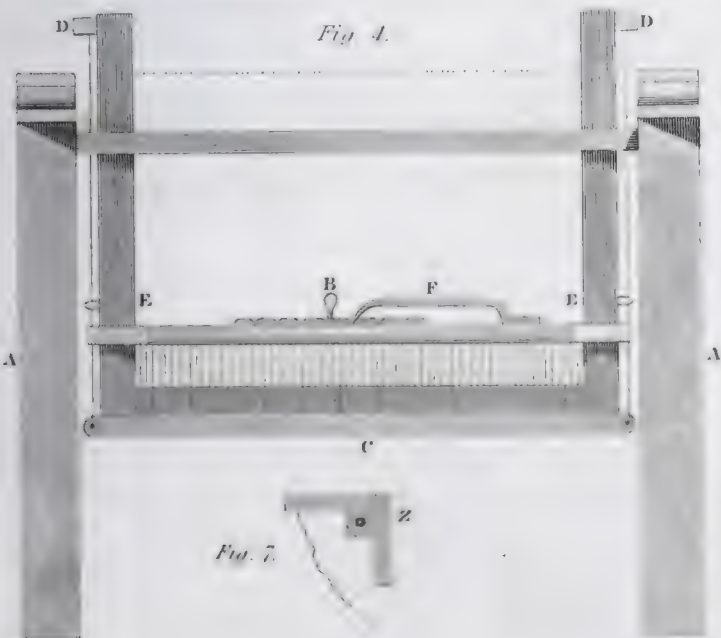






Fig. 4.

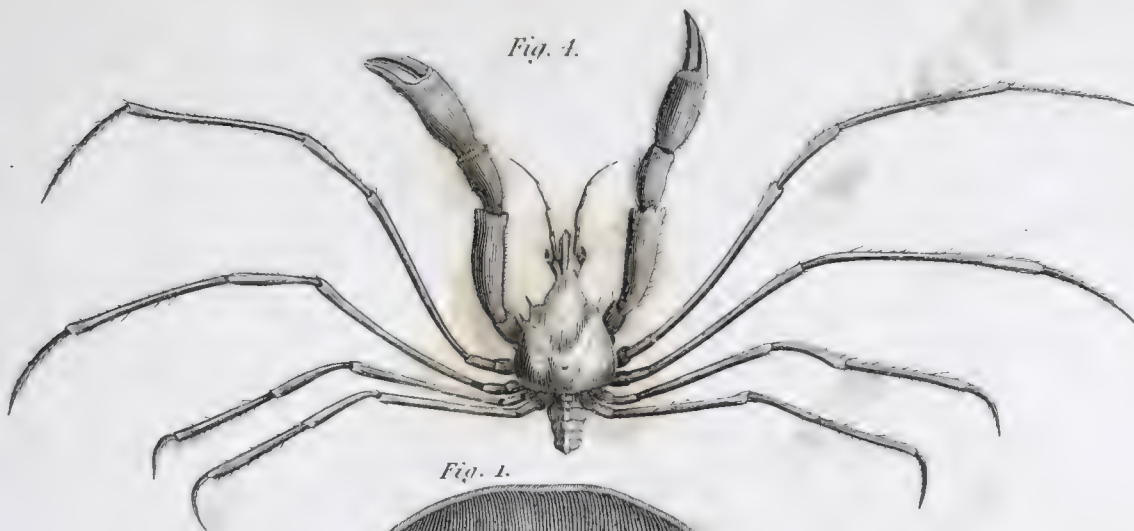


Fig. 1.

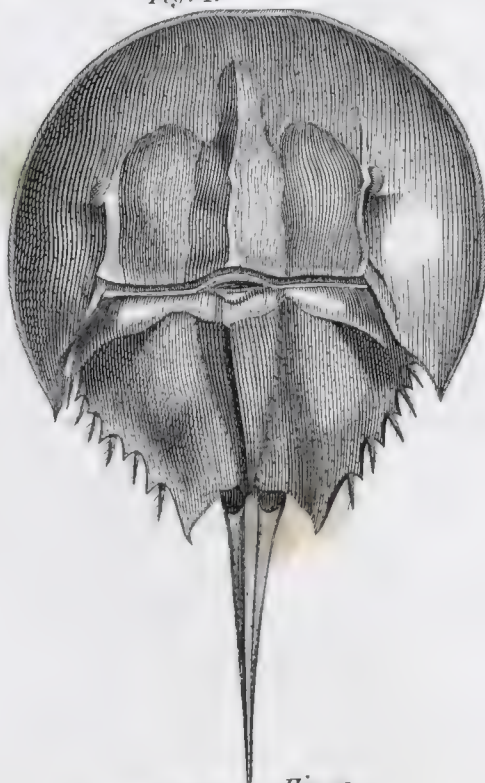


Fig. 9.



Fig. 8.



Fig. 7.



Fig. 6.



Fig. 12.



Fig. 2.



Fig. 11.

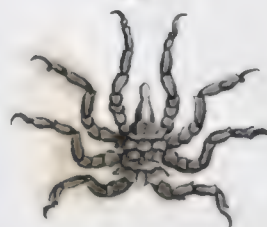
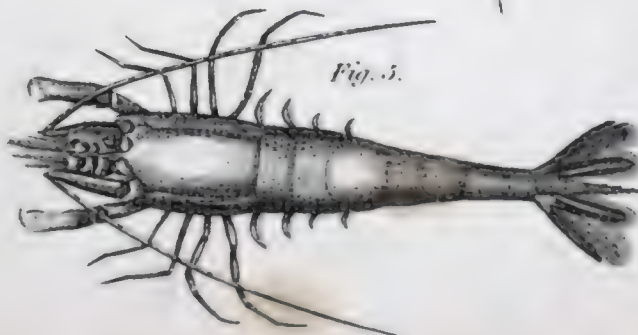


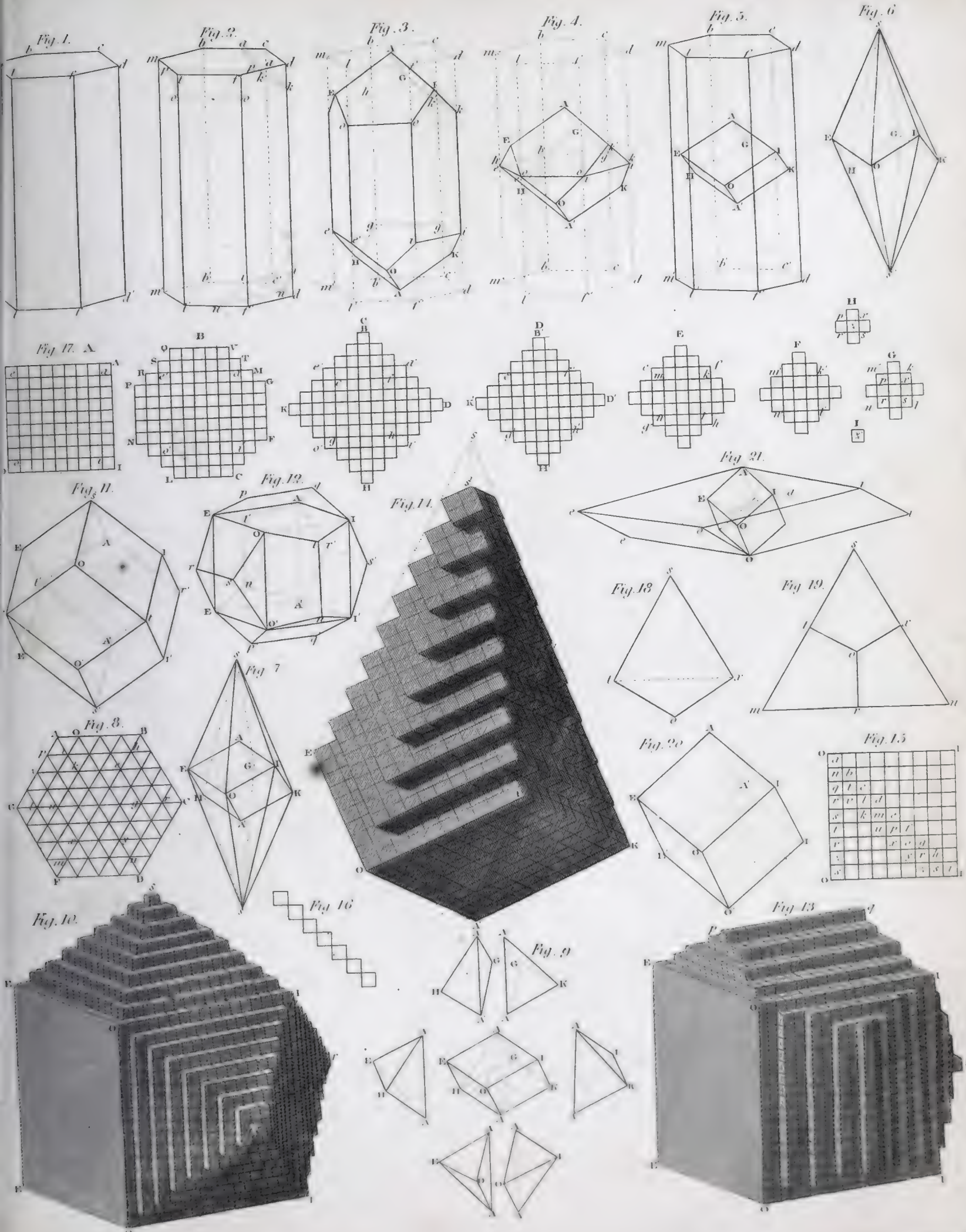
Fig. 3.



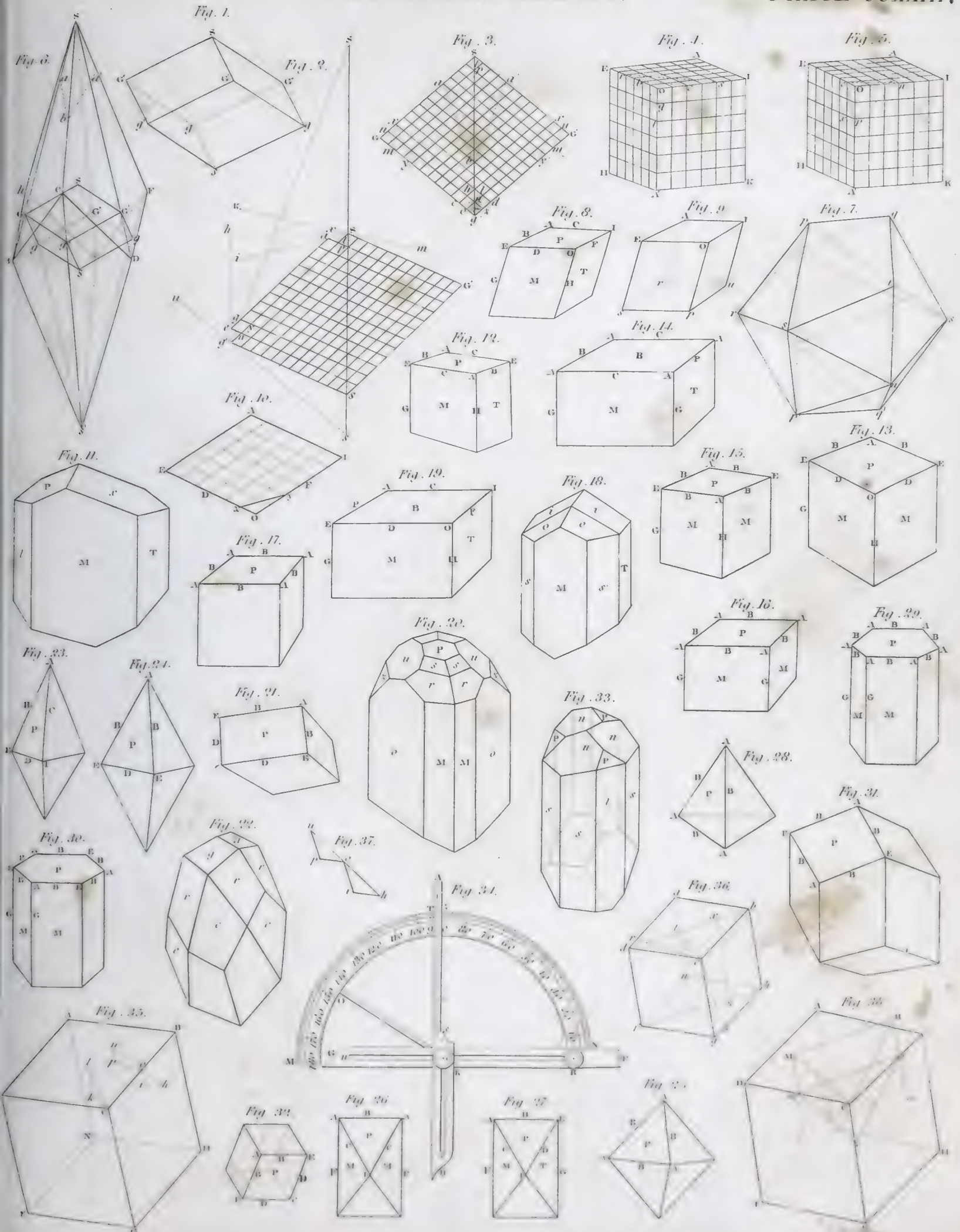
Fig. 5.



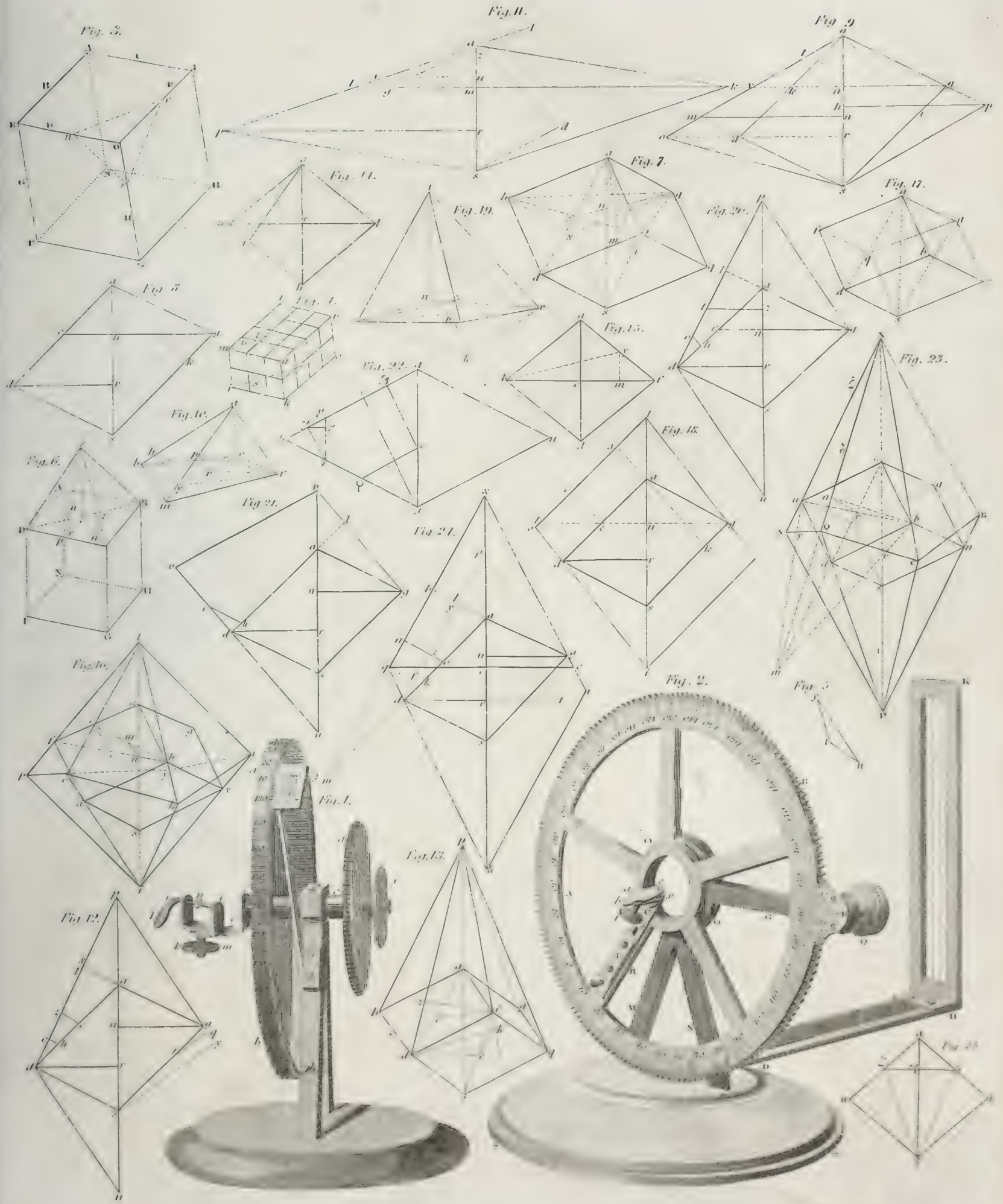
















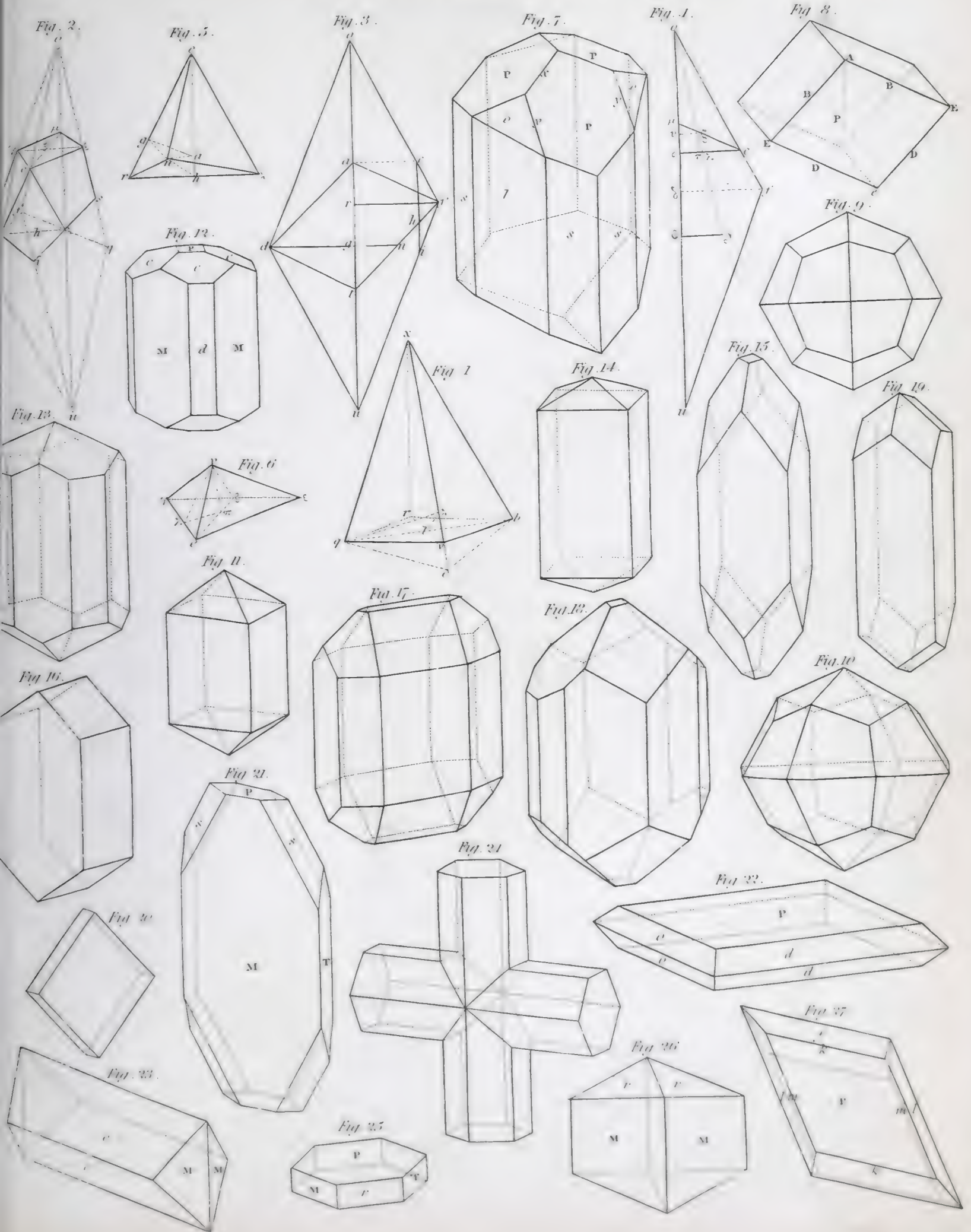




Fig. 1.

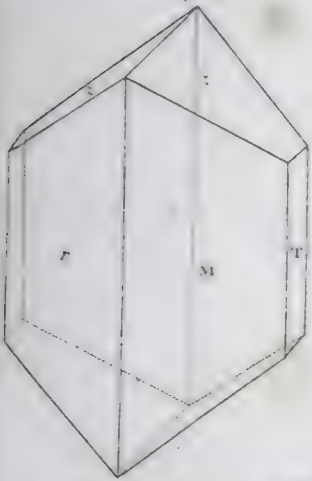


Fig. 2.

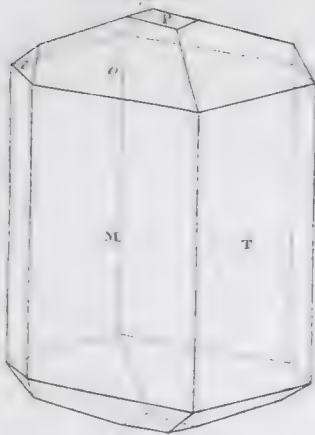


Fig. 3.

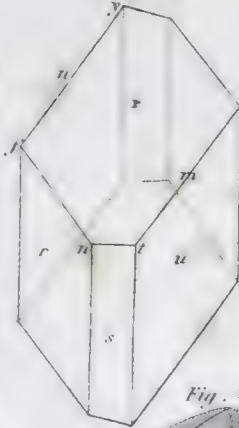


Fig. 4.

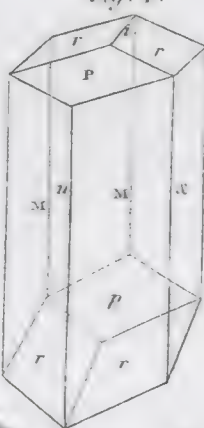


Fig. 5.

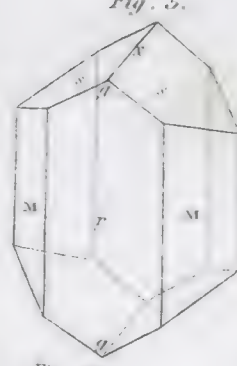


Fig. 6.

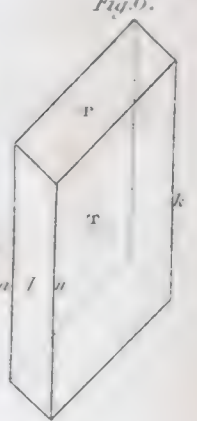


Fig. 2.

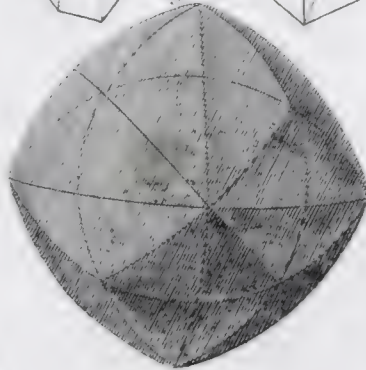


Fig. 22.



Fig. 14.



Fig. 7.

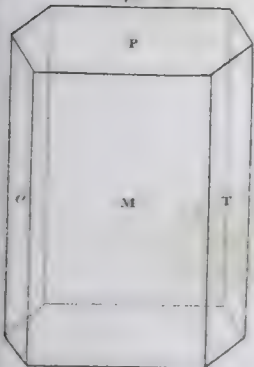


Fig. 6.



Fig. 9.

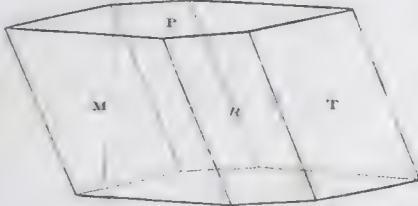


Fig. 10.



Fig. 17.

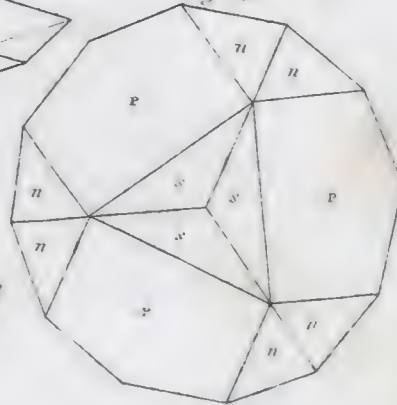


Fig. 16.

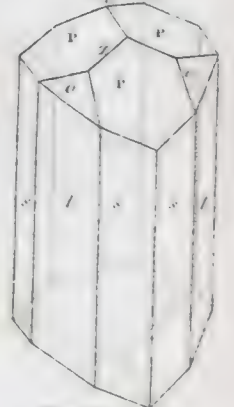


Fig. 15.



Fig. 19.

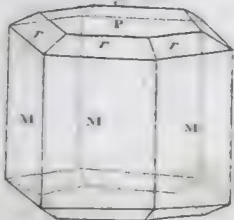


Fig. 12.

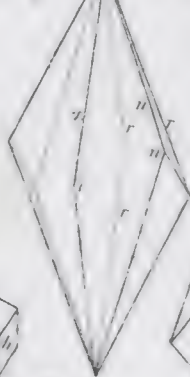


Fig. 11.



Fig. 18.

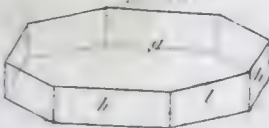


Fig. 13.



Fig. 30.

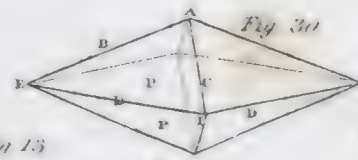


Fig. 14.

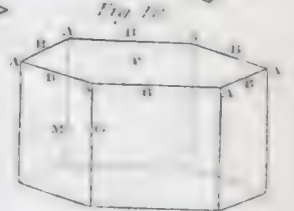


Fig. 27.

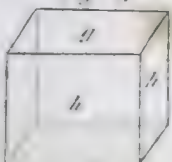


Fig. 20.

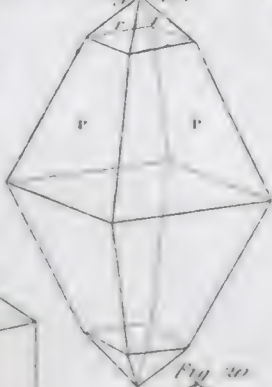


Fig. 30.

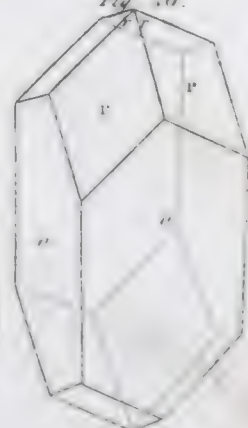


Fig. 21.



Fig. 23.



Fig. 25.



Fig. 30.

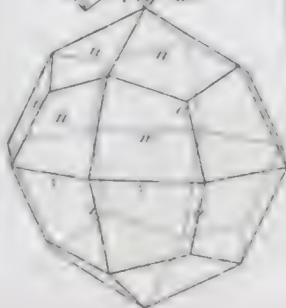
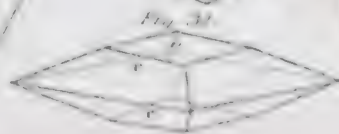


Fig. 31.





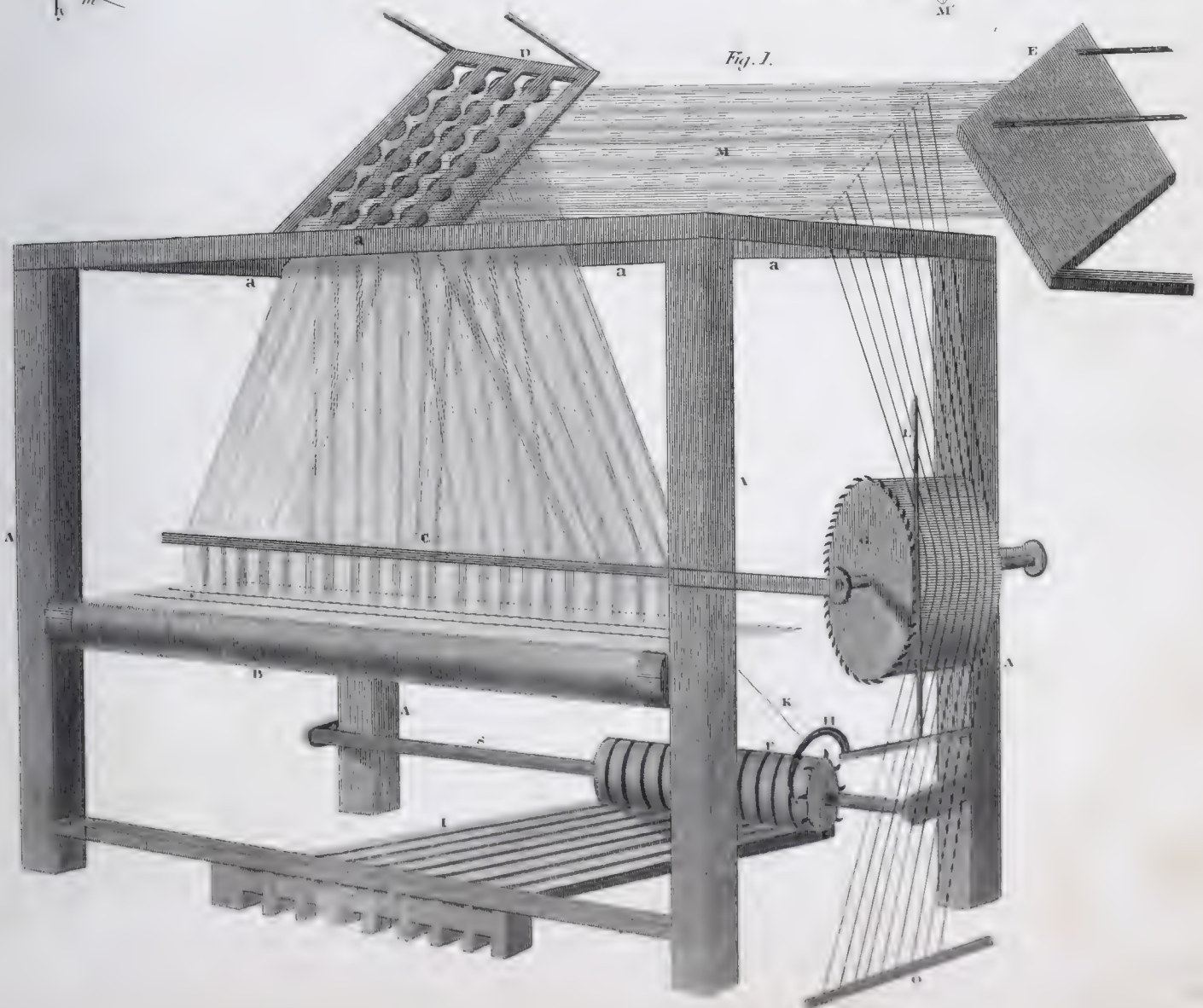
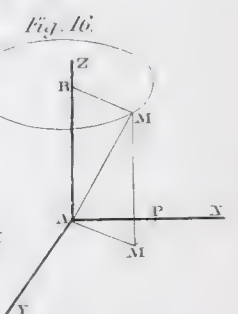
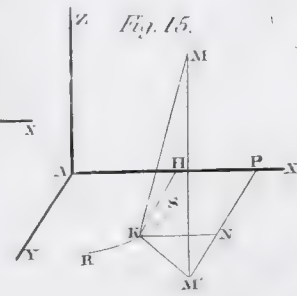
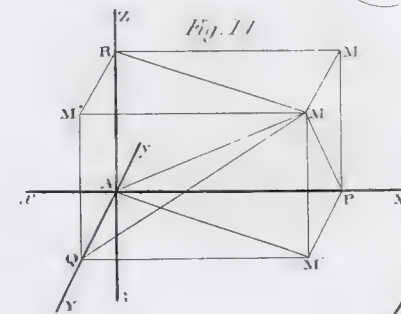
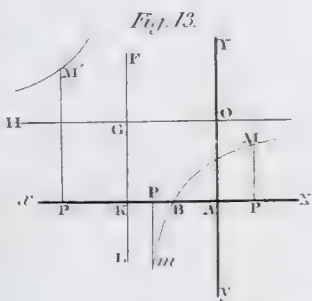
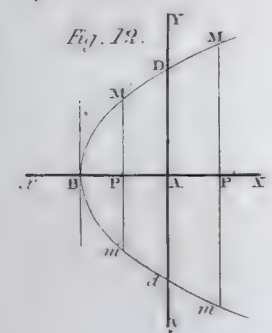
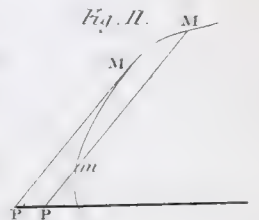
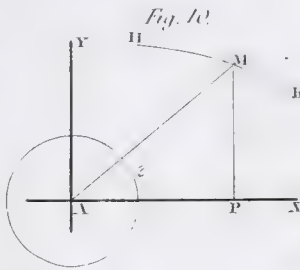
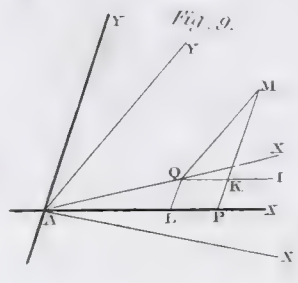
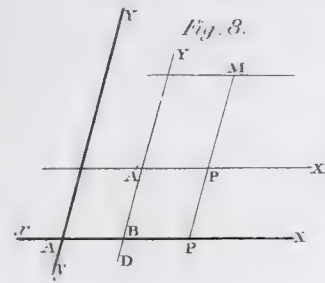
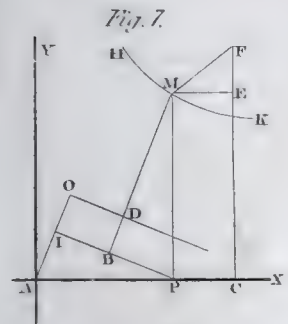
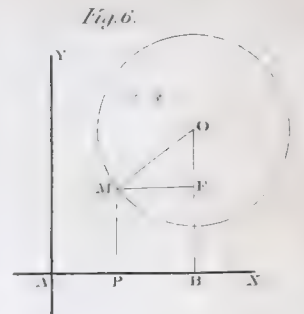
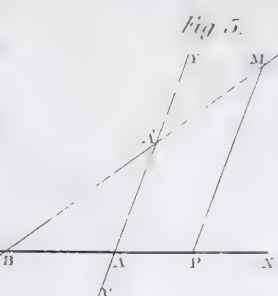
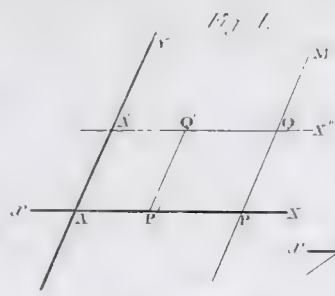
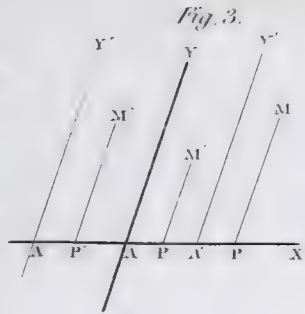
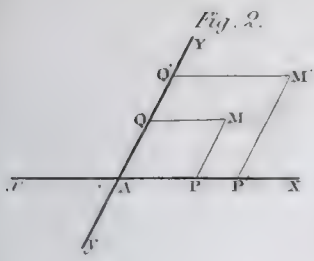




Fig. 4.

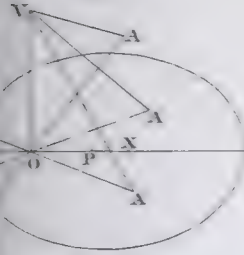


Fig. 1.  
Circus Dial

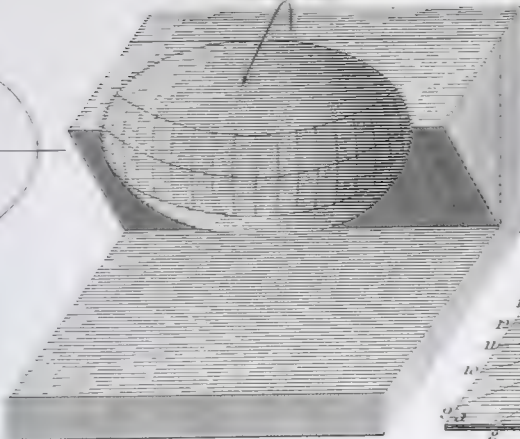


Fig. 3.

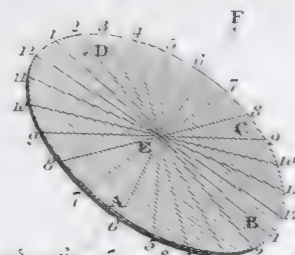


Fig. 8.  
Horizontal Dial

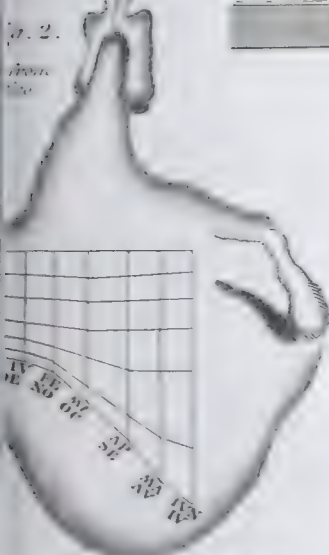
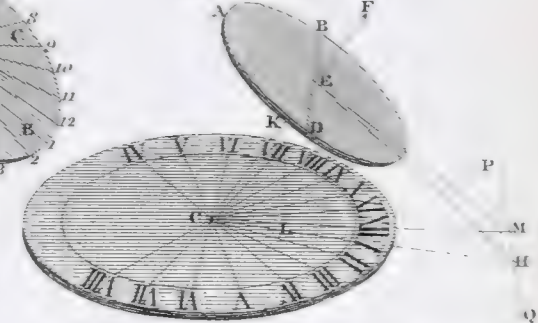


Fig. 7.

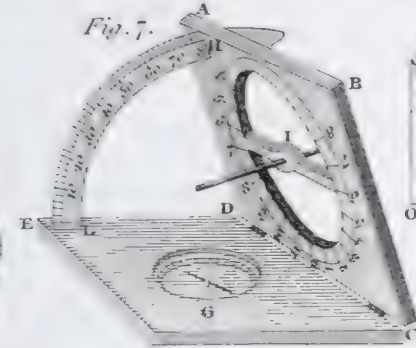


Fig. 5.

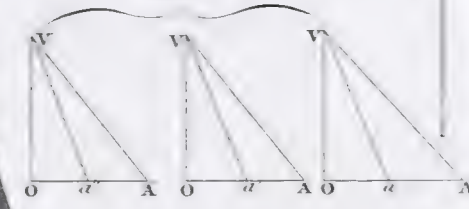


Fig. 6.

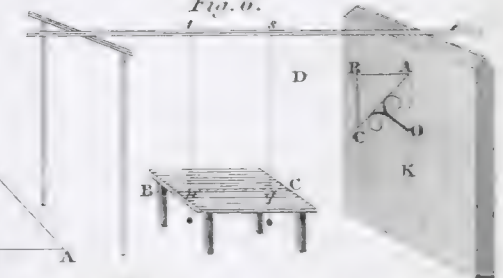


Fig. 10.

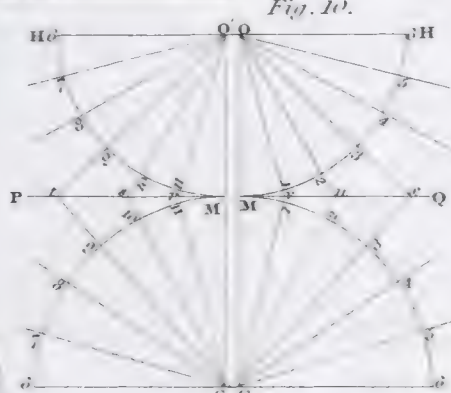


Fig. 9.

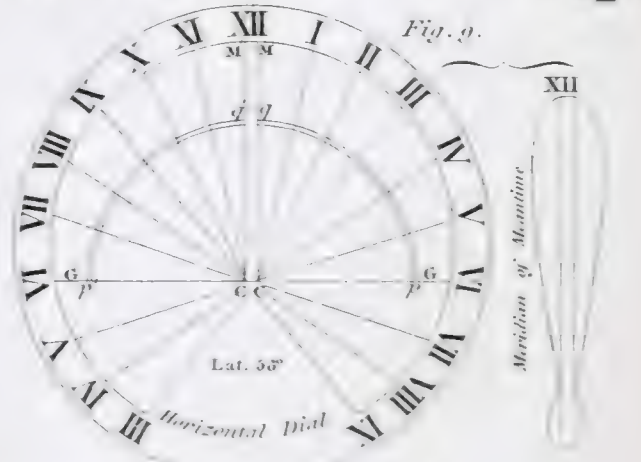


Fig. 12.



Fig. 11.



Fig. 13.



Fig. 11.



Fig. 15.



Fig. 16.  
South Dial

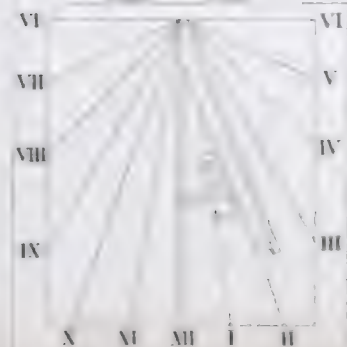


Fig. 17.  
North Dial

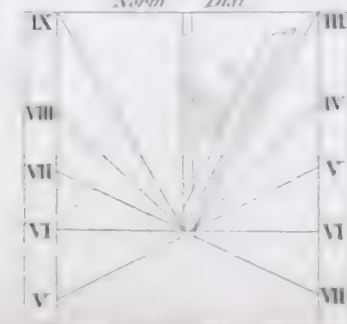
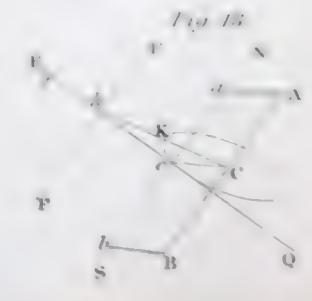


Fig. 15.



AB Fig. 9. the morning hours from III to VI are found by excluding the afternoon hours from III to VI and the





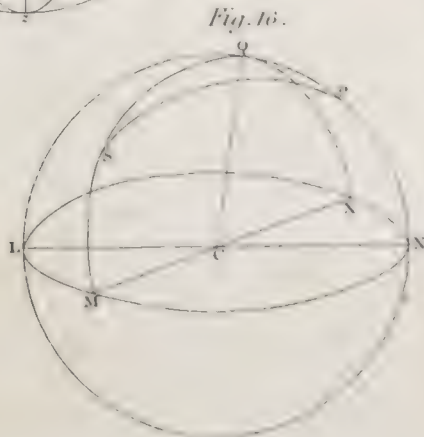
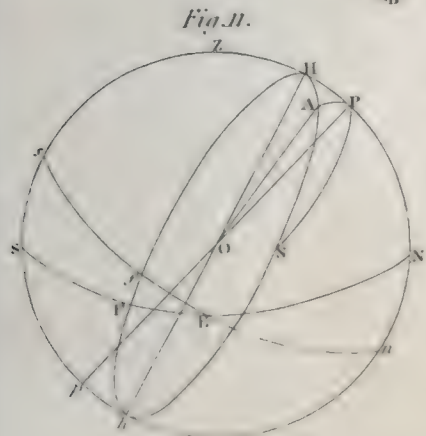
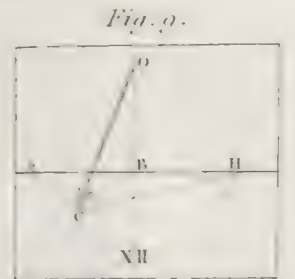
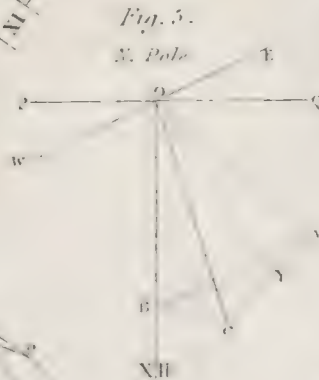
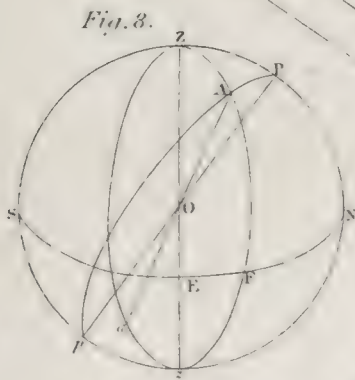
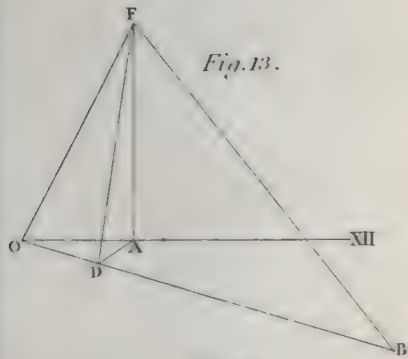
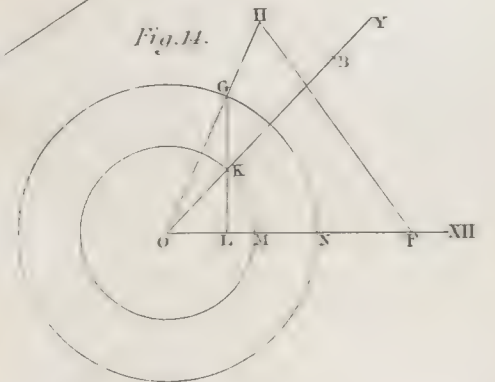
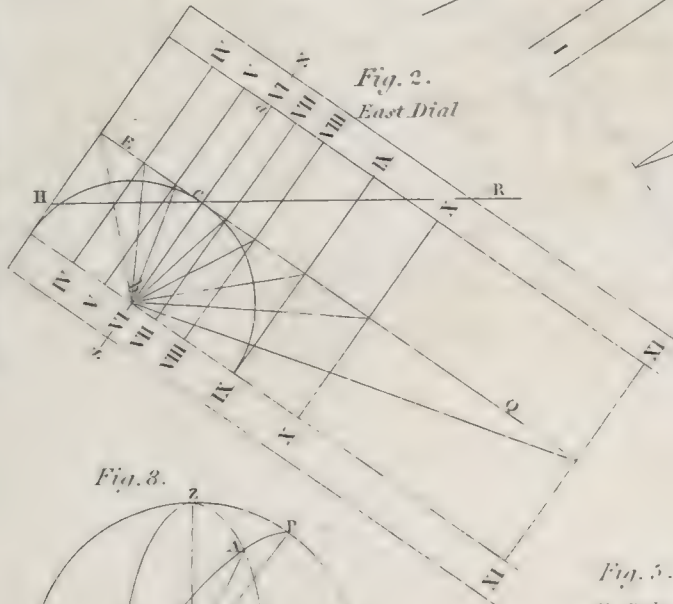
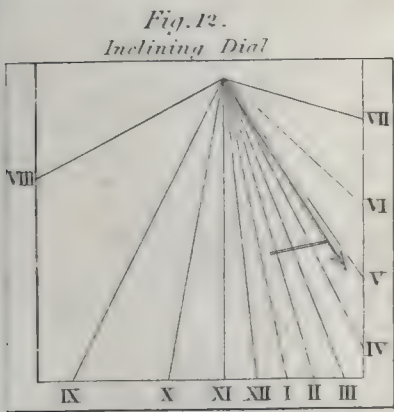
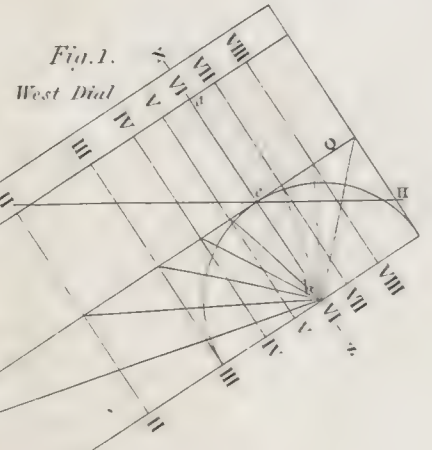
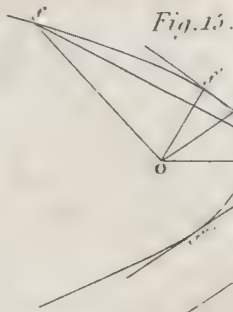
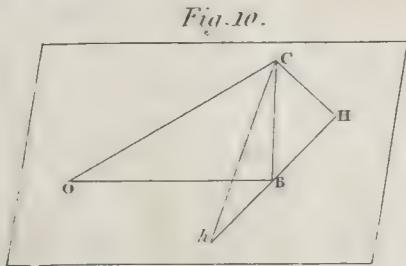
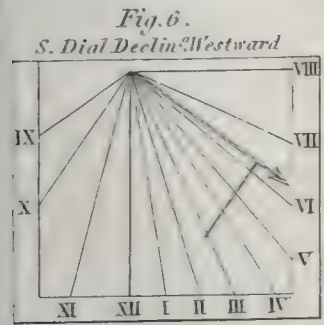
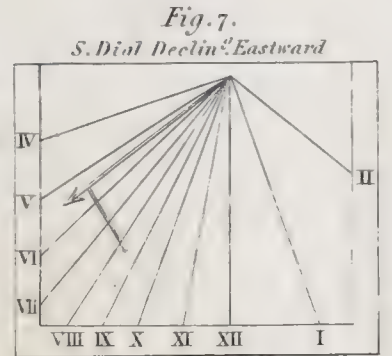
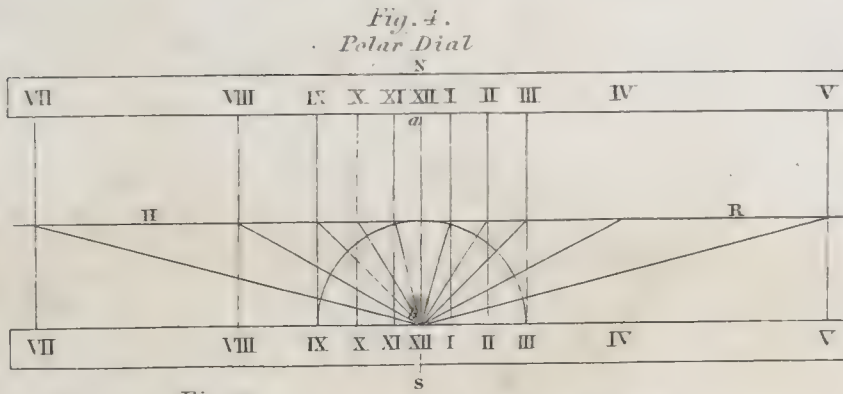
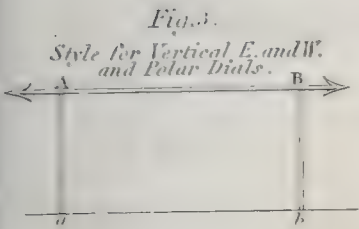
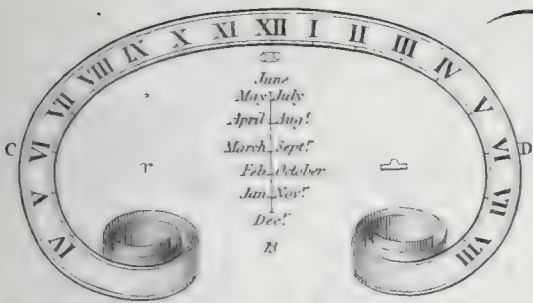




Fig. 2.



Analemmatic Dial

Fig. 1.

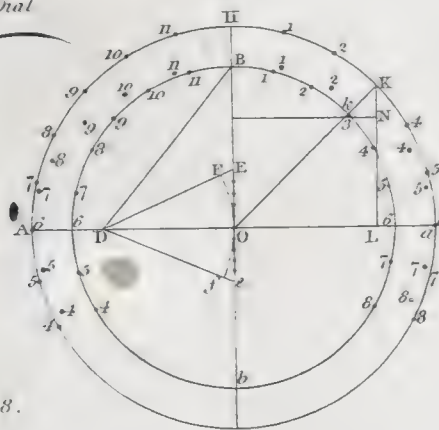


Fig. 3.  
Lambert's Dial

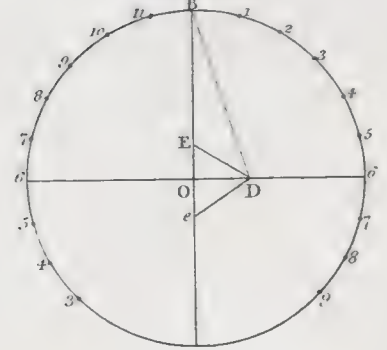


Fig. 5.  
Card Dial

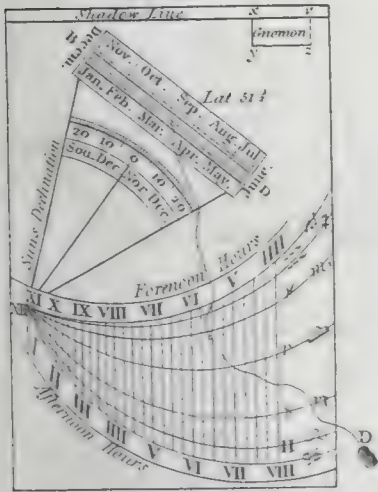


Fig. 8.

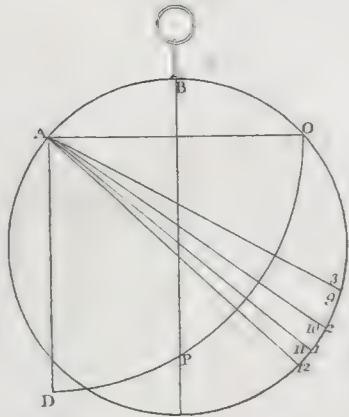


Fig. 4.

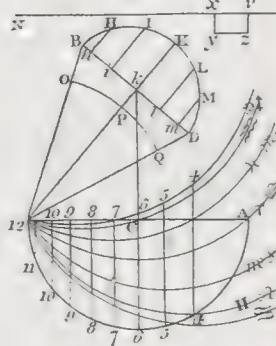


Fig. 9.

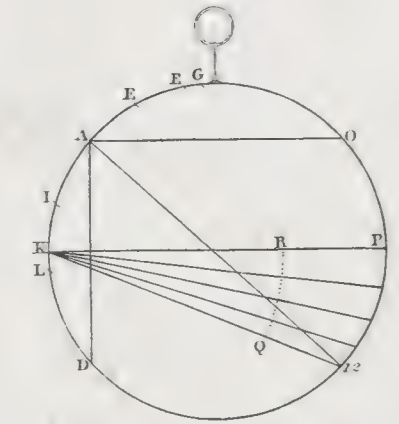


Fig. 15.

Babylonian Dial

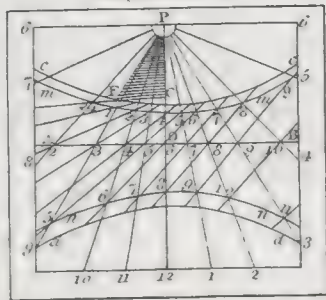


Fig. 7.

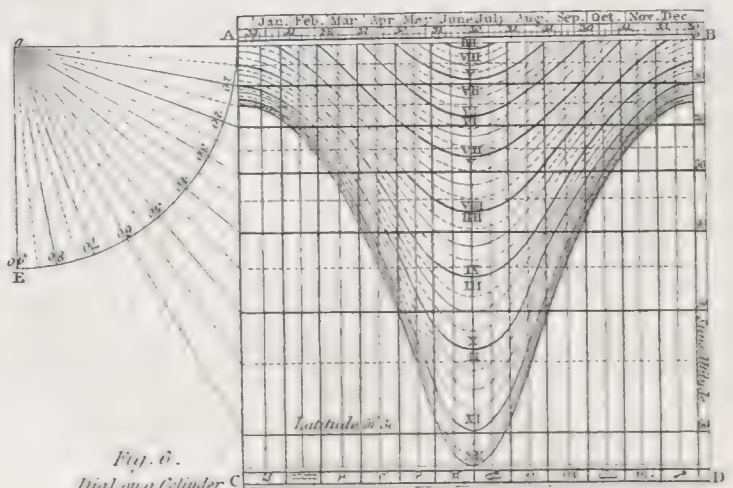


Fig. 12.

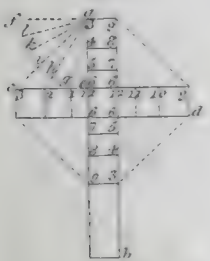


Fig. 11.  
Dial on a Cross

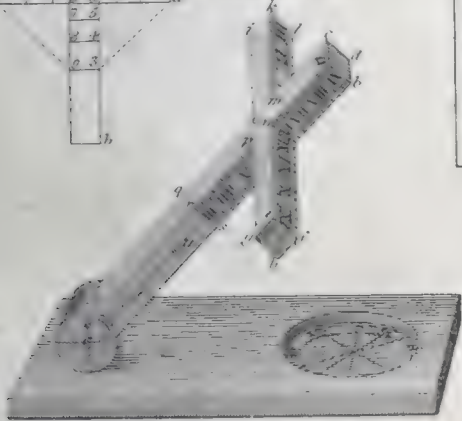


Fig. 13.  
Universal Dial



Fig. 6.  
Dial on a Cylinder



Fig. 10.  
Ring Dial

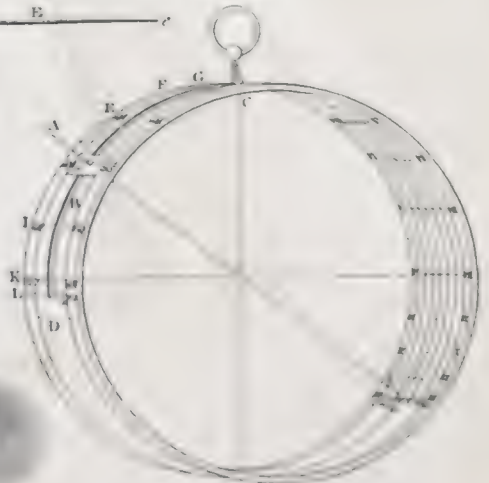


Fig. 14.

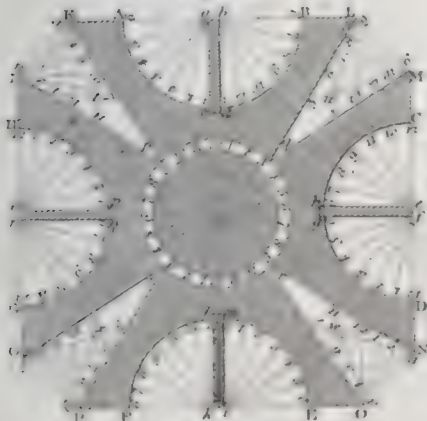




Fig. 5.



Fig. 6.

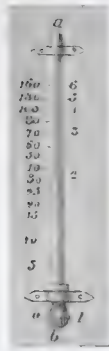
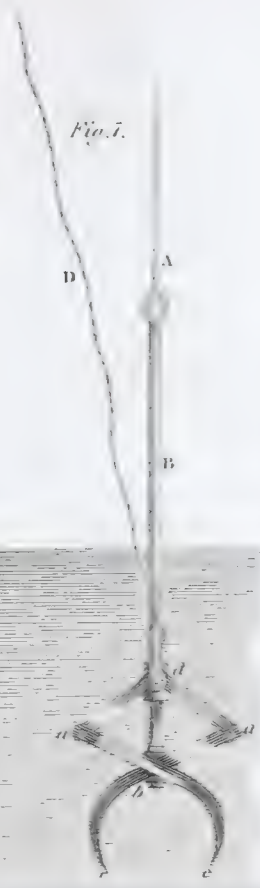
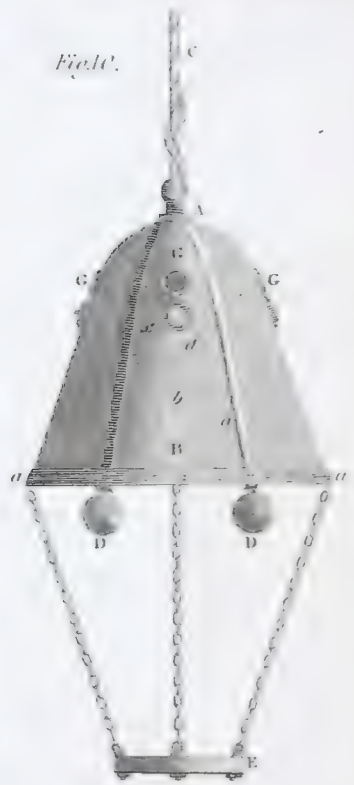


Fig. 7.



TRIEWALDS DIVING BELL

Fig. 8.



Row's DIVING CHEST

Fig. 4.

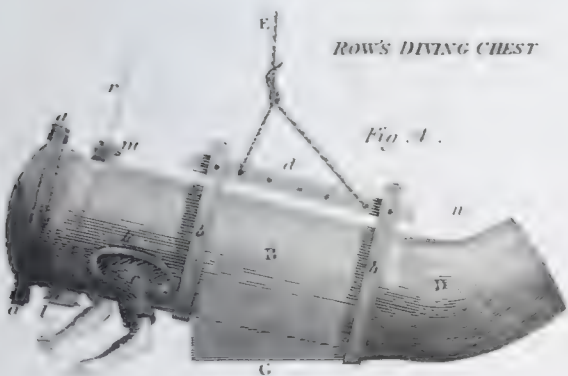


Fig. 3.

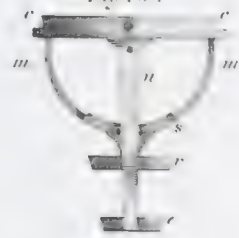


Fig. 2.

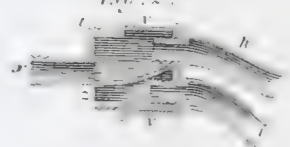


Fig. 1.



BUSHNELL'S SUBMERSIVE VESSEL

Fig. 9.

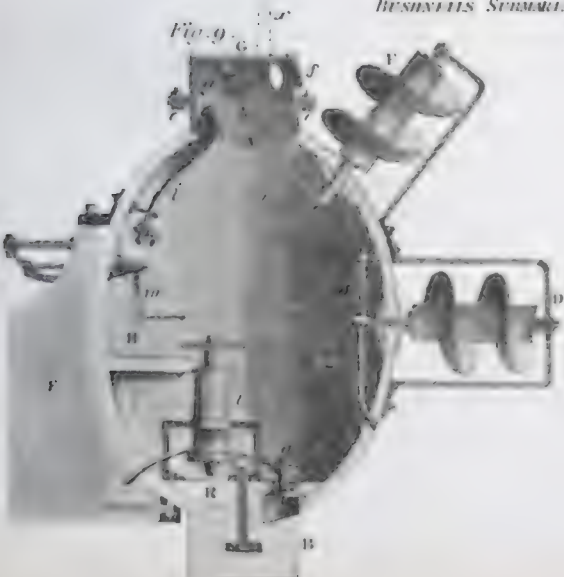
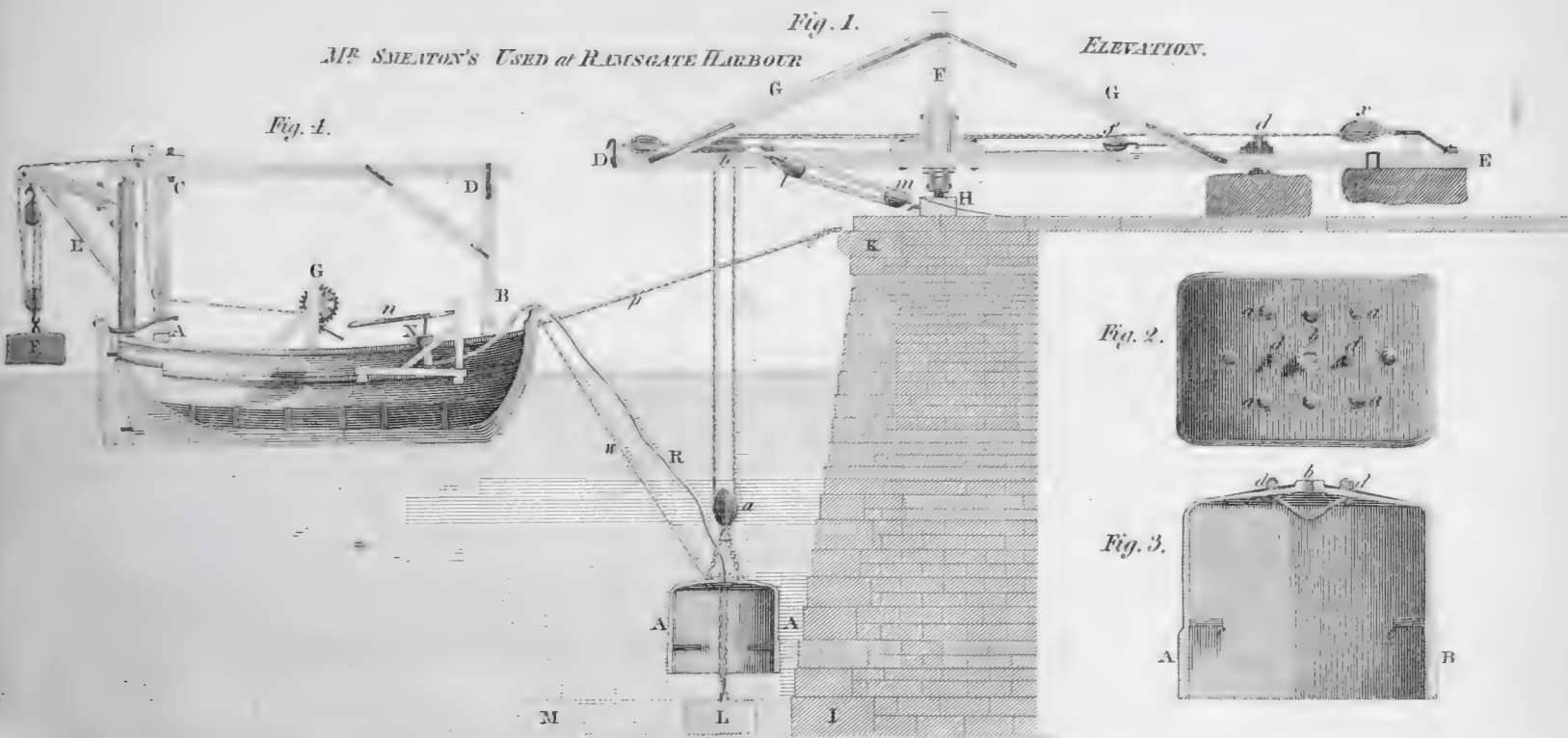


Fig. 3.

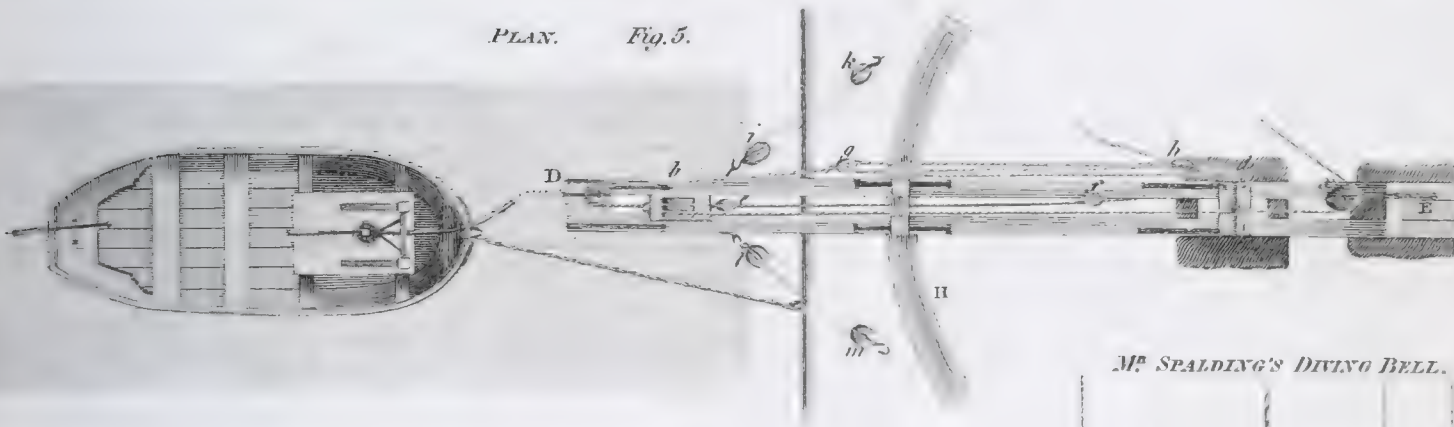




Fig. 1. *MR. SMEATON'S Used at RINGSGATE HARBOUR* ELEVATION.



PLAN. Fig. 5.



TACKLE for WORKING a DIVING BELL.

Fig. 8.

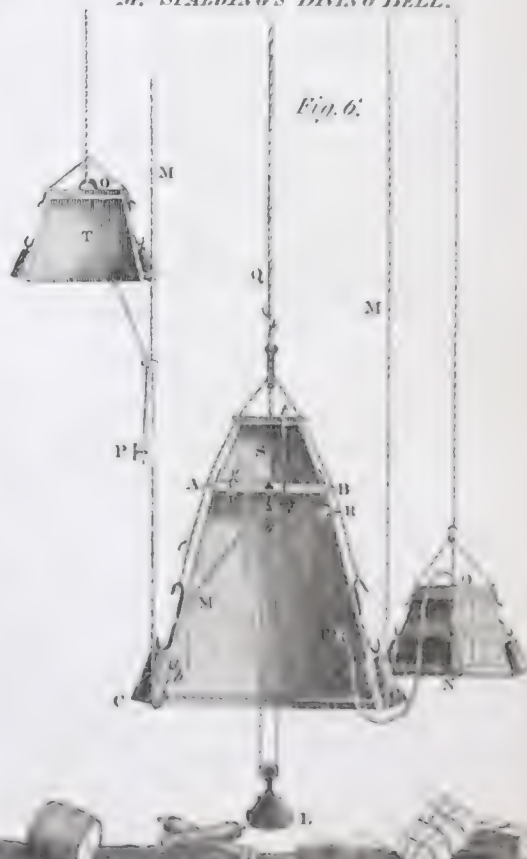


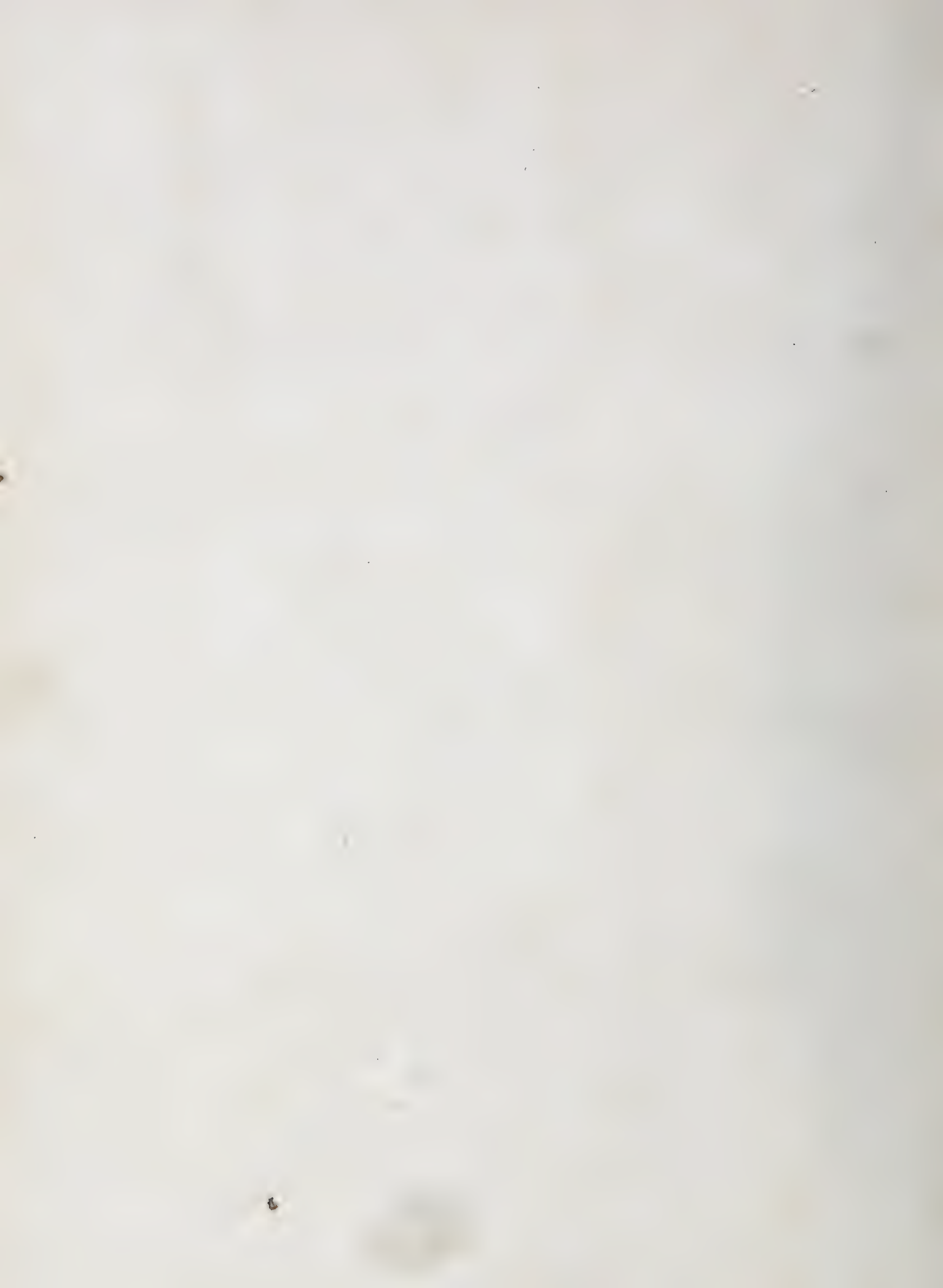
Fig. 7.



MR. SPALDING'S DIVING BELL.

Fig. 6.







TONSO  
Fig. 3.

LACONON  
Fig. 1.

HERCULES  
Fig. 2.





DRAWING.

PLATE CCXXXI.

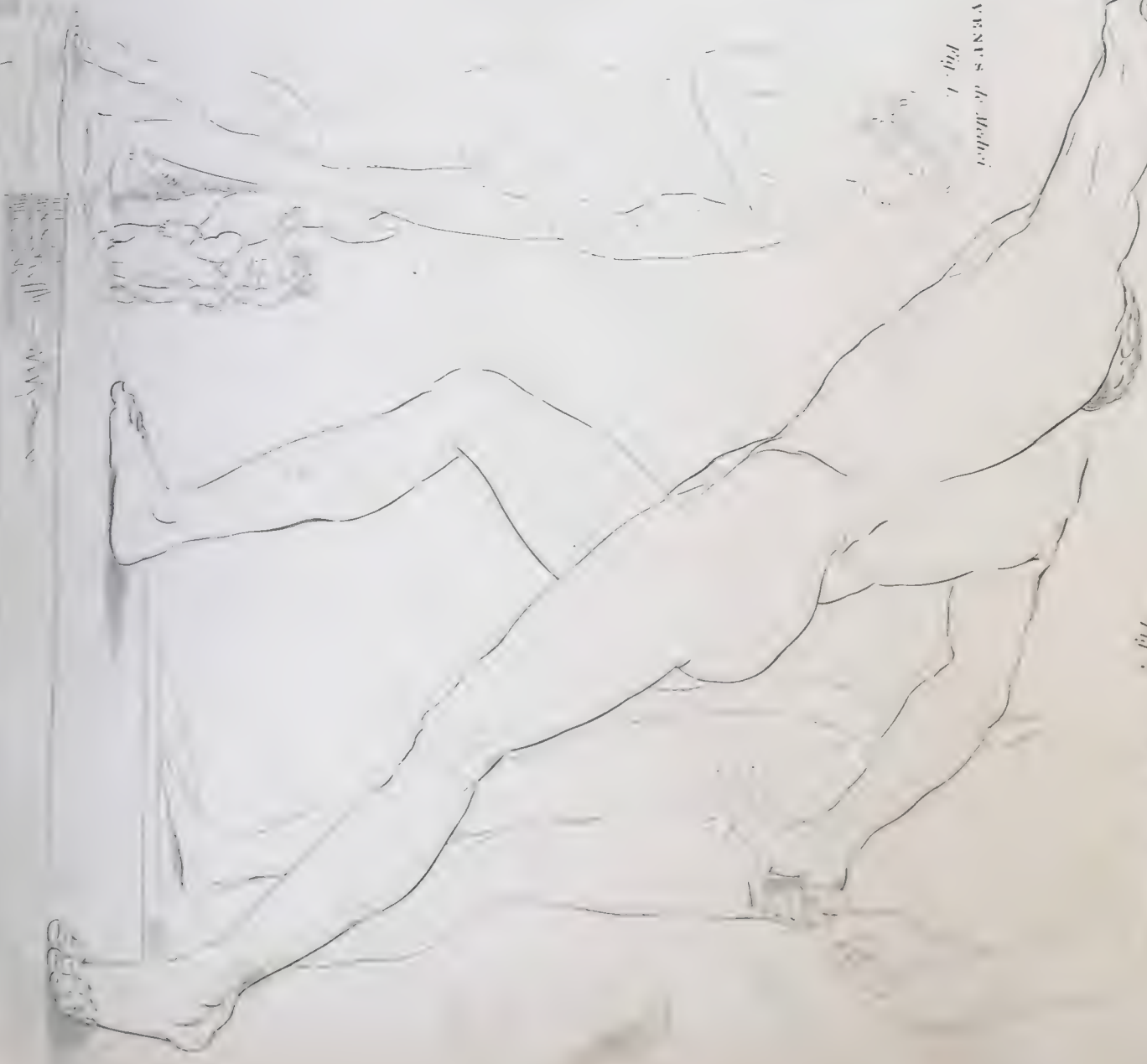
APOLLON BELVA DEBEE  
Fig. 1.



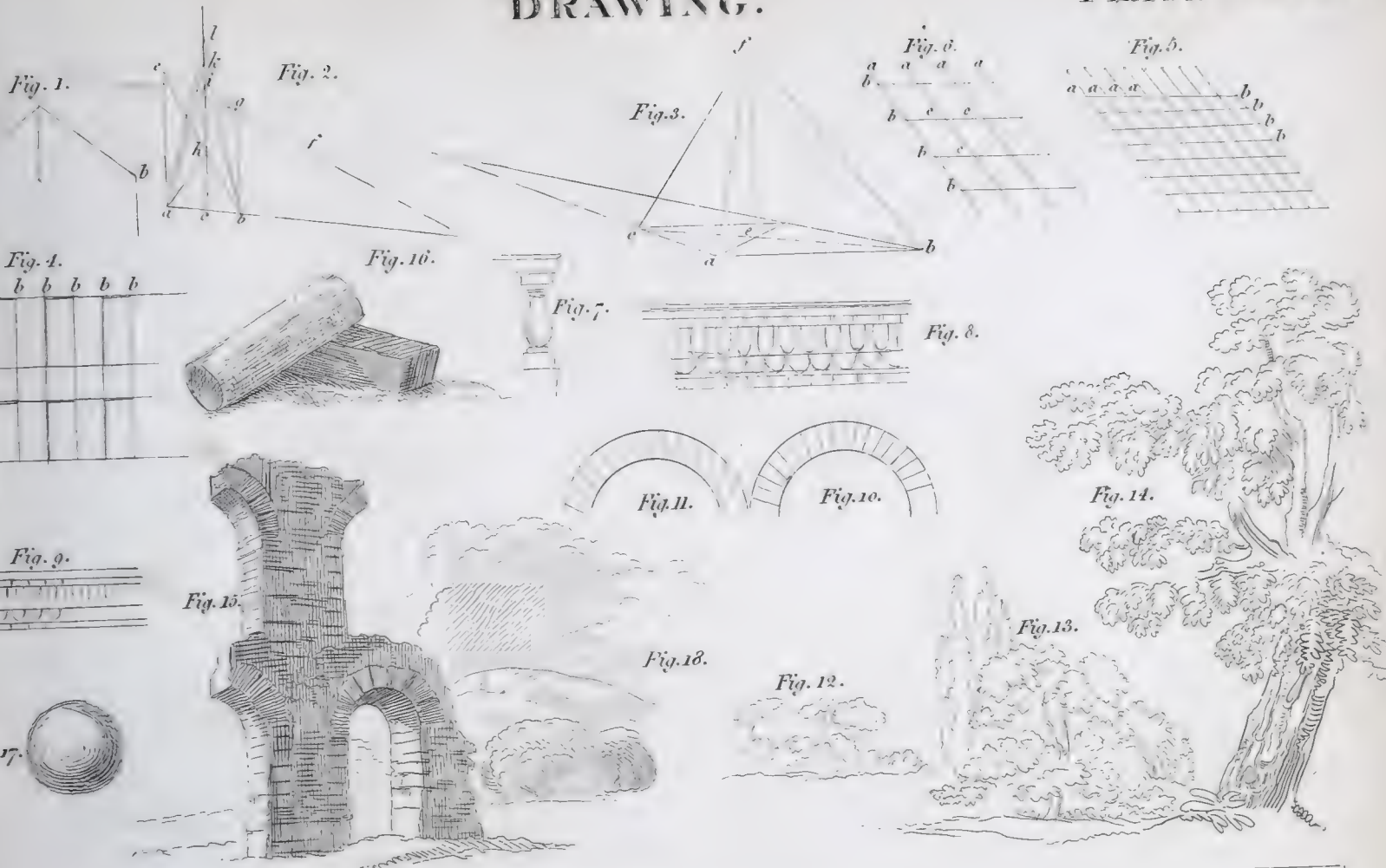
VENUS de Medici  
Fig. 1.

GLADIATOR  
Fig. 2.

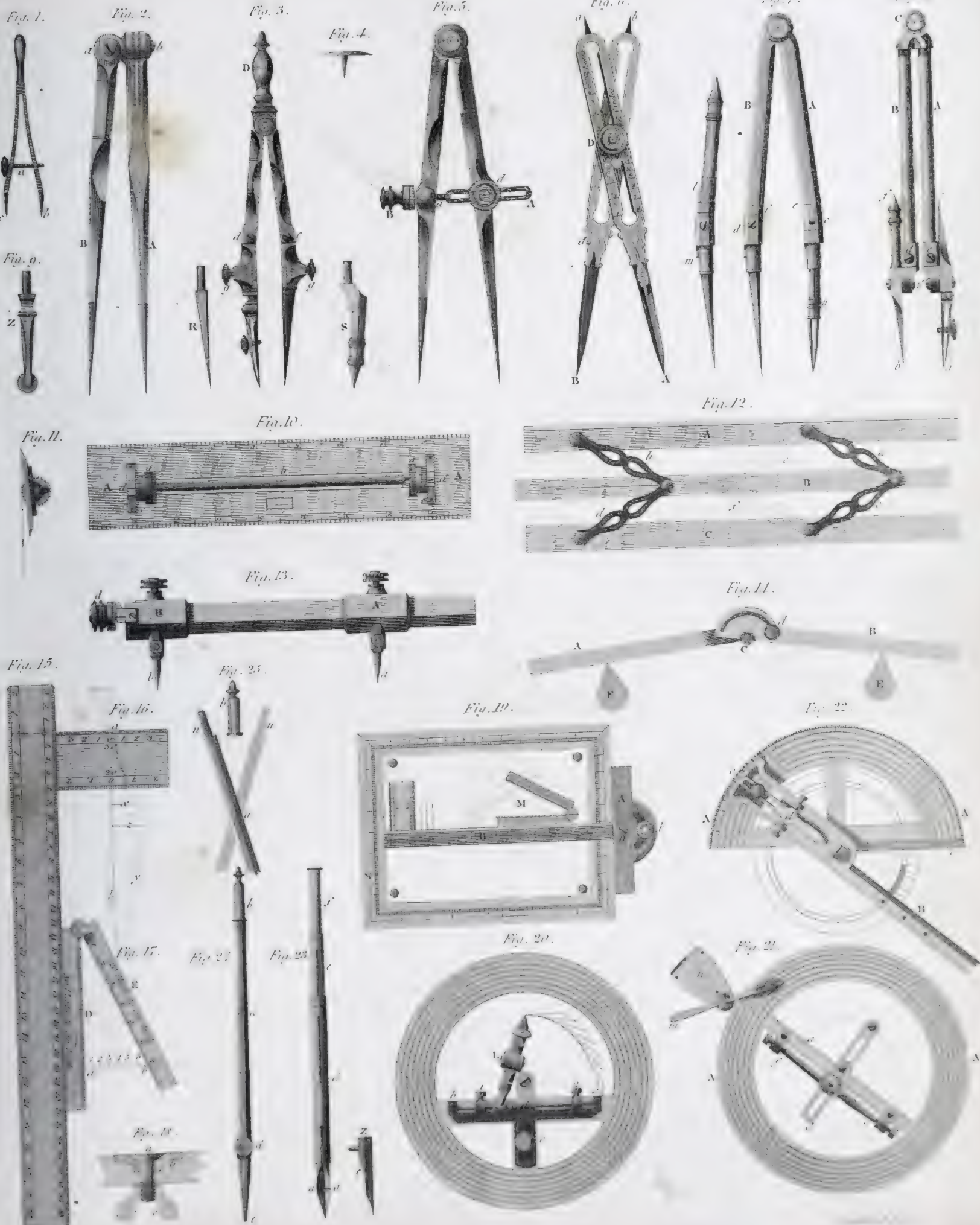
ANTINOUS  
Fig. 2.















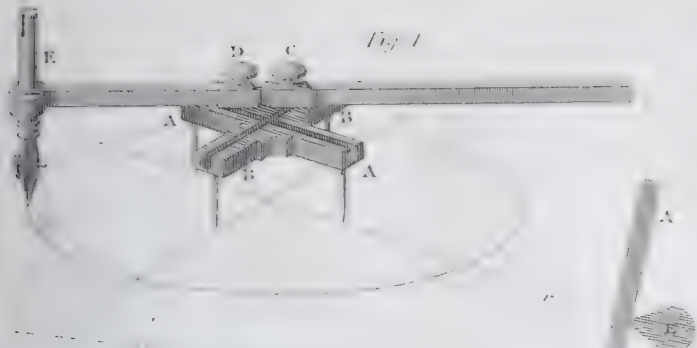


Fig. 1



Fig. 6.

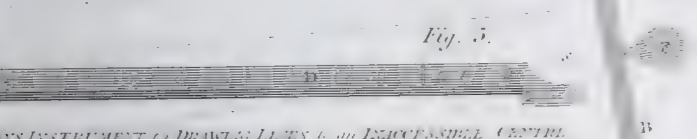


Fig. 5.

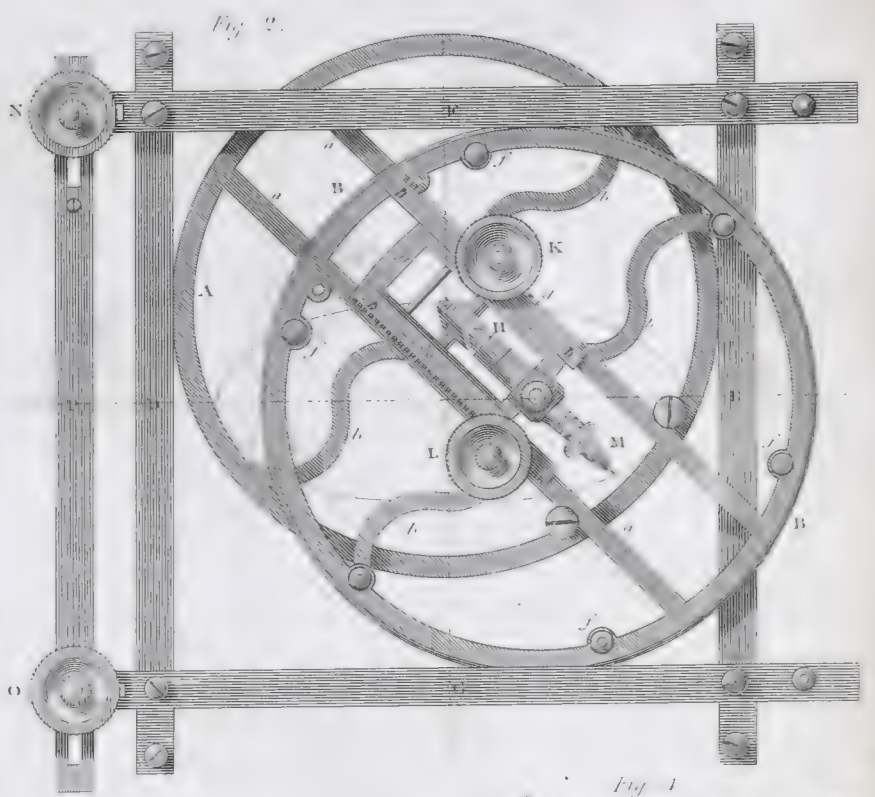


Fig. 2.

FAREY'S INSTRUMENT for DRAWING LINES & an INFINITE SPHERICAL CENTRE

FAREY'S INSTRUMENT for DRAWING ELLIPSES



Fig. 11

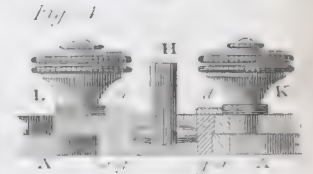


Fig. 4

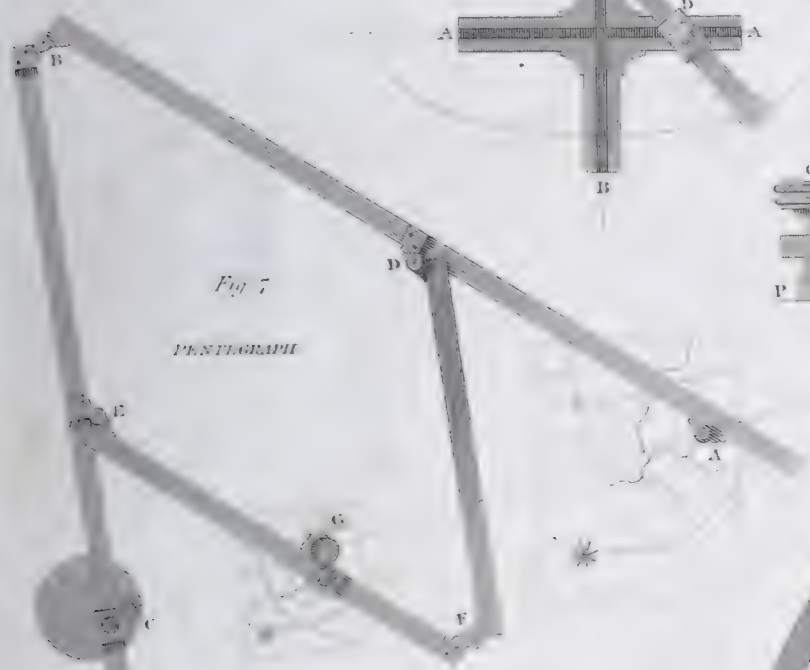


Fig. 7

PANTOGRAPH

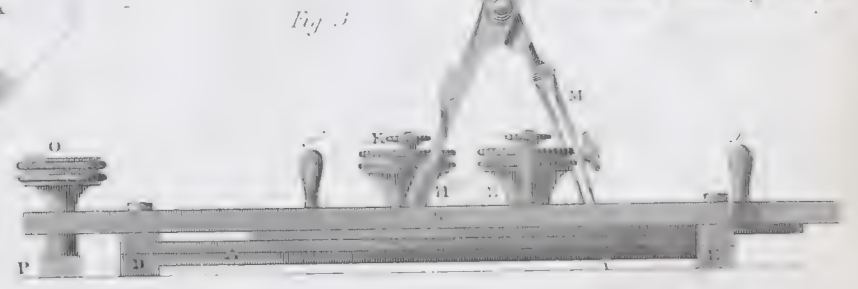


Fig. 3

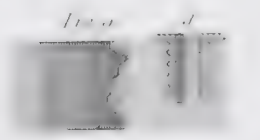


Fig. 8

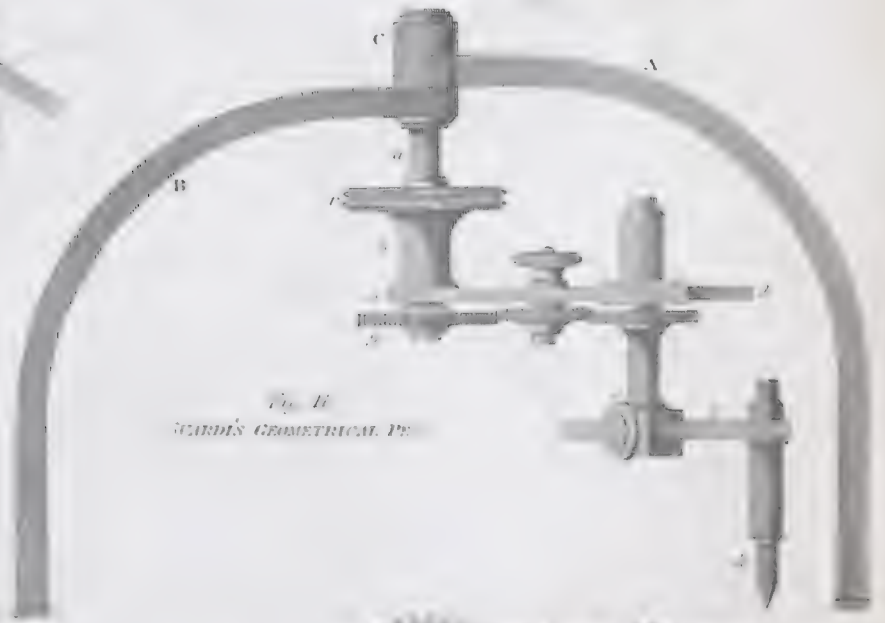


Fig. 10  
SCARD'S GEOMETRICAL PR.



Fig. 9



Fig. 12



Fig. 11



PLAN of the VESSEL  
with one of the  
BUCKET FRAMES REMOVED

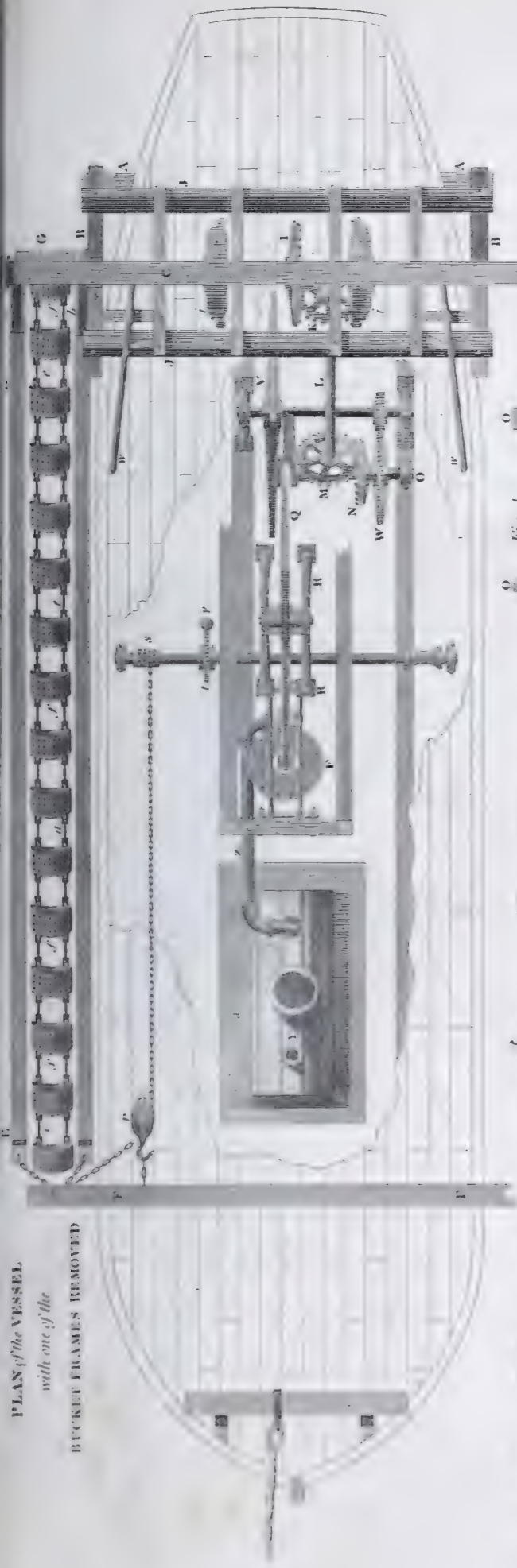


Fig. 3



Fig. 5.

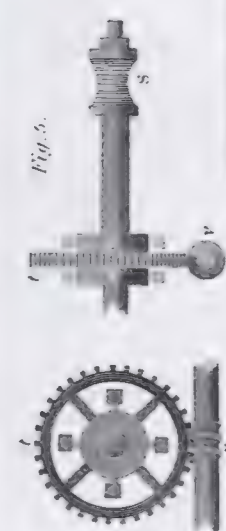
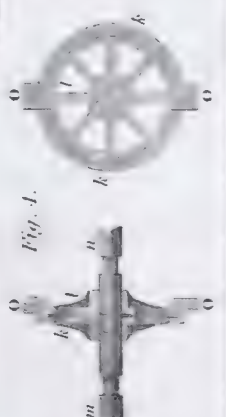


Fig. 4.



ELEVATION  
of a  
DREDGING MACHINE

Fig. 1.





Fig. 1.

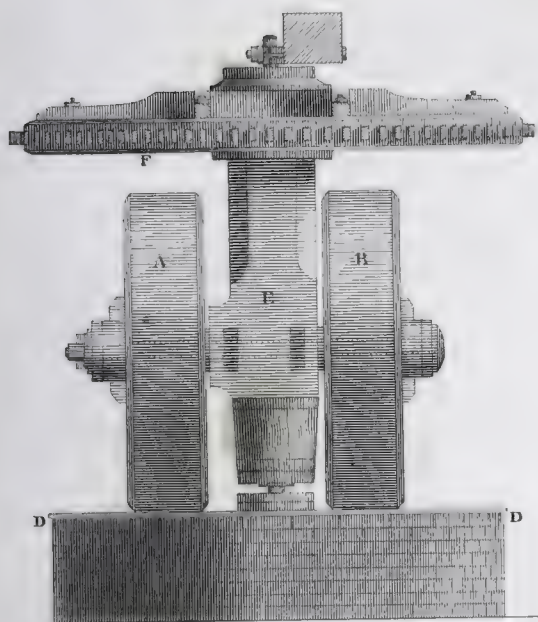


Fig. 2.

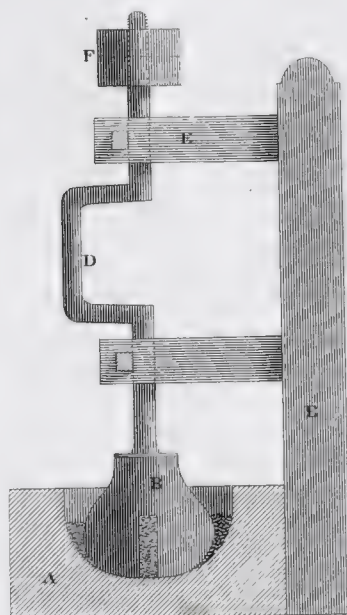


Fig. 3.

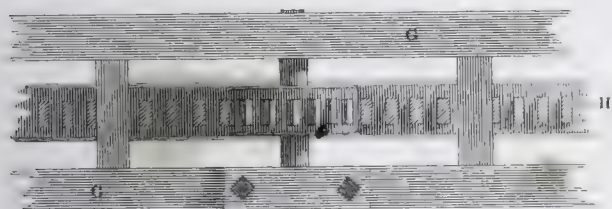
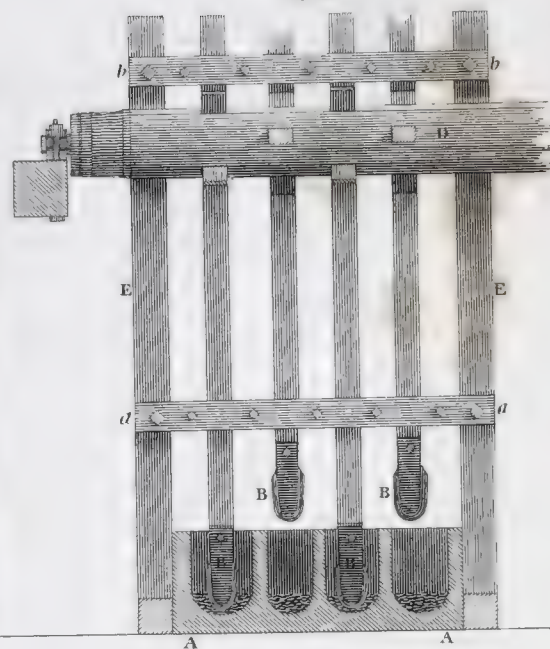


Fig. 6.

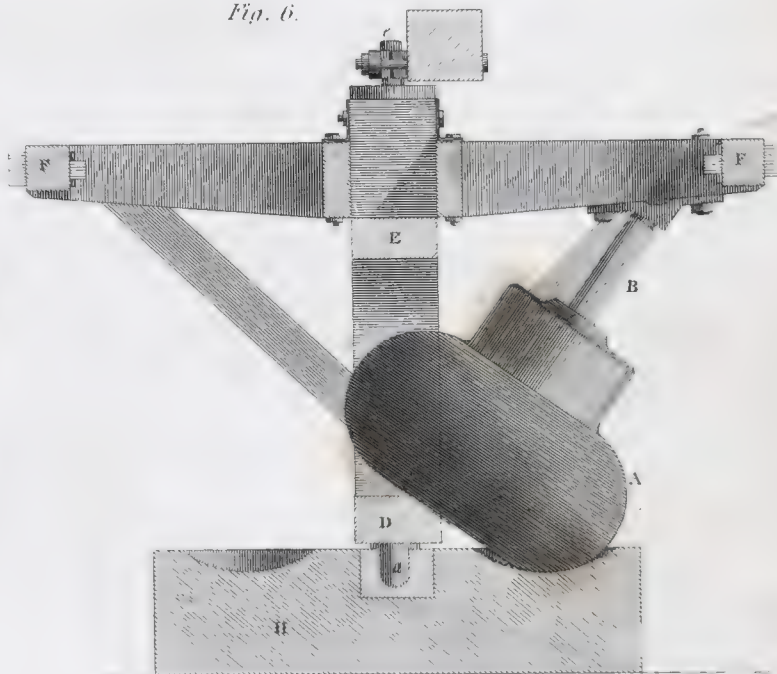


Fig. 1.

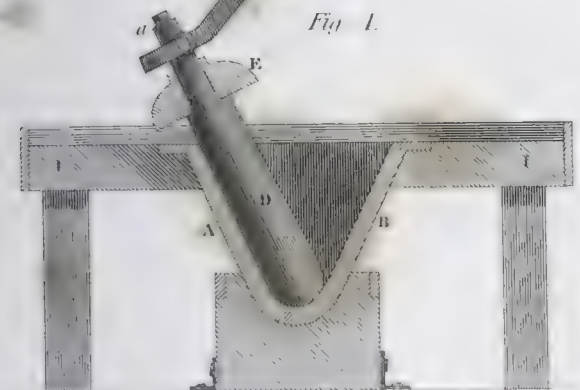


Fig. 5.

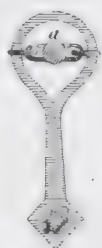


Fig. 7.

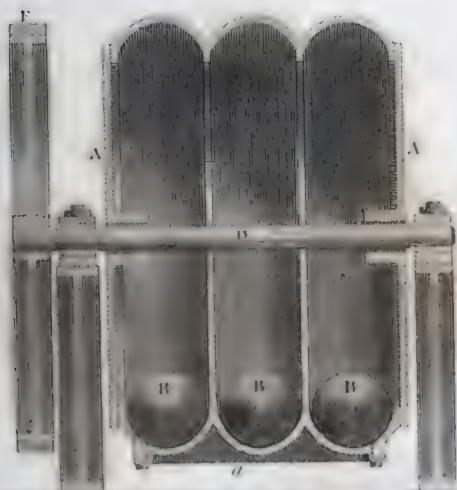


Fig. 8.

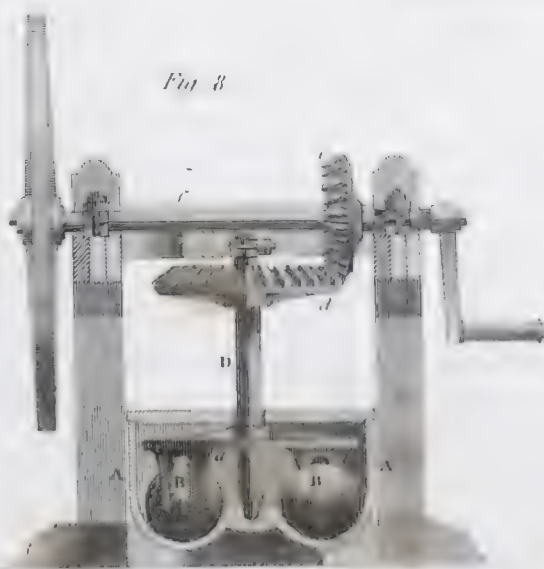
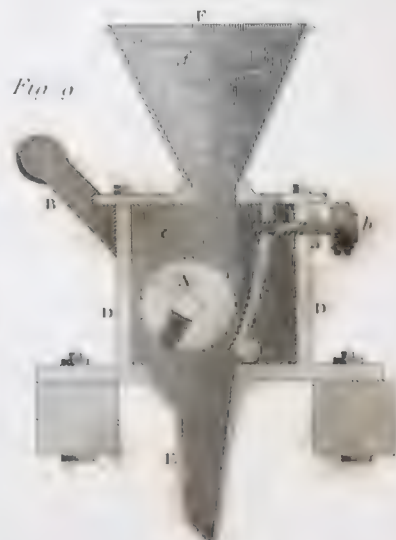
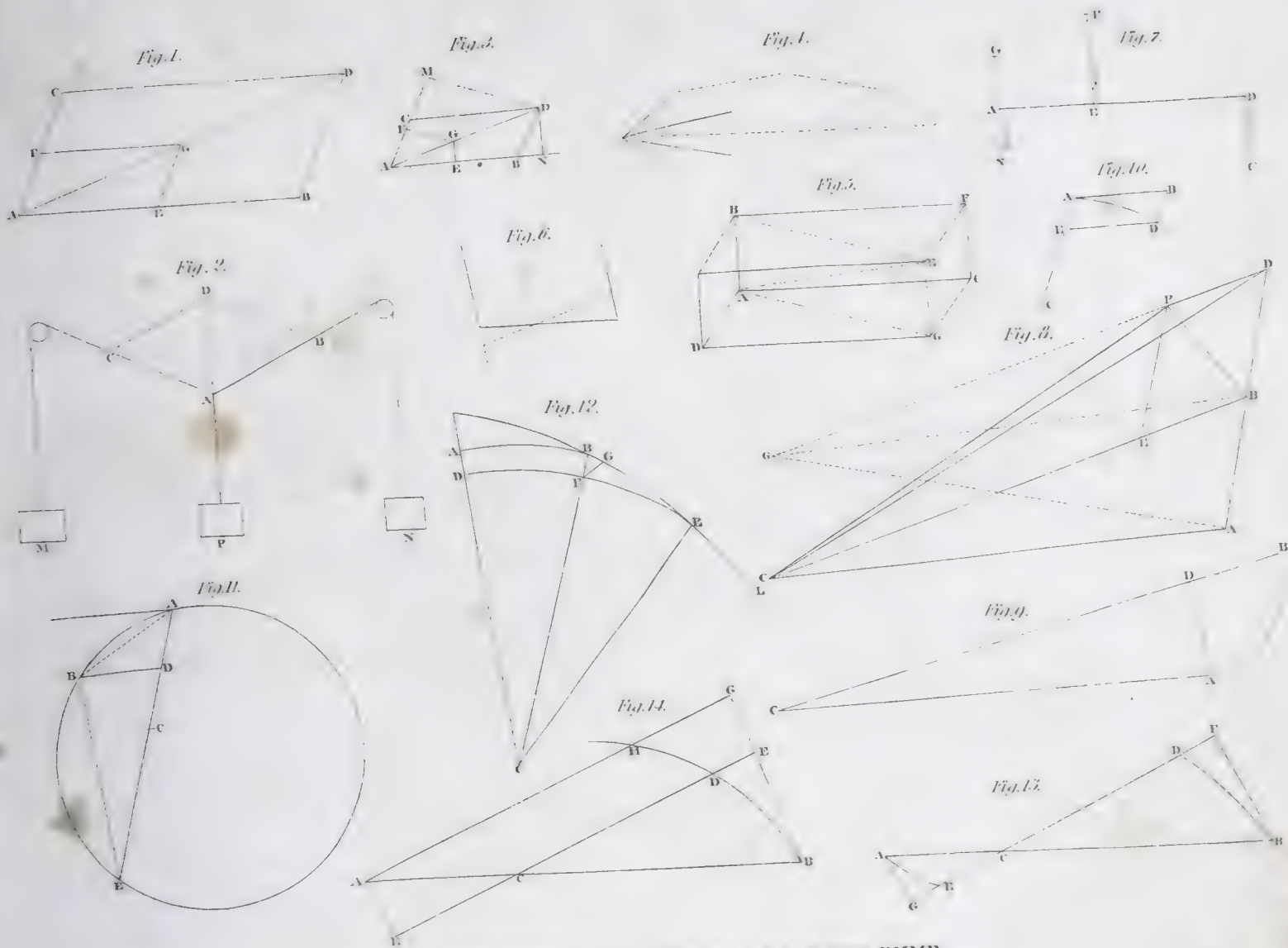


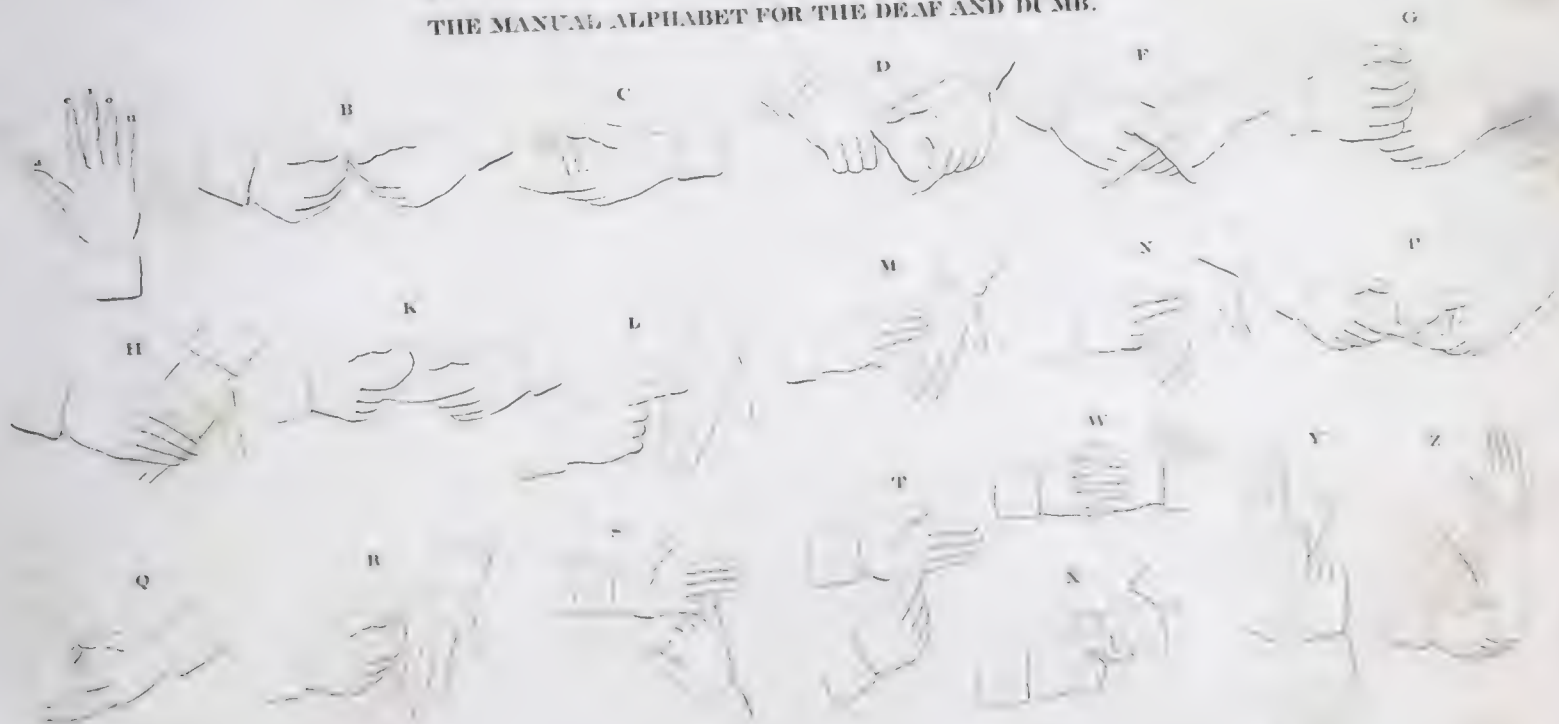
Fig. 9.







THE MANUAL ALPHABET FOR THE DEAF AND DUMB.







# DYNAMOMETER.

Fig. 1.

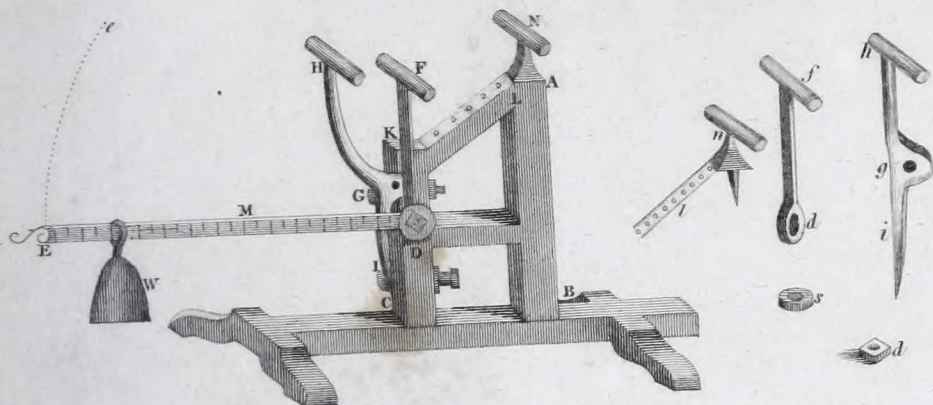


Fig. 5.

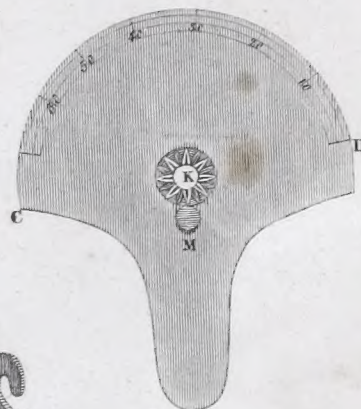


Fig. 3.

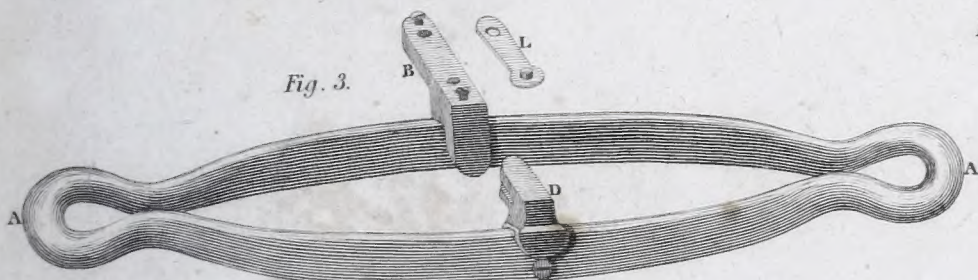


Fig. 6.

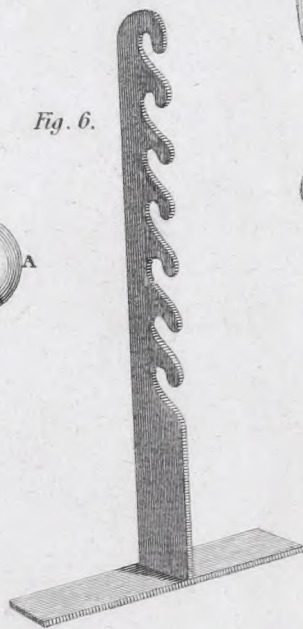


Fig. 7.



Fig. 4.



Fig. 8.



Fig. 12.

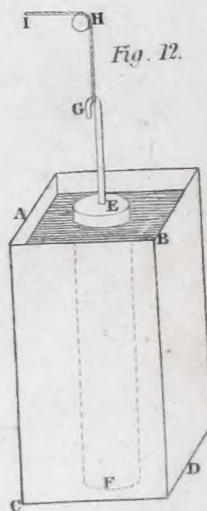


Fig. 9.

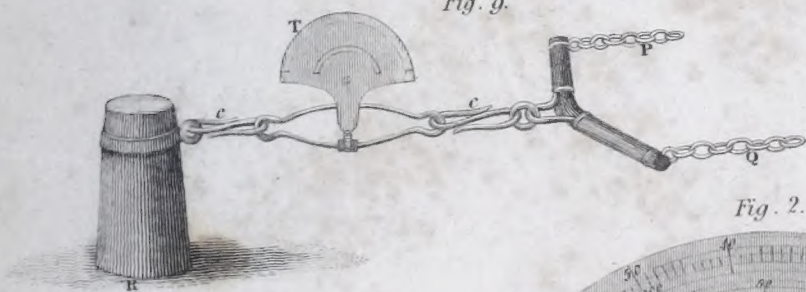


Fig. 2.



Fig. 10.



Fig. 11.



PS-1910-H



